

ISSN 1307-3729

REHVA  
**3E**

Federation of  
European Heating,  
Ventilation and  
Air Conditioning  
Associations

# The **REHVA** European HVAC Journal

Volume: 61

Issue: 1

February 2024

[www.rehva.eu](http://www.rehva.eu)



## **Decarbonisation & changing climate - Nordic solutions**



**Small devices,  
big impact.**

## **Optimise the energy performance of your building.**

Buildings and their usage are responsible for 40% of global energy demand and greenhouse gas emissions. Using the Belimo product portfolio which enables highly energy-efficient building automation and control systems, it is possible to cut the energy requirements of HVAC solutions by up to 55%. At the MCE 2024 we invite you to discover how you can make a positive impact on the CO<sub>2</sub> footprint and your energy costs by unlocking the potential of your HVAC system.

Visit us to discover the goldmines hidden in your building.



**Pavilion 7, booth A31 – A35  
Meet us at MCE 2024**



**BELIMO Automation AG**  
info@belimo.ch, www.belimo.com

**BELIMO®**

**Editor-in-Chief:**

Jaap Hogeling  
jh@rehva.eu

**Editorial Assistant:**

France Baggetto  
fb@rehva.eu

**General Executive:**

Ismail Ceyhan, Turkey

**REHVA BOARD**

**President:**

Cătălin Lungu

**Vice Presidents:**

Kemal Gani Bayraktar  
Lada Hensen Centnerová  
Risto Kosonen  
Ivo Martinac  
Livio Mazzarella  
Pedro Vicente-Quiles  
Johann Zirngibl

**EDITORIAL BOARD**

Murat Cakan, Turkey  
Guangyu Cao, Norway  
Tiberiu Catalina, Romania  
Francesca R. d'Ambrosio, Italy  
Ioan Silviu Dobosi, Romania  
Lada Hensen, The Netherlands  
Karel Kabele, Czech Republic  
Risto Kosonen, Finland  
Jarek Kurnitski, Estonia  
Livio Mazzarella, Italy  
Dejan Mumovic, United Kingdom  
Ilinca Nastase, Romania  
Natasia Nord, Norway  
Dusan Petras, Slovakia  
Olli Seppänen, Finland  
Branislav Todorovic, Serbia  
Peter Wouters, Belgium

**CREATIVE DESIGN AND LAYOUT**

Jarkko Narvanne, jarkko.narvanne@gmail.com

**ADVERTISEMENTS**

Marie Joannes, mj@rehva.eu

**SUBSCRIPTIONS AND  
CHANGES OF ADDRESSES**

**REHVA OFFICE:**

Washington Street 40  
1050 Brussels, Belgium  
Tel: +32-2-5141171  
info@rehva.eu, www.rehva.eu

**PUBLISHER**

TEKNIK SEKTÖR YAYINCILIĞI A.Ş.  
Fikirtepe Mah., Rüzgar Sk. No: 44C  
A3 Blok, Kat:11 D:124 Kadıköy/İstanbul, Turkey

REHVA Journal is distributed in over 50 countries through the Member Associations and other institutions. The views expressed in the Journal are not necessarily those of REHVA or its members. REHVA will not be under any liability whatsoever in respect of contributed articles.

Cover photo: Aalto University, photo by Mikko Raskinen

*Contents*

Download the articles from [www.rehva.eu](http://www.rehva.eu) -> REHVA Journal

**EDITORIAL**

- 4 Nordic issue editorial**  
Risto Kosonen

**ARTICLES**

- 5 The effect of urban microenvironment on indoor temperatures in Helsinki region**  
Iliia Kravchenko, Azin Velashjerdi Farahani, Risto Kosonen & Simo Kilpeläinen

- 10 Field measurement indicates overheating in Finnish apartments during hot summer weather conditions**  
Azin Velashjerdi Farahani, Risto Kosonen & Juha Jokisalo

- 14 Thermal storage capacity in the entire building stock of Denmark for energy flexibility strategies and building-to-grid services**  
Hicham Johra, Maxime Goupy & Kim B. Wittchen

- 18 Real energy use and indoor air quality in a low energy residential building in Norway**  
Natasia Nord

- 21 Digitalisation as a potential game changer to foster energy efficiency in the building stock**  
Markus Schaffer, Judith Fauth, Hicham Johra, Daniel Leiria, Anna Marszal-Pomianowska & Michal Pomianowski

- 26 Field investigation of indoor air quality in one Norwegian apartment building with burning candles**  
Azimil Alam, Jules Nacinovi, Kasper Oppi, Thibault Lose & Guangyu Cao

- 31 Investigation of whether elderly people can benefit from local cooling devices in warm environments**  
Minzhou Chen, Azin Velashjerdi Farahani, Risto Kosonen & Simo Kilpeläinen

- 35 Leveraging Artificial Intelligence in Indoor Air Quality Management: A Review of Current Status, Opportunities, and Future Challenges**  
Sasan Sadrizdeh

- 39 Indoor Environment in Arctic Dwellings and Possible Improvements – With Special Focus on Overheating**  
Alexandr Baron, Florian Rigal & Martin Kotol

- 45 The characteristics of airborne transmission with convective and radiant cooling systems**  
Weixin Zhao, Simo Kilpeläinen, Risto Kosonen & Juha Jokisalo

- 49 Demand response of space heating for a district heated office building in Finland**  
Yuchen Ju, Pauli Hiltunen, Juha Jokisalo, Risto Kosonen & Sanna Syri

- 53 Long-term performance analysis of a hybrid ground source heat pump system in Finland**  
Tianchen Xue, Risto Kosonen & Juha Jokisalo

- 58 Performance evaluation of a Heat Valve ventilation and heating system for residential buildings**  
Alireza Afshari, Göran Hultmark & Joanna Polak

- 61 Commissioning process is required to guarantee high performance of hybrid systems**  
Johannes Simola, Risto Kosonen & Simo Kilpeläinen

- 65 Scaling Machine Learning for building operational phase**  
Davor Stjelja

**REHVA WORLD**

- 69 AICVF conference: Attractiveness of HVAC professions for young people and feminization**

- 70 REHVA supports actively Heat pump standardisation at European Level**

**EVENTS & FAIRS**

- 72 Exhibitions, Conferences and Seminars**

- 73 The 43rd MCE - Mostra Convegno Expocomfort**

*Advertisers*

- ✓ BELIMO ..... 2 ✓ REHVA MEMBERS ..... 74  
✓ EUROVENT CERTITA CERTIFICATION ..... 38 ✓ REHVA SUPPORTERS ..... 75  
✓ WORLD SUSTAINABLE ENERGY DAYS 2024. 44 ✓ REHVA GUIDEBOOK ..... 76  
✓ LGe ..... 71

*Next issue of REHVA Journal*

Instructions for authors are available at [www.rehva.eu](http://www.rehva.eu) (> Publications & Resources > Journal Information). Send the manuscripts of articles for the journal to Jaap Hogeling [jh@rehva.eu](mailto:jh@rehva.eu).

# Nordic issue editorial

We have started to talk more often about Planetary Health. Planetary Health is a solutions-oriented, transdisciplinary field and social movement focused on analysing and addressing the impacts of human disruptions to Earth's natural systems on human health and all life on Earth. As HVAC engineers, our task in planetary wellbeing is to improve energy efficiency and simultaneously guarantee a healthy and comfortable indoor climate.

At the moment, we have some challenges. The ongoing Russo-Ukrainian war and the climate crisis have revealed the vulnerability of societies to fluctuations in the availability and price of energy and power. The need to secure the EU's independence from fossil fuels and the climate crisis urgently push the transformation of Europe's energy systems. Measures are required to respond to this ambition through the accelerated roll-out of renewables. To support a fast deployment of renewable energy solutions to end the dependency of the EU on fossil fuels, the path of reducing energy demand, decarbonizing power supply, heating and cooling, and addressing the carbon footprint of building materials was presented in the frame of European Green Deal, the Renovation Wave, Energy Roadmap 2050 and REPowerEU plan.

In Nordics, energy efficiency and indoor climate have been for years in the focus of the construction and real estate industry. In a cold and severe cold climate, it is natural to focus on the heating system and indoor conditions, when persons spend more than 90% of their time indoors. Nowadays, we have realized that

climate change creates an overheating problem in our residential buildings when the pace of climate change in high latitudes is two times more rapid than in the global average. This we have lately noticed when we have had during the last 10 years four exception hot summers.

The selected articles in this issue are from a group of scientists in Nordic countries that have close cooperation with SCANVAC and different REHVA task forces. The articles give an overview of the ongoing research focus areas in Nordics. There are articles e.g. dealing with hybrid heating, energy storage, demand response, indoor climate, air distribution, and utilization of artificial intelligence and machine learning.

I believe that this Nordic Issue of the REHVA Journal gives you some new ideas and practical Nordic solutions on how to enhance the resiliency of buildings, reduce the risk of infection, and reduce the risk of overheating in residential buildings also in temperature climates. With the solutions presented, we can also partly help to enhance planetary health and sustainability of the society. ■



**RISTO KOSONEN**  
SCANVAC President &  
Vice-President of REHVA

## REHVA EXPERT TALK AT LIGHT & BUILDING

Data Driven Smart Buildings

light+building



March 8th, 2024



Frankfurt, Germany

REHVA  
3E



# The effect of urban microenvironment on indoor temperatures in Helsinki region



**ILIA KRAVCHENKO**  
Doctoral candidate,  
Aalto University  
ilia.kravchenko@aalto.fi



**AZIN VELASHJERDI FARAHANI**  
Doctoral candidate,  
Aalto University



**RISTO KOSONEN**  
Full-Professor,  
Aalto University



**SIMO KILPELÄINEN**  
D.Sc., laboratory manager,  
Aalto University

The influence of the urban microenvironment on indoor air temperature was studied. The large dataset of over 2000 apartments in the Helsinki region was analyzed during the heat waves of 2018 and 2021. Buildings were clustered into groups by geographical location, green view index, floor area ratio and distance from the sea. The results showed that the urban microenvironment had a maximum of up to 1°C effect on indoor air temperature. The green view index and distance from the sea had both the strongest temperature-reducing effect of about 0.5°C. The urban microenvironment factors had a lesser impact during long heatwaves and the most significant impact was during short heatwaves.

**Keywords:** urban microenvironment, residential buildings, overheating, heatwave, indoor air temperature

## Extreme weather conditions in changing Nordic climate

Due to climate change extreme weather events are becoming more frequent and severe, resulting in local heatwaves and, subsequently, overheating of residential buildings [1,2]. Overheating of residential building stock can adversely affect the quality of rest and health, especially during severe heat waves [3,4].

Mechanical cooling is not commonly implemented in the Finland residential building stock, as the cooling period has been rather short, and the buildings are designed to have high insulation and airtightness due to cold weather conditions [5–9]. Because of this, in the summertime with extreme weather conditions, buildings are less capable of dissipating heat during the nighttime if the outdoor environment temperature

stays quite high. For instance, the year 2050 heatwave scenario, will bring about 3000 degree hours above 32°C indoor temperature of building stock [10]. Hence, it becomes essential to make buildings more resilient for hot summers and to prevent overheating.

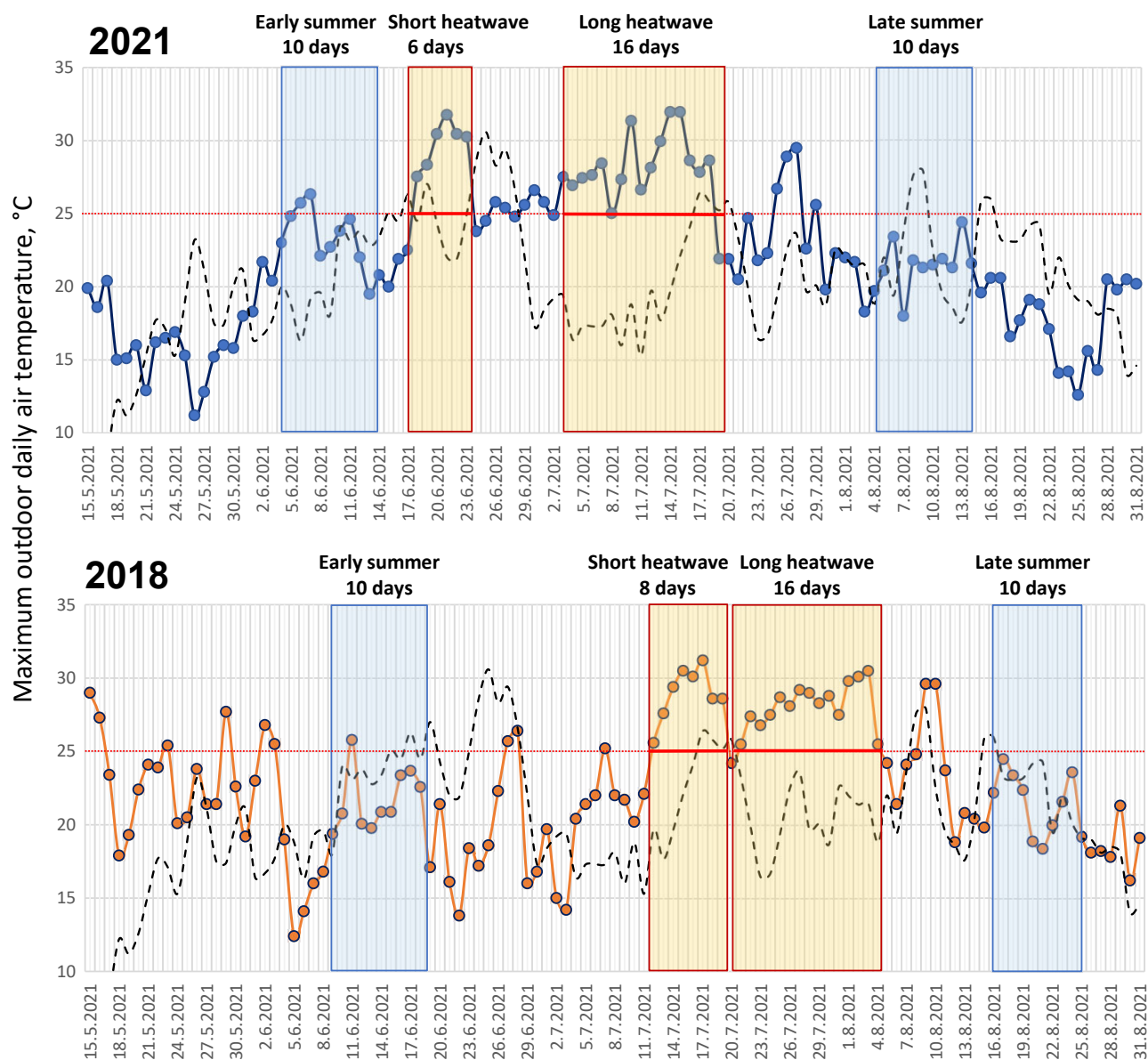
There are several main factors contributing to building stock overheating – weather and such complex phenomena as the urban heat island (UHI) effect. It shows a correlation with urbanization, high direct and indirect solar radiation (solar insolation reflection), low urban vegetation level and high floor area ratio [11,12]. The overheating risk, brought by UHI, could be prevented on the district level with wise urban microenvironment design: urban vegetation, open water sources and low-emission building envelope.

## Analyzed heat waves and selected urban microenvironment factors

The study focuses on the effect of the urban microenvironment parameters in Nordic conditions during the summer and severe heat waves of 2018 and 2021. For the analysis different heat wave periods were chosen: early summer, and late summer. The green view index (GVI), floor area ratio (building's floor area in relation to the size of the lot/parcel that the building is located on) and building distance from sea were chosen to represent microenvironment parameters. The large dataset allows analysis of urban microenvironment factors. The factors were distinguished from others by clustering close-situated building groups with the same factors, averaging the influence of others. The effect of urban microenvironment parameters on indoor air temperature was calculated for each period separately.

In Finland, the heatwaves were defined as hot days when a maximum hourly temperature exceeded 25°C. In this analysis, the periods were chosen accordingly (see Fig.1):

- The first period was in the early summer, characterized by typical warm early summer days.
- The second period was a short heat wave transitioning from a normal summer day to a hot day.
- The third period was a long heat wave in mid-summer. The urban environment and seawater were already warmed up.
- The fourth period was in late summer. The urban and natural environment was still warm after summer.



**Figure 1.** Daily maximum outdoor temperature distribution and the chosen four time periods in both years 2018 and 2021 and dashed line for 2020 average year.

In this study, 400 buildings with more than 2000 apartments in Helsinki were chosen for analysis, see Fig.2. In each building, from 3 to 6 apartments are equipped with indoor air temperature sensors.

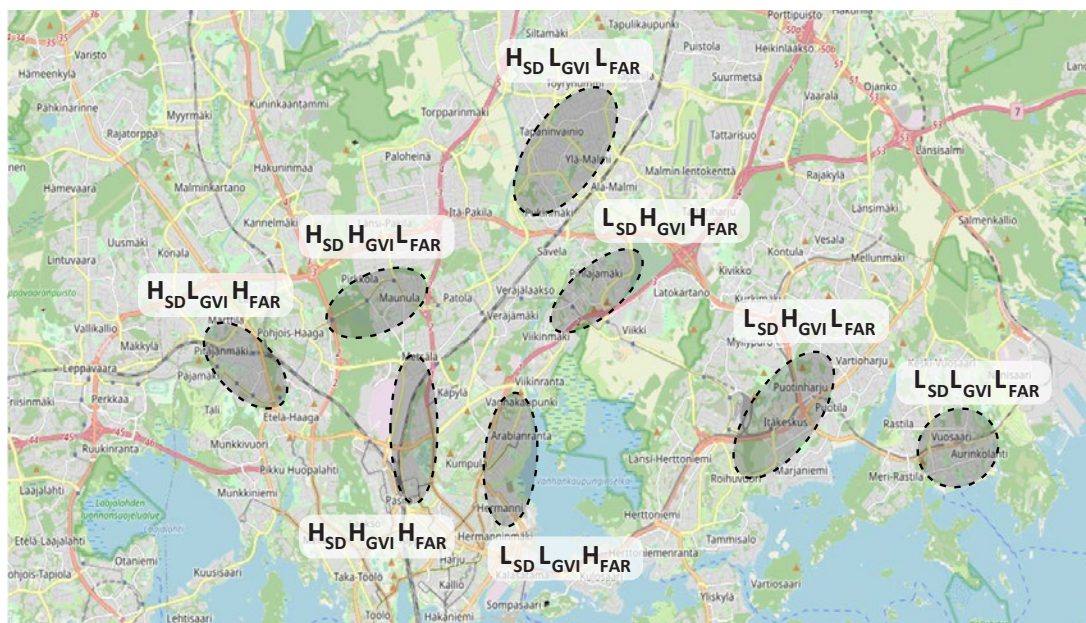
Based on the building's location, additional information about the local urban microenvironment was obtained based on open sources:

- Green view index (GVI) - the index describes the level of vegetation on the sides of the street, the shading of trees and surrounding buildings. Helsinki has on average a GVI of 50.
- Floor area ratio (FAR) - the index describes the urbanization of areas and is a combination of average built-up area and the height of the buildings. The data has a resolution of 100 meters by 100 meters, and the value of the FAR was calculated based on the nearest grid cell from the geometric

centre of the building. The level of urbanization and building density is quite low in Helsinki corresponding to single-entrance 6-storey buildings for a square of 100 m by 100 m.

- Distance from the sea (SD) - this parameter reflects the effect of the seawater temperature.

After analysis of indexes, the lowest 25% of values were defined as a “Low” level of index, and the highest 25% were defined as “High”. The buildings between “High” and “Low” were not used further in the analysis. Geographically closely located buildings were clustered with the same extreme (High or Low) indexes. These buildings then formed building groups, which on average represent the influence of the allocated combination of three selected urban parameters: GVI, FAR and SD. The building was grouped to neglect building characteristics (construction year, orientation etc.)



Acronyms Groups	Sea distance	Green view index	Floor area ratio	Number of buildings	Number of apartments
H <sub>SD</sub> H <sub>GVI</sub> H <sub>FAR</sub>	High	High	High	29	112
H <sub>SD</sub> L <sub>GVI</sub> L <sub>FAR</sub>	High	Low	Low	17	73
H <sub>SD</sub> H <sub>GVI</sub> L <sub>FAR</sub>	High	High	Low	17	77
L <sub>SD</sub> H <sub>GVI</sub> L <sub>FAR</sub>	Low	High	Low	18	91
L <sub>SD</sub> H <sub>GVI</sub> H <sub>FAR</sub>	Low	High	High	19	102
L <sub>SD</sub> L <sub>GVI</sub> H <sub>FAR</sub>	Low	Low	High	17	82
H <sub>SD</sub> L <sub>GVI</sub> H <sub>FAR</sub>	High	Low	High	20	103
L <sub>SD</sub> L <sub>GVI</sub> L <sub>FAR</sub>	Low	Low	Low	17	81

**Figure 2.** Geographical locations of the building groups that were clustered with green view index (GVI), sea distance (SD) and floor area ratio (FAR).

## Whole summer

The effect of the urban microenvironment was analysed on the average indoor temperature during the whole summer. The temperature difference is shown to depict the relative performance of the factors, see **Fig.3 (a)**. The GVI and SD were dominant factors and FAR had a lower influence. The groups indoor temperature difference in **Fig.3 (a)** showed similar patterns of performance in 2018 and 2021 in most cases.

The maximum effect of the urban microenvironment was about 1.0°C between the coolest and warmest groups. The group with the lowest temperature had a high green view index (GVI), high sea distance (SD) and low floor area ratio (FAR). The group with the highest temperature had low GVI, low SD and high FAR, see **Fig.3 (b)**. The groups with low SD, high GVI and low FAR showed the best temperature-reducing abilities. Although the average effect was around 0.2°C, it was consistent throughout the whole summer period.

The GVI had the highest temperature-reducing factor due to the fact, that greenery in summer always provides shading for the buildings and surroundings and evapotranspiration combined with reducing short-wave radiation.

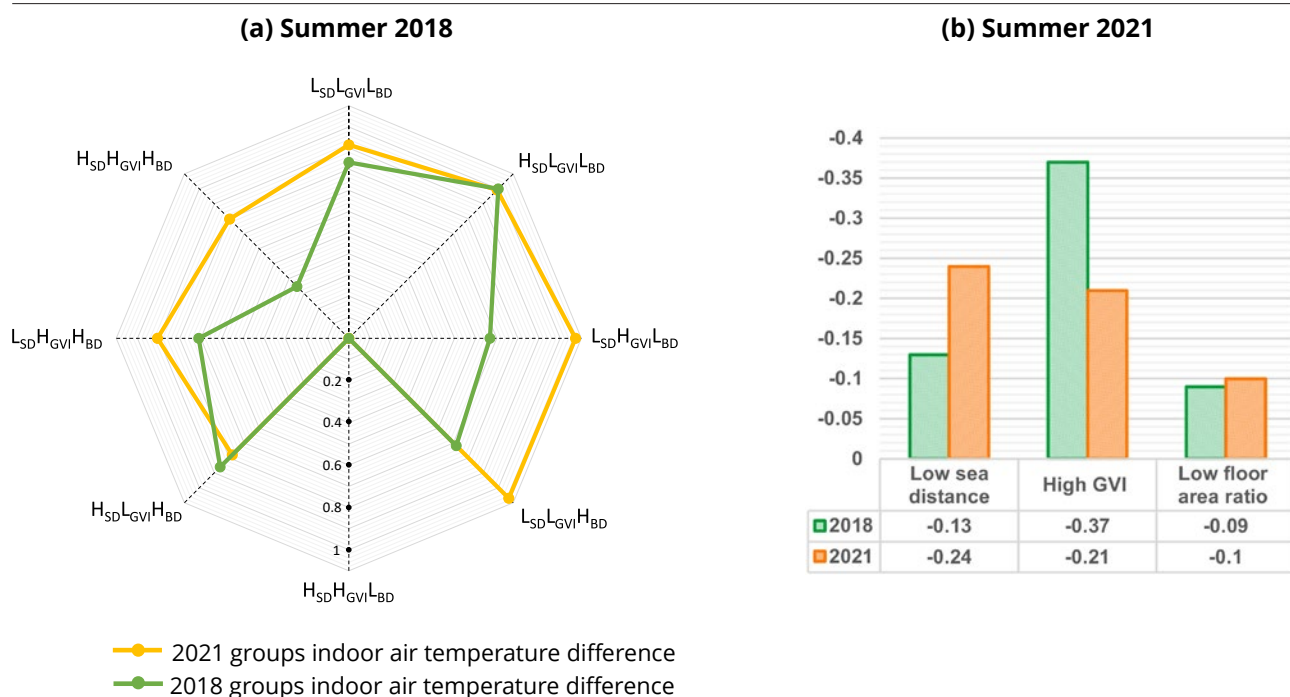
The sea distance e.g. sea temperature had more effect during 2021 due to the seawater temperature difference with high average summer air temperatures during that year.

## Short and long heatwaves

In the early summer high GVI significantly reduced the temperature in the building groups during both years. The low SD had a lower temperature-reducing effect but was comparable to the high GVI effect during both years. The effect of low FAR varied in different years; the temperature reduced in 2018 and increased in 2021. The combination of FAR and GVI had a limited effect on the indoor air temperature. The combination of SD and GVI was predominant. The temperature difference between the best and worst-performing groups was substantial. The most likely reason for that is the influence of building thermal mass; nights were still cool and free cooling of ventilation with cool outdoor air and openable windows are able to cool room spaces.

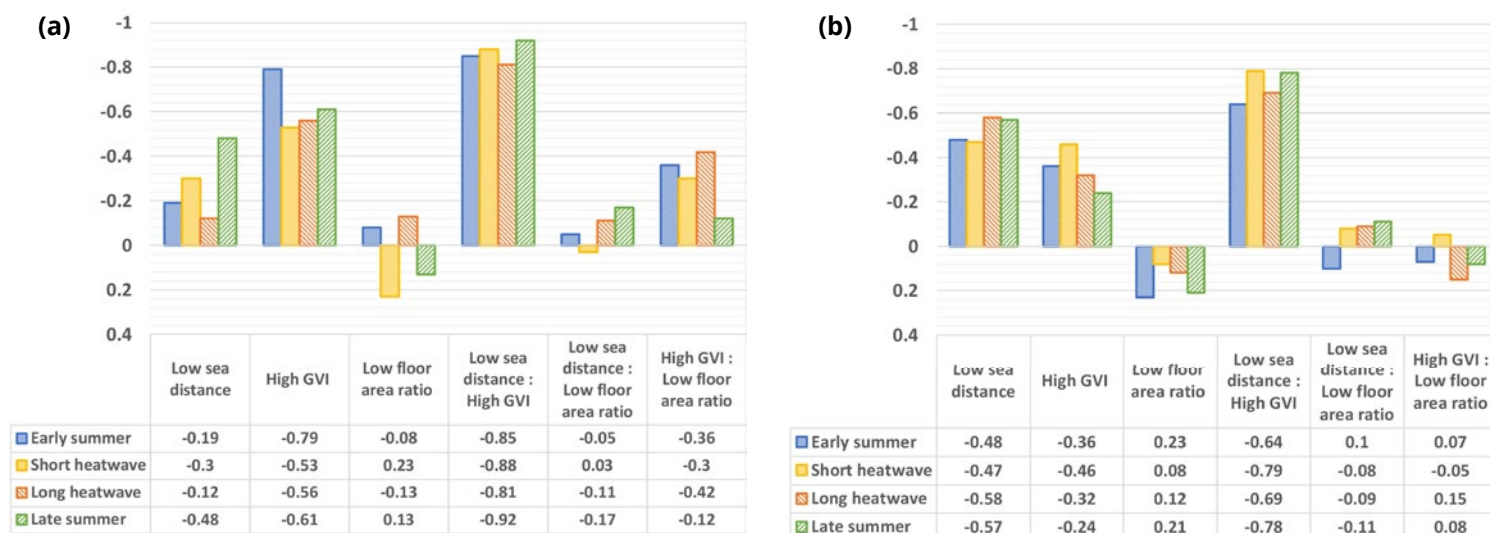
During the first short heatwave, which happened in the middle of the summer, the low SD and the high GVI were the most significant temperatures. High GVI combined with a low FAR had a less significant effect.

The performance during long heatwaves showed that in 2018 the high GVI was the most temperature-reducing, due to the ability to mitigate shortwave radiation and the cooling effect of evapotranspiration regardless of high outdoor temperature. In 2021, the sea effect was high since the outdoor environment was not heated so much. The relative difference between groups was lowest among all time periods, as the thermal mass of the building was already warmed up.



**Figure 3.** The relative and absolute differences in indoor air temperature between building groups during the whole summer **(a)**, the effect of individual microenvironment factors on indoor temperature in the whole summers of 2018 and 2021 **(b)**.





**Figure 4.** The effect of microenvironment factors on indoor temperatures during different heat wave periods in 2018 (a) and 2021 (b).

The low FAR reduced the temperature only with a combination of high GVI.

The group performance during the late summer was very similar to early summer, but the temperature difference between groups was higher due to nights already being colder.

## Conclusions

Analysis revealed that long heatwaves significantly reduced the influence of urban microenvironment parameters and necessitated alternative approaches for passive or active cooling and urban parameters have a limited effect on indoor temperatures during the whole summer, but they can have a more significant role during shorter heatwaves. ■

## References

- [1] G. Ulpiani, On the linkage between urban heat island and urban pollution island: Three-decade literature review towards a conceptual framework, *Science of The Total Environment*. 751 (2021) 141727. <https://doi.org/10.1016/j.scitotenv.2020.141727>.
- [2] S. Chapman, J.E.M. Watson, A. Salazar, M. Thatcher, C.A. McAlpine, The impact of urbanization and climate change on urban temperatures: a systematic review, *Landscape Ecol.* 32 (2017) 1921–1935. <https://doi.org/10.1007/s10980-017-0561-4>.
- [3] D. Chen, Overheating in residential buildings: Challenges and opportunities, *Indoor and Built Environment*. 28 (2019) 1303–1306. <https://doi.org/10.1177/1420326X19871717>.
- [4] N. Nazarian, E.S. Krayenhoff, B. Bechtel, D.M. Hondula, R. Paolini, J. Vanos, T. Cheung, W.T.L. Chow, R. de Dear, O. Jay, J.K.W. Lee, A. Martilli, A. Middel, L.K. Norford, M. Sadeghi, S. Schiavon, M. Santamouris, Integrated Assessment of Urban Overheating Impacts on Human Life, *Earth's Future*. 10 (2022) e2022EF002682. <https://doi.org/10.1029/2022EF002682>.

- [5] B.W. Olesen, Indoor Environment Criteria for Design and Calculation of Energy Performance of Buildings EN15251, in: *The 6th International Conference on Indoor Air Quality, Ventilation & Energy Conservation in Buildings: Sustainable Built Environment*, 2007. <https://orbit.dtu.dk/en/publications/indoor-environment-criteria-for-design-and-calculation-of-energy-> (accessed December 25, 2020).
- [6] N. Brelih, O. Seppanen, Ventilation rates and IAQ in European standards and national regulations, *Proceedings of the 32nd AIVC Conference and 1st TightVent Conference in Brussels*. (2011).
- [7] Fernbas, Energy performance of buildings directive, Energy - European Commission. (2019). [https://ec.europa.eu/energy/topics/energy-efficiency/energy-efficient-buildings/energy-performance-buildings-directive\\_en](https://ec.europa.eu/energy/topics/energy-efficiency/energy-efficient-buildings/energy-performance-buildings-directive_en) (accessed November 5, 2020).
- [8] The National Building Code of Finland, Ympäristöministeriö. (n.d.). <https://ym.fi/en/the-national-building-code-of-finland> (accessed November 11, 2020).
- [9] Decree of the Ministry of the Environment on the Indoor Climate and Ventilation of New Buildings 1009/2017, (2017).
- [10] A. Velashjerdi Farahani, J. Jokisalo, N. Korhonen, K. Jylhä, K. Ruosteenoja, R. Kosonen, Overheating Risk and Energy Demand of Nordic Old and New Apartment Buildings during Average and Extreme Weather Conditions under a Changing Climate, *Applied Sciences*. 11 (2021) 3972. <https://doi.org/10.3390/app11093972>.
- [11] S.W. Kim, R.D. Brown, Urban heat island (UHI) variations within a city boundary: A systematic literature review, *Renewable and Sustainable Energy Reviews*. 148 (2021) 111256. <https://doi.org/10.1016/j.rser.2021.111256>.
- [12] C. O'Malley, P. Piroozfar, E.R.P. Farr, F. Pomponi, Urban Heat Island (UHI) mitigating strategies: A case-based comparative analysis, *Sustainable Cities and Society*. 19 (2015) 222–235. <https://doi.org/10.1016/j.scs.2015.05.009>.
- [13] H. Akeiber, P. Nejat, M.Z. Abd. Majid, M.A. Wahid, F. Jomehzadeh, I. Zeynali Famileh, J.K. Calautit, B.R. Hughes, S.A. Zaki, A review on phase change material (PCM) for sustainable passive cooling in building envelopes, *Renewable and Sustainable Energy Reviews*. 60 (2016) 1470–1497. <https://doi.org/10.1016/j.rser.2016.03.036>.

# Field measurement indicates overheating in Finnish apartments during hot summer weather conditions



**AZIN VELASHJERDI FARAHANI**

Doctoral candidate,  
Aalto University  
azin.velashjerdifarahani@aalto.fi



**RISTO KOSONEN**

Full-Professor,  
Aalto University



**JUHA JOKISALO**

Senior researcher,  
Aalto University

The overheating risk was assessed in over 6000 apartments to show indoor overheating during the hot summer in Finland. The findings indicated that during the hot summer, almost all the apartments' indoor temperatures were above 27°C, and one-third of them were above 30°C. New apartments constructed based on the latest building code demonstrated lower overheating risks during the hot summer.

**Keywords:** Overheating risk, Hot summer, Apartment buildings, Field study, Climate change, Heatwave

## Climate change and associated heatwaves

Anthropogenic emissions of greenhouse gases into the atmosphere are increasing global mean temperature [1]. In Finland, a cold-climate Northern country, this warming trend is around two times higher than the global temperature increase [2]. Additionally, global warming is associated with extreme temperatures [3]. The four longest recorded heatwaves in Finland occurred in 2010, 2014, 2018, and 2021 [4]. Projections under the Representative Concentration Pathway (RCP) 4.5 climate model showed an increase in the frequency, intensity, and duration of heatwaves [5]. This can lead to high indoor overheating risks and cause lung malfunctions, blood flow disorders in the human body, cardiovascular diseases, and increase

population mortality [6]. In Finland, the premature mortality rate increased among the elderly during heatwaves [7].

## Overheating assessment in the apartments

While some level of overheating was observed during the average summer of 2020, significantly higher levels of overheating were experienced during the hot summer of 2021. As **Fig. 1** shows, the average degree hours above 27°C during the summer of 2021 were approximately three times higher than in the average summer of 2020. The dataset for room air temperatures was obtained from field measurements conducted in apartments in the Helsinki region, Finland. The data

consisted of 6974 apartments with hourly data from May 15th to August 31st, 2020, and 6057 apartments from a similar period in 2021.

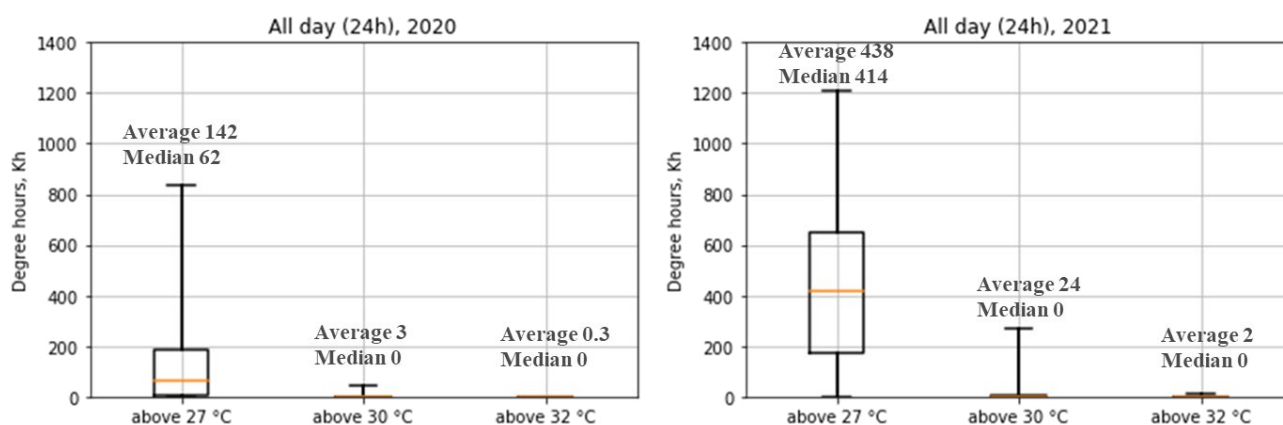
The degree hours above 27°C in 2021 was higher than 150 Kh which is based on the requirements of the Ministry of the Environment of Finland for new apartment buildings (Ministry of Environment, 2018). This 150 Kh threshold value can be applied in apartments with or without mechanical cooling with all kinds of ventilation systems including natural or mechanical ones.

Moreover, nearly all apartments had maximum hourly temperatures exceeding 27°C throughout the entire summer as **Fig. 2** shows. The overheating levels during the relaxing time (21-8) were quite similar to the

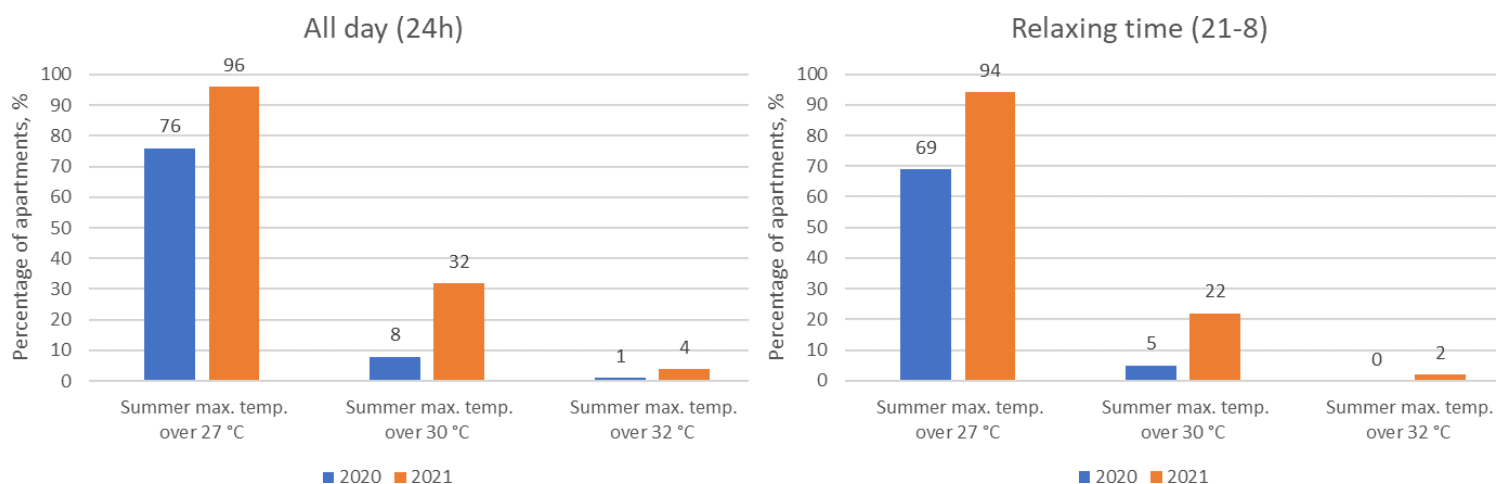
overheating during all day in terms of degree hours above 27°C. However, there are almost no degree hours above 32°C during the nights of both summers.

### Overheating risks and apartments' age and area

These apartments were constructed between 1902 and 2016. They were clustered into 5 different age categories based on Finnish building code requirement changes. The group, before 1977 represents a period when there was no building code and no requirements for energy efficiency [8]. The first building code came into force in 1977 and set regulations for U-values of the building envelope [9]. In 2003, the regulations for window U-values changed along with a new demand for heat recovery for ventilation [10], [11]. Moreover, the mechanical exhaust ventilation



**Figure 1.** Degree hours above 27°C, 30°C, and 32°C for 98% of the apartments during the whole summer of 2020 and 2021.



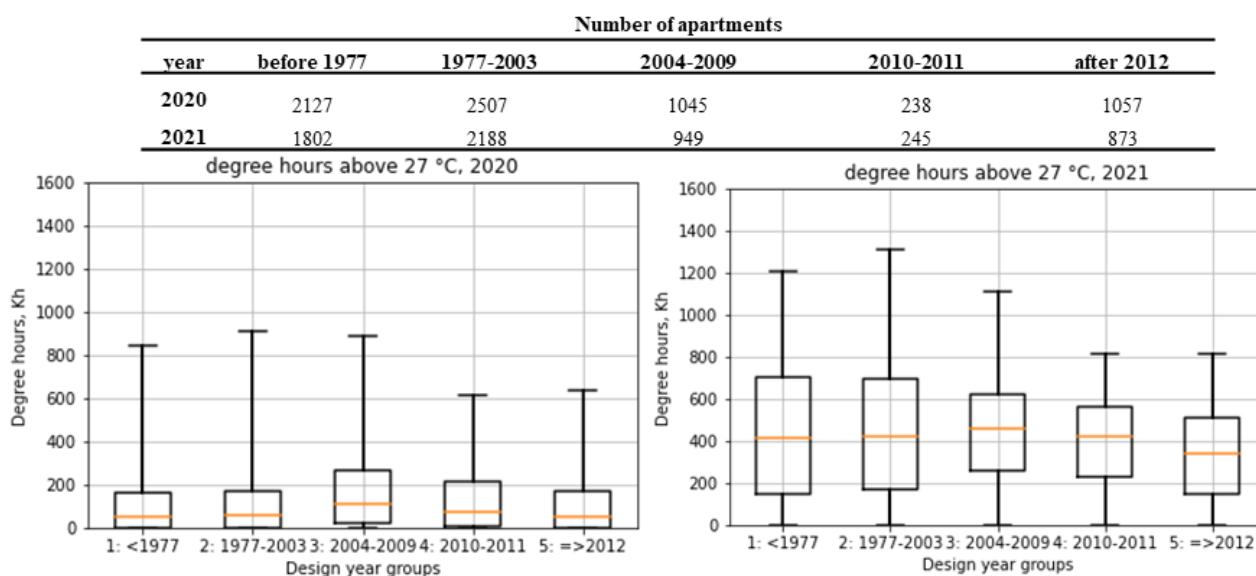
**Figure 2.** The percentage of apartments with the maximum hourly temperature of the summer above 27°C, 30°C, and 32°C. 6974 apartments in 2020 and 6056 apartments in 2021 are analyzed.

systems without heat recovery changed to mechanical balanced ventilation systems with heat recovery in the buildings designed after 2003 [10], [11]. After that, the simple U-value requirements ended and the new building code in 2010 started to use requirements for total heat losses through the envelope (heat conduction and infiltration) and ventilation [12].

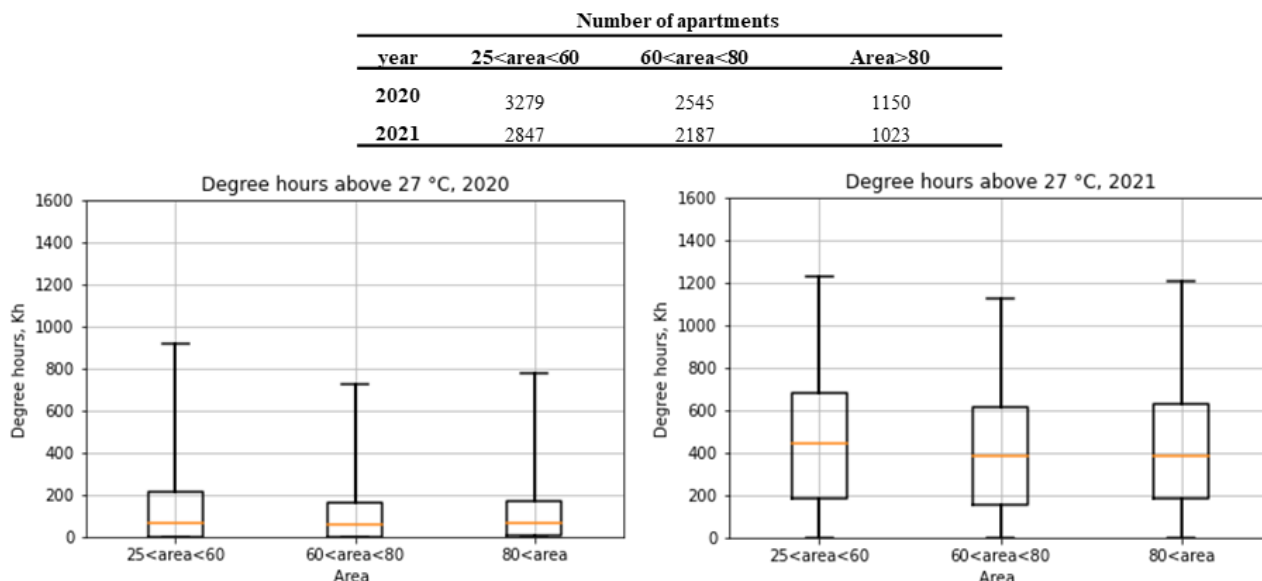
**Fig. 3** shows the degree hours above 27°C in different design year groups. The apartments designed based on the latest Finnish building code have a lower risk of overheating with statistically significant differences

compared to older apartments. This shows the effectiveness of the latest building codes that require proofed degree hours above 27°C to be lower than 150 Kh during June-August in the new apartment buildings using simulations.

The area of these apartments varied between 20 to 232 m<sup>2</sup>. **Fig. 4** shows the degree hours above 27°C in different area groups. As can be seen, the smaller apartments were at a slightly higher risk of overheating with statistically significant differences compared to the ones with a larger area.



**Figure 3.** Degree hours above 27°C, 30°C, and 32°C for different design year categories.



**Figure 4.** Degree hours above 27°C, 30°C, and 32°C for different area groups.

## Conclusions

This study, along with other research conducted in different climates, demonstrates the significant severe overheating in residential spaces of cold climates during heatwaves in the current climate. Although the risk is lower in new apartments designed to mitigate overheating based on the latest Finnish building code, there is an urgent need for actions to prevent indoor summertime overheating. With the rising effects of climate change and its associated heatwaves, these actions could

encompass revising design principles in light of climate change, implementing passive strategies and mechanical cooling systems, and imparting education to occupants on their role in averting indoor overheating. ■

## References

Please find the complete list of references in the html-version at <https://www.rehva.eu/rehva-journal>

## UPCOMING EVENT

📅 5 - 8 March 2024 | 📍 Wels, Austria | 🌐 [www.wsed.at](http://www.wsed.at)

# The World Sustainable Energy Days 2024

## Energy transition now – fast, smart, resilient!

**“Energy transition now – fast, smart, resilient!” This is the focus of the next World Sustainable Energy Days (WSED) in Wels/Austria from 5 – 8 March 2024.**

**N**o time like now for the energy transition! Price fluctuations, geopolitical instabilities and the climate crisis make the importance of the energy transition evident. New EU targets require a strong push for energy efficiency and renewable energy in all sectors.

In 2024, the WSED focuses on how to realise the high policy ambitions and strengthen demand and markets for sustainable energy.

### A comprehensive package

The WSED are a leading international conference on achieving climate neutrality that attracts 600+ participants from more than 60 countries each year. They offer 6 dedicated conferences covering policies, markets, financing, e-mobility, industrial decarbonisation and more as well as the chance to present your projects and discuss new collaborations!

### Conferences and events

- Energy Efficiency Policy Conference
- Industrial Energy Efficiency Conference
- European Pellet Conference
- Smart E-Mobility Conference
- Young Energy Researchers Conference
- Workshop “Cities and regions”
- Poster Presentation
- Tradeshow

### Upper Austria – a leader in the clean energy transition

The WSED are organised by the OÖ Energiesparverband, the energy agency of Upper Austria. Upper Austria, one of Austria’s 9 regions, is well on its way in the clean energy transition. Through significant increases in energy efficiency and renewables, greenhouse gas emissions from buildings were reduced by 39%. 60% of all space heating and 33% of the primary energy in the region already come from renewables. Over 2.8 billion Euro are invested annually in the energy transition.

📅 **Mark your calendar for 5 – 8 March 2024** and join REHVA and the worldwide energy transition community at the World Sustainable Energy Days!



# Thermal storage capacity in the entire building stock of Denmark for energy flexibility strategies and building-to-grid services



**HICHAM JOHRA**  
Aalborg University,  
Department of the Built  
Environment, Denmark



**MAXIME GOUPY**  
Aalborg University,  
Department of the Built  
Environment, Denmark



**KIM B. WITTCHEN**  
Aalborg University,  
Department of the Built  
Environment, Denmark

Building-to-grid services by means of short-term demand response (shifting energy demand in time, peak power demand shedding or load profile reshaping) are key to decarbonising and optimising energy grids comprising an ever-growing share of intermittent renewable energy sources.

**Keywords:** Demand response, building energy flexibility, building stock thermal storage, load shifting, building-to-grid services

**B**uildings have an enormous untapped potential to perform demand response thanks to their energy flexibility. These building energy flexibility actions mainly rely on different forms of energy storage (e.g., electric batteries, water tanks) or dispatchable on-site energy supply and services. The thermal inertia of the indoor environment also holds a large energy storage capacity, which can easily be leveraged with heating/cooling temperature setpoint modulation. If this approach has proven promising for building demand response, large-scale capacity estimates are lacking. This article gives an estimate of the heat storage capacity in the indoor environment of the entire building stock in Denmark. The latter is comparable to that of all combined batteries in large fleets of electric vehicles or the entirety of industrial-size storage tanks in district heating plants. The indoor environment of the building stock is a readily available and massive thermal storage tank awaiting to be used to help the grids at minimum costs.

## Motivations

In the current challenging energy and environmental context with climate change, the need to decarbonise and electrify the different energy grids (electrical grid, district heating and cooling networks), the transition from fossil fuels to fluctuating renewable energy sources (RES) and the tightening sustainability constraints, an important paradigm shift is needed and currently initiated.

The operation of energy infrastructures is drastically changing: CO<sub>2</sub>-intensive peak power generators must be phased out while maintaining grid stability with a large share of intermittent and decentralised RES. It was demonstrated that demand-side management (i.e., the modulation of the energy demand) can alleviate the aforementioned challenges. Demand response and energy flexibility measures are short-term demand-side management strategies. They can, e.g., help stabilise voltage and frequency in electrical grids, eliminate peak power limitation and local bottlenecks in energy networks, reduce

the use of CO<sub>2</sub>-intensive peak power generators, lower costly needs for reinforcement and extension of energy infrastructures and prevent the deterioration of hydronic networks caused by the unstable operation.

Buildings are the largest energy end-users. For a long time, they were considered as immutable and non-responsive loads. In reality, the building stock can change and adapt its energy demand. It also performs sector coupling between the different energy grids and transportation. Buildings are becoming more energy efficient. Decentralised prosumers and energy communities are emerging everywhere. The future of the built environment is pointing towards grid-interactive smart buildings performing demand response to provide services to the grids and match demand and energy supply from intermittent RES (**Figure 1**).

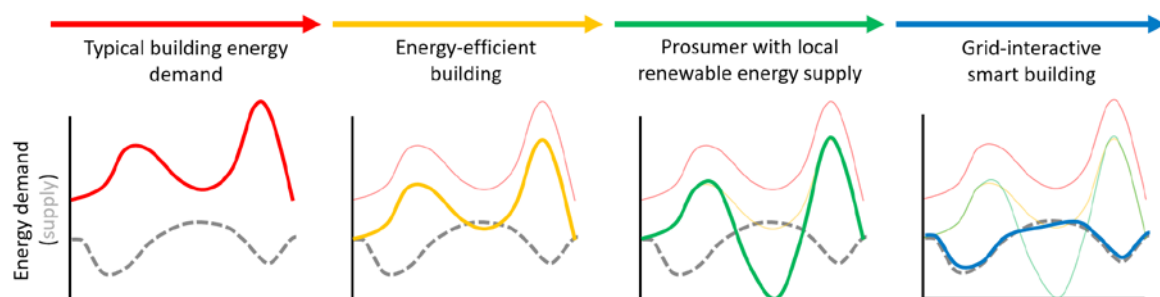
### Demand response and energy flexibility for building-to-grid services

Building energy flexibility is the ability of a building to adapt or modulate its short-term (a few hours or a couple of days) energy demand and energy generation

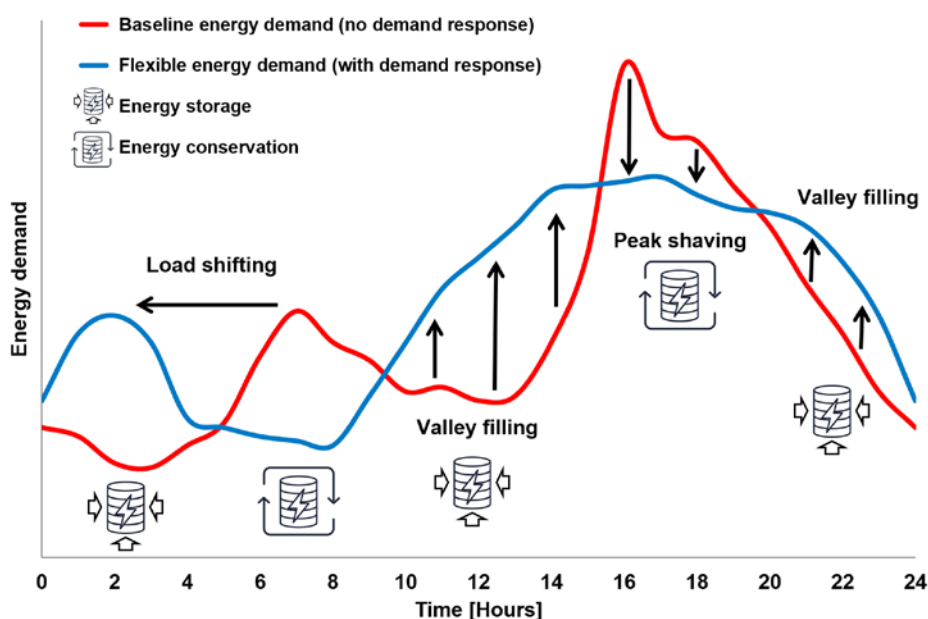
profile according to climate conditions, user needs and energy network requirements without jeopardising the technical capabilities of the building systems and the comfort of occupants [2]. Building energy flexibility/demand response thus allows load control and modulation to provide building-to-grid (B2G) services to the local energy grids and support matching the energy demand profile with the energy supply profile in smart grids dominated by RES.

The potential for buildings to provide B2G services is colossal. In Australia, it is estimated that 50% of the dispatchable capacity on the electrical grid will come from the building stock [3]. In the USA, B2G services are expected to reduce CO<sub>2</sub> emissions of the electricity grids by 6% and generate \$100-\$200 billion in cost savings by 2030 [4]. The global demand response capacity from the building stocks is currently only 1% of the total electric supply. However, it should reach 10% by 2030 [5].

As illustrated in **Figure 2**, building energy flexibility/demand response actions can consist of, e.g., peak shaving (reduction of the power peak demand),



**Figure 1.** Paradigm shift: Toward smart building-to-grid services sustainable grids dominated by RES [1].



**Figure 2.** Examples of building energy flexibility/demand response actions [6].

load shifting (anticipating or delaying the energy use over a short period of time) or valley filling (increase energy use when the energy demand is lower than the energy supply).

Many of these building demand response strategies rely on different forms of energy storage at the energy end-user side, such as electric batteries (including batteries of electric vehicles connected to a building), hot water storage tanks, phase change material storage units or ground source heat exchangers (boreholes). Demand response can also be achieved by curtailing on-site renewable energy supply (e.g., solar panels) or shifting the operation of certain appliances in time (e.g., washing machine or dishwasher).

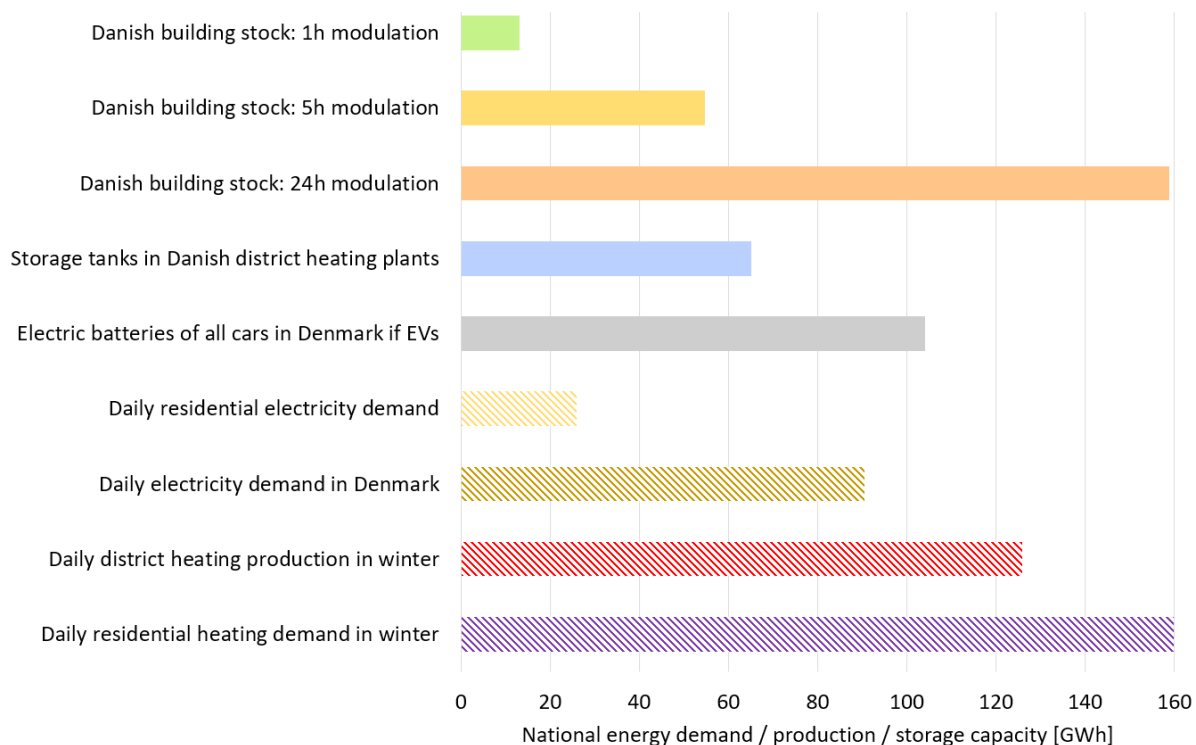
Another significant energy storage capacity of the built environment resides in the thermal inertia of the indoor environment and structural elements. This storage capacity can easily be exploited using heating/cooling indoor temperature setpoint modulation strategies. This approach has been proven promising for building demand response [7][8]. However, there is an apparent lack of large-scale thermal storage capacity estimates at entire building stock levels.

### Indoor thermal storage capacity in the entire Danish building stock to perform demand response

To remedy the limitation above, the effective thermal storage capacity of the different typologies of buildings in a given country could be estimated. Those typologies or archetypes are representative of a large number of similar buildings throughout an entire country. Combined with statistical information regarding the total number of each archetype in the whole building stock, a nationwide estimate of large-scale demand response can be made.

In the present study, pre-existing typologies for the Danish building stock [9] were expanded to calculate the indoor effective thermal inertia for each building archetype. The number of each archetype in Denmark is inferred from the national building registry. Coupling the former and the latter, one obtains an estimate of the combined thermal storage capacity in the indoor environment of the entire Danish building stock when performing heating/cooling temperature setpoint modulation.

One can see in **Figure 3** the results of the stock-scale thermal storage estimate for a temperature setpoint modulation of  $\pm 2^\circ\text{C}$  over 1 hour, 5 hours and 24 hours, respectively. One can notice the very appreciable energy storage capacity of the Danish building stock,



**Figure 3.** Thermal storage capacity in the indoor environment of the entire Danish building stock compared with key storage sources, energy demands and productions.



which is similar to that of all combined industrial-size storage tanks in district heating plants, or to that of all batteries of a fully electrified fleet of cars. This short-term energy storage capacity is also comparable to the daily electricity demand and the daily heating production during winter.

Although approximated, these results clearly highlight the massive potential for large-scale demand response of the building sector when utilising its readily existing

thermal storage capacities embedded in the indoor environment. At the moment, this indoor energy storage is vastly untapped but could easily be leveraged with the help of smart home technologies such as smart thermostats reacting to dynamic energy price signals. Indoor thermal storage by means of temperature setpoint modulation thus forms a cost-effective solution which can be combined with other sources of energy flexibility and enable buildings to counterbalance the intermittence of RES. ■

## References

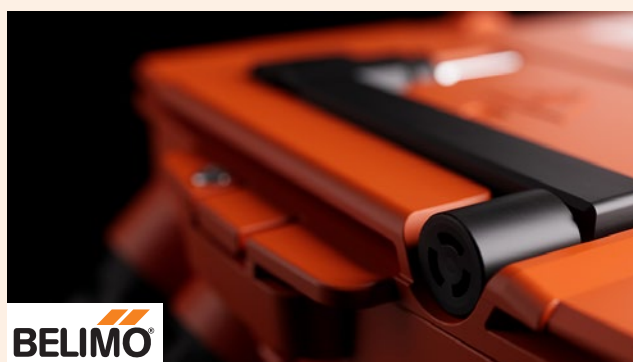
- [1] H. Johra (2023). What is building energy flexibility – demand response? DCE Lecture Notes No. 81, Department of the Built Environment, Aalborg University. <https://doi.org/10.54337/aa518320296>.
- [2] S.Ø. Jensen, A. Marszal-Pomianowska, R. Lollini, W. Pasut, A. Knotzer, P. Engelmann, A. Stafford, G. Reynders (2017). IEA EBC Annex 67 Energy Flexible Buildings. *Energy and Buildings* 155, 25-34. <https://doi.org/10.1016/j.enbuild.2017.08.044>.
- [3] Australian Energy Market Operator: AEMO (2022). Australian Integrated System Plan.
- [4] A. Satchwell, M. A. Piette, A. Khandekar, J. Granderson, N. M. Frick, R. Hledik, A. Faruqui, L. Lam, S. Ross, J. Cohen, K. Wang (2021). A national roadmap for grid-interactive efficient buildings. Lawrence Berkeley National Laboratory (LBNL), Berkeley, CA, USA.
- [5] International Energy Agency (2022). IEA Tracking report - Demand Response, September 2022.
- [6] K. Johansen, H. Johra (2022). A niche technique overlooked in the Danish district heating sector? Exploring socio-technical perspectives of short-term thermal energy storage for building energy flexibility. *Energy* 256, 124075. <https://doi.org/10.1016/j.energy.2022.124075>.
- [7] J. Le Dréau, P. Heiselberg (2016). Energy flexibility of residential buildings using short term heat storage in the thermal mass. *Energy* 111, 991-1002. <https://doi.org/10.1016/j.energy.2016.05.076>.
- [8] H. Johra, P. Heiselberg, J. Le Dréau (2019). Influence of envelope, structural thermal mass and indoor content on the building heating energy flexibility. *Energy and Buildings* 183, 325-339. <https://doi.org/10.1016/j.enbuild.2018.11.012>.
- [9] K.B. Wittchen, J. Kragh (2012). Danish building typologies: Participation in the TABULA project. SBI 2012:1. Danish Building Research Institute (SBI). [https://episcopus.eu/fileadmin/tabula/public/docs/scientific/DK\\_TABULA\\_ScientificReport\\_SBI.pdf](https://episcopus.eu/fileadmin/tabula/public/docs/scientific/DK_TABULA_ScientificReport_SBI.pdf).

## Belimo introduces the next generation of butterfly valves

Say goodbye to high energy consumption, inefficiency, sky-high costs, and discomfort caused by valves. We've revolutionised the industry by making these problems a thing of the past and enhanced our portfolio with exciting new products for valve sizes DN 100 to DN 150. Discover the true power of reliable and tight valves for HVAC systems and get the assurance that your critical application can operate seamlessly and with maximum efficiency.

Mark your calendars for the online launch event of our exciting new product, scheduled for March 7, 2024.

Register at [belimo.com](https://belimo.com)



**BELIMO**

# Real energy use and indoor air quality in a low energy residential building in Norway



**NATASA NORD**

Norwegian University of Science and Technology, Department of Energy and Process Engineering, Trondheim, Norway, natasa.nord@ntnu.no

The aim of this study was to document indoor air quality and real energy use in a low energy residential building in Norway. In addition, the aim was to reflect on good results, possibility for improvements together with reflection on some economic indices. This small, but well-documented example, may be relevant world-wide, because if the low energy concept may give relevant results in cold climate, then it may give even better results in other area with milder climate.

**Keywords:** real energy use, residential buildings, indoor air quality, low energy building

## Description of the low energy residential house

The observed row house, shown in **Figure 1**, was built in 2013 according to the low-energy building requirements at that time. The house is located in Trondheim, Norway. Due to privacy protection, photos of the house are not shown. The usable area of the house is 115 m<sup>2</sup> according to the building documentation. The observed house is occupied by three family members, two adults and one kid. The house is private owned, while all the houses in the neighborhood are organized in a small fellowship.



**Figure 1.** Row low energy house in Trondheim, Norway.

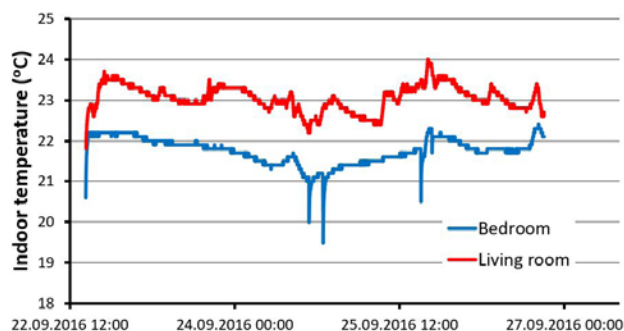
The entire area of the row houses is connected to the district heating system. Since the entire area is the low energy building area, the area is separated with a heat exchanger and supplied with the lower supply temperature than the main district heating in Trondheim. Each flat has its own substation for the district heating with its own heat energy meter. The flat substation has two heat exchangers, one for the heating purpose and one for the domestic hot tap water. The heating system in the house consists of radiators in the rooms and floor heating in the bathrooms.

The house has its own ventilation system with a separate air handling unit. The air handling unit consists of the supply and exhaust fan, heat recovery wheel, an electric heater, and supply and exhaust filters. The air flow rate through the air handling unit should satisfy the requirements explained in Introduction section.

## Indoor air quality in the low energy house

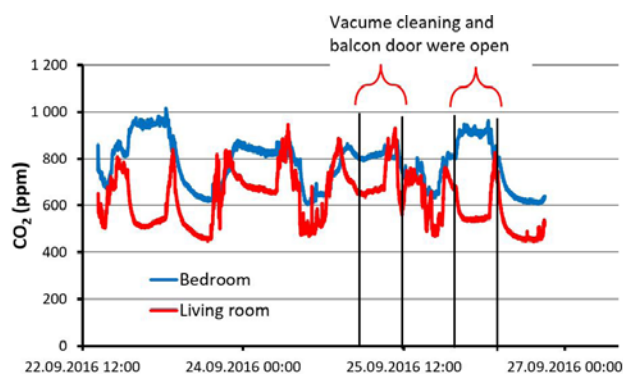
The installed air handling unit has neither monitoring of the indoor air temperature or CO<sub>2</sub> level for the control purpose. The fans are operating based on pre-defined settings. September 2016, the measurement of the indoor air temperature and CO<sub>2</sub> level in the above-mentioned rooms was performed. The results on the indoor air temperature and CO<sub>2</sub> level are shown in **Figure 2** and **Figure 3**. Please note that some possible cause for change in the CO<sub>2</sub> level are noted in **Figure 3**.

In **Figure 2**, it is evident that the indoor temperature was higher in the living room than in the bedroom. The reason for this was that intentionally the radiator was either on low or completely closed in the bedroom.



**Figure 2.** Indoor air temperature in two observed rooms.

In **Figure 3**, it may be noted that the CO<sub>2</sub> level was always higher in the bedroom on the ground floor. This happened due to issues in the air distribution and less air was delivered to the bedroom.



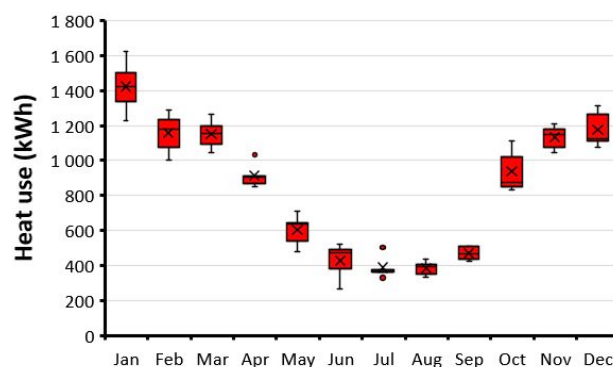
**Figure 3.** CO<sub>2</sub> level in two observed rooms.

### Energy and water use in the low energy house

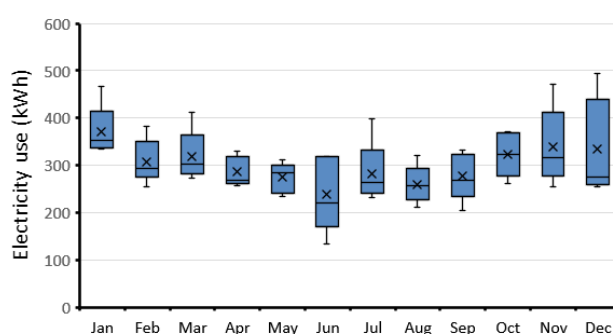
Before some key values on the energy and water use are given, it is important to note that the design outdoor temperature in Trondheim is  $-19^{\circ}\text{C}$ . In this study heating, electricity, and water use were documented from 2014 to 2018. In that period, the winter 2014 was cold and the minimum monthly temperature was  $-4.1^{\circ}\text{C}$ . Block plots for the monthly heat, electricity, and water use are given in **Figure 4**, **Figure 5**, and **Figure 6**, respectively.

In **Figure 4**, it is possible to notice seasonality, higher heat uses during the colder months from October until April, and lower use during the warmer months from May until September. In the observed period, the average total annual heat use was 10 162 kWh and the specific annual heat use was 93.38 kWh/m<sup>2</sup>. It is worth to note that for the observed house, a bigger variation in the heat use was noted in January, see **Figure 4**. The reason for this was that at the beginning of the house use, it was noted that the air from the ventilation was very cold. This happened because the supply outdoor air duct was fail connected and the cold air flown directly indoor without heat recovery. After the failure was corrected, the heating use in January decreased.

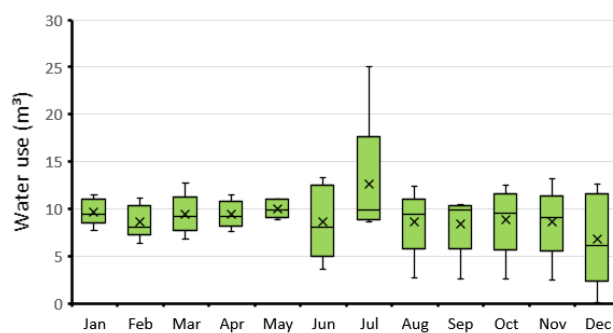
Finally, to identify factors influencing the heating use, the monthly heat use and the outdoor temperatures are compared as shown in **Figure 7**. The results in **Figure 7** show a still good relationship between the outdoor temperature and the monthly heat use. This means that the heat use is still related to the outdoor temperature regardless of good insulation.



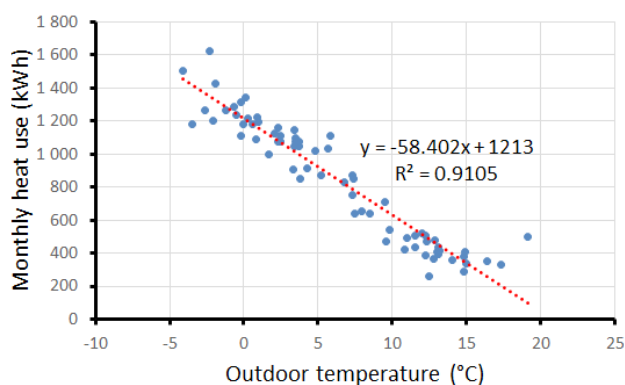
**Figure 4.** Monthly heat use.



**Figure 5.** Monthly electricity use.



**Figure 6.** Monthly water use.



**Figure 7.** Monthly heat use vs. outdoor temperature.

**Table 1.** Economic indices for the energy and water use.

	Heat	Electricity	Water	Municipality cost	Total
Annual cost	EUR 935	EUR 428	EUR 149	EUR 933	EUR 2 445
Indices per unit of energy or water	0.092 EUR/kWh	0.17 EUR/kWh	1.35 EUR/m <sup>3</sup>	-	-
Use and cost per m <sup>2</sup>	93 kWh/m <sup>2</sup>	43 kWh/m <sup>2</sup>	14.87 m <sup>3</sup> /m <sup>2</sup>	8.11 EUR/m <sup>2</sup>	19.97 EUR/m <sup>2</sup>

Regarding the electricity and heat use, it was difficult to note any seasonality. A bigger variation in the water use in July was due to an extremely warm summer 2014, when much water was used for watering the grass. The total average annual electricity use was 3 609.6 kWh, while the total average annual water use was 109.58 m<sup>3</sup>. A significant decrease in the electricity use was achieved by changing the light to LED light.

Finally, the total specific energy use, a sum of the total specific heat and electricity use, in the observed house was 125.2 kWh/m<sup>2</sup>. Compared to the Norwegian building code from 2010, the achieved results may be considered as suitable and satisfactory. In the observed house, the heat use share was about 70 % of the total energy use.

### Economic analysis

Finally, to evaluate economic benefits of the low energy house, cost data were analyzed. The economic indices in **Table 1** were calculated based on the invoices in two years. In Norway, the electricity bill consists of two parts: electricity use and the electricity grid fee. The electricity grid fee is divided into two parts, energy part and the constant part. However, the constant part in the grid fee part is still constant for all the customers regardless of their use or the instantaneous power extraction. This means that for the households presented in this paper with low electricity use, the grid

fee was consisting bigger part of the entire electricity bill. The district heating bill is consisting of only one, energy part. This means that the heat price per unit of heat is just multiplied with the monthly heat use. In addition to the energy bills, each household must pay different costs to the municipality. The municipality bill consists of different costs such as water use, water connections, wastewater, garbage, property tax, etc. Considering all these, all the costs are summarized in **Table 1**.

### Conclusions

This paper presented the five years of experience living in the low energy house. In general, the achieved results and living in the house are good. All the installations are performing well, and the contractor was helping during the entire guaranty period. However, some lessons for further projects that may be learnt are related to the installation of ventilation system and energy pricing models. Regarding the ventilation system, the conclusion was that it should be installed by a high competent company and a proper balancing should be done after the installation. Regarding the electricity pricing model, the conclusion is that the model with the constant grid fee is not attractive for the users connected to the district heating. In nowadays, when the focus in energy sector is on decreasing peaks in electricity use, the houses and users able to decrease their electricity load should be promoted. ■

# Digitalisation as a potential game changer to foster energy efficiency in the building stock



**MARKUS SCHAFFER**  
msch@build.aau.dk



**JUDITH FAUTH**  
judith.fauth@tuwien.ac.at



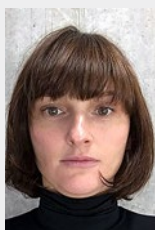
**HICHAM JOHRA**  
hj@build.aau.dk



**OLENA K. LARSEN**  
ok@build.aau.dk



**DANIEL LEIRIA**  
dle@build.aau.dk



**ANNA MARSZAL-  
POMIANOWSKA**  
ajm@build.aau.dk



**MICHAL POMIANOWSKI**  
mzp@build.aau.dk

This paper highlights innovative data treatment approaches for harnessing dynamic data in the building sector, focusing on commercial smart heat meters. Examples include closing the energy performance gap, two methods for disaggregating the total heat demand, and exploring fault detection in space heating systems across three apartments.

**Keywords:** digitalisation of building sector, smart metering, fault detection and diagnosis, disaggregation of total heat demand, Energy Performance Certificates

## Introduction

The digitalisation of the building sector progresses rapidly in all phases of the building's lifetime. With the Energy Performance Certificates (EPCs), which are valid for only 10 years, performance data are then collected multiple times during the operation phase. Since December 2018, European Union regulations have enforced remote readability and smart metering for energy carriers in all EU buildings [1]. Consequently, the estimates from 2020 indicate that 72% of electricity consumers had a smart electricity meter. By 2027, all buildings connected to an electricity grid or a district heating network must be equipped with such a smart meter. Similar requirements are made for smart gas meters. Furthermore, smart water meters also are

becoming increasingly common across the EU [2]. Thereby, dynamic energy and water usage data become available for a large share of the building stock. In addition, the digitalisation of households is ramping up with the deployment of IoT (Internet of Things). By 2028, it is estimated that approximately 40% of the EU dwellings will be equipped with IoT devices for energy and comfort management [3], thus gathering more data on indoor environment quality and energy performance.

This massive digitalisation could be the needed game changer to accelerate the decarbonisation of the building stock by offering dynamic assessment and optimization tailored to a single building and its occupants as well as the needs of local energy grids.

This article showcases the application of new data treatment frameworks and methods to leverage this massive influx of dynamic data. Since in 2022, more than 90% of European buildings were buildings solely equipped with energy meters lacking IoT-enabled sensors and devices [3], the starting point for all methods is the data available from smart meters, in particular heat and water. In the end, this work outlines the lessons learned and potential challenges to be faced by actors/stakeholders in the building sector working with digitalisation.

### Section 1: Data-driven building assessment framework

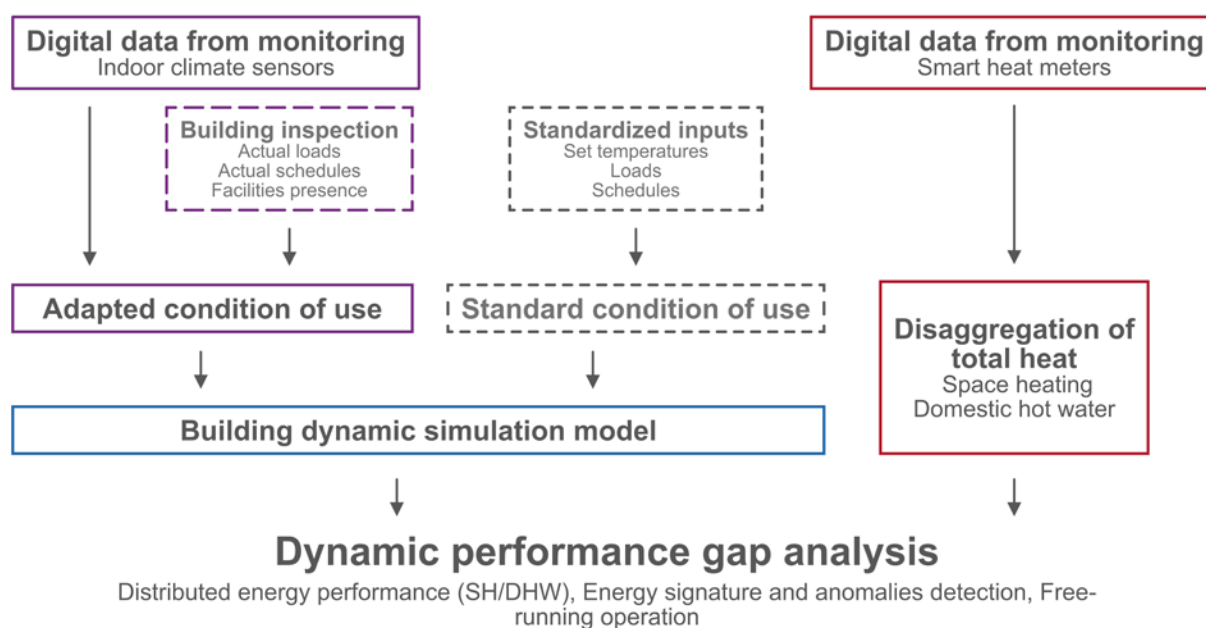
Initially, EPCs for buildings were introduced to offer transparent information regarding the energy performance of the building stock, serving as a vital asset in the data-driven implementation and evaluation of energy policies. Despite its widespread adoption, current EPC schemas exhibit several shortcomings [4]. These include a notable energy performance gap [4], a lack of consideration for comfort [4] and the free-running potential of buildings, and the absence of incentives for users to pursue energy efficiency [4].

Of significant concern, EPCs and tools used for labeling, in their static form, prove incompatible with dynamic data obtainable from monitoring solutions like indoor climate sensors or smart energy meters that can log data at high frequencies. This mismatch necessitates aggregating monitored data to the EPC calculation frequency, often on a monthly basis,

resulting in a substantial loss of information rather than its efficient utilisation.

In the EDYCE project [5], an effort has been made to advance toward future assessment of building performance by utilising digital data from indoor climate sensors to better inform the models and to improve the model predictive capabilities through a definition of ‘adapted conditions’. An energy performance gap is then calculated as a difference between simulated results and the monitored actual performance by smart heat meters (SHMs). Contrary to the EPC schema, the resolution of the results in E-DYCE can better match the time resolution from monitoring. The methodology is depicted in **Fig.1** and as presented, its main objective is to derive the energy performance gap, where the main advancements revolve around the following three activities: i) determination of adapted conditions of use, ii) disaggregation of space heating and domestic hot water production from the total heat recorded by SHMs (further elaborated in section 2 of this paper), iii) dynamic performance gap analysis.

The E-DYCE framework suggests replacing standardised inputs for modelling with adapted conditions of use, offering a more realistic representation of building operation in the model [6]. In particular, standard indoor temperatures are replaced by monitored ones, which are spatially aggregated and extrapolated to fit different modelling approaches for geometry simplifications. Performance gap analysis was carried out with weekly time steps, however, the E-DYCE framework allows for more frequent analysis, if relevant.



**Figure 1.** The methodology of data-driven building performance assessment in E-DYCE.

## Section 2: From total heat demand to space heating and domestic hot water

As shown above, current developments demonstrate that smart meter data harbours significant potential due to its high temporal resolution, commonly one hour or higher, and widespread adoption.

However, the usability of the data is compromised by the fact that smart meters in Denmark typically record the total heat energy used by a building or apartment, encompassing both space heating (SH) and domestic hot water (DHW) production — two distinct end uses. Separating energy usage for SH and DHW is imperative for frameworks investigating and seeking to address performance gaps, such as the E-DYCE approach. It is also crucial for district heating utilities looking to implement demand response strategies by modulating energy use for SH to reduce peak demand. In addition, it plays a fundamental role in identifying suitable energy efficiency measures, reasons for discomfort, and supporting a comprehensive analysis of the building's energy balance.

To meet the demand for knowledge about the separated energy use for each end use, a recent series of publications [7-10] has developed an approach to disaggregate the total energy recorded by SHMs into SH and DHW. The fundamental concept of this approach involves four steps:

1. Identify hours where only SH is used
2. Train a model on these hours

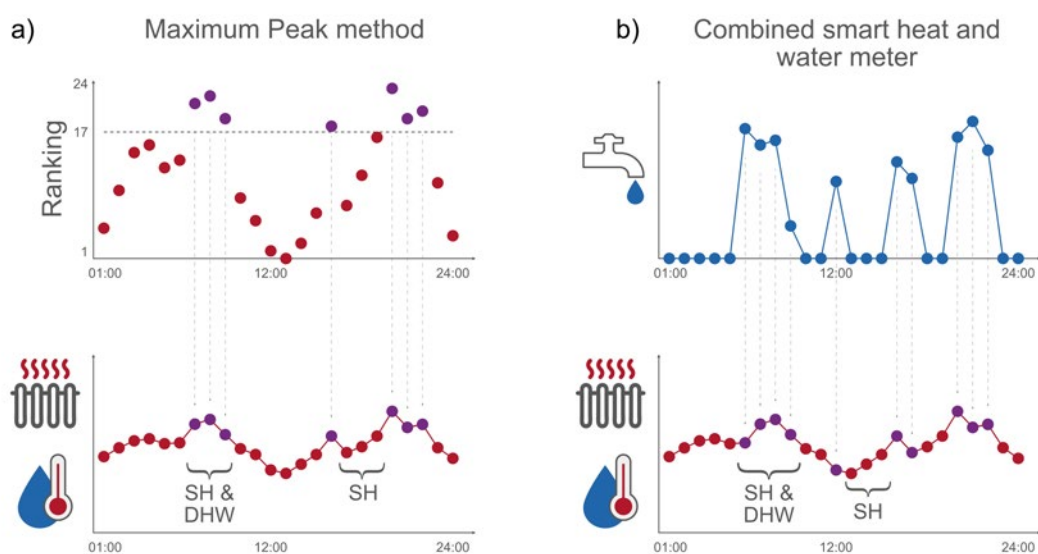
3. Use this model to predict SH for all hours where DHW may be used
4. Calculate DHW as the difference between the recorded total energy use and the predicted SH

Identifying hours with only SH use can be achieved using the “maximum peak” approach, assuming that hours involving both SH and DHW use are within the seven highest energy use recordings between 5 am and 11 pm (refer to **Fig.2a**). This approach has an accuracy of approximately 80% [8]. However, when hourly total potable water readings from smart water meters are available, this information can be used to identify hours with SH use only [10]. This prevents the misclassification of hours where DHW was used as hours with SH only (**Fig.2b**).

As for the model predicting SH, it has been demonstrated that a random forest model can accurately predict SH based solely on data from SHMs without the need for additional model fine-tuning [10].

## Section 3: Fault detection and diagnosis in space heating systems

Today, 50-60% of all building heating systems have faulty operation leading to higher volume flows and return temperatures and creating large barriers for buildings and district heating optimization. After the split of total heat demand to space heating and domestic hot water by using the above-described methods, the real-time insights provided by SHM



**Figure 2.** a) Identification of hours with SH and SH&DHW use based on the maximum peak approach. b) Identification of hours with SH and potential SH&DHW use based on data from smart water meters.

readings can be used for assessing the system performance and pinpointing faults that hinder efficiency.

**Fig.3** showcases the relationship between heat-carrier fluid volume flow and return temperature for three similar apartments. These apartments share the same SH systems and building characteristics, yet display varying SH performances. Apartment 1 maintains the most consistent and optimal performance throughout the year.

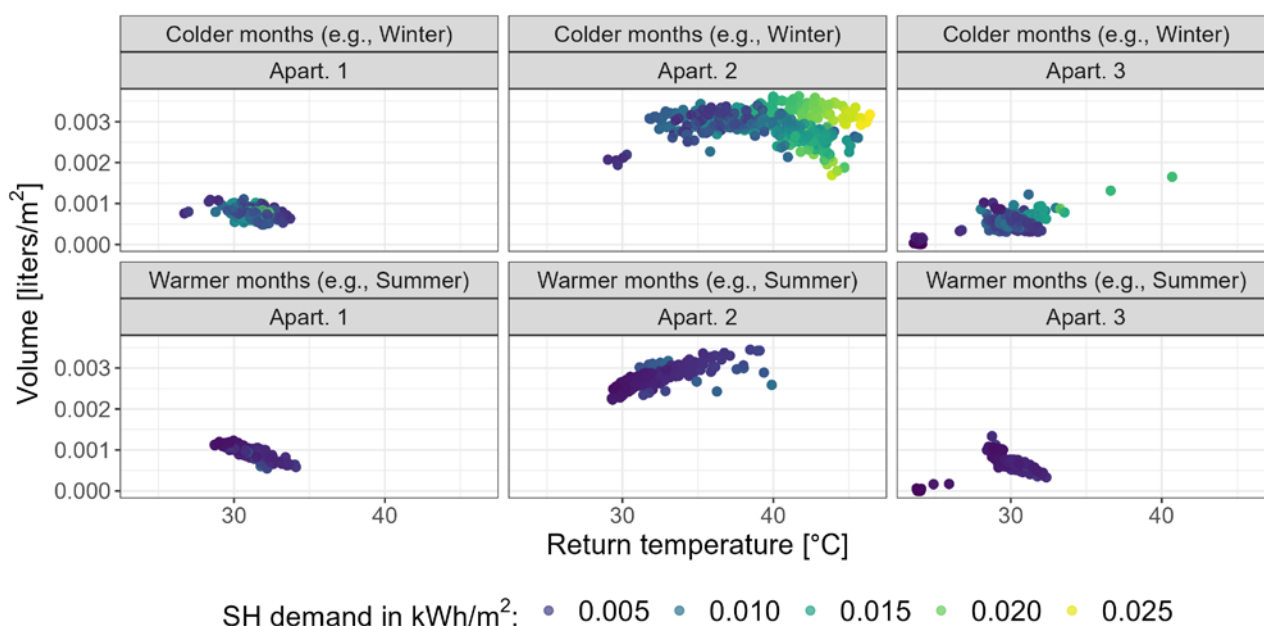
During warmer months, all apartments show a decrease in SH demand. However, Apartment 2 exhibits a significant shift in SH demand in colder months (greener data points denoting higher energy use). This variation signals potential inefficiencies, like an imbalance in heat distribution through the dwelling's radiators. Fixing the faults in Apartment 2 could result in energy demand and volume flow reductions, bringing its performance closer to the more efficient Apartments 1 and 3. Potential improvements in Apartment 2 can be estimated as a drop of around 19% in energy demand, a decrease of 75% in volume, alongside a 69% increase in the temperature difference between supply and return fluid during the colder months. Apartment 3's data also presents anomalies (periods without any heating use with minimum volume flow and low return temperatures), alongside occasional spikes in the return temperature.

This short example underlies that the SHM readings are not only destined for routine monitoring and billing but can also be employed for rapid detection and diagnosis of faulty heating systems that fall short of optimal operation over long periods and occasionally.

#### Section 4: Lessons learned and challenges

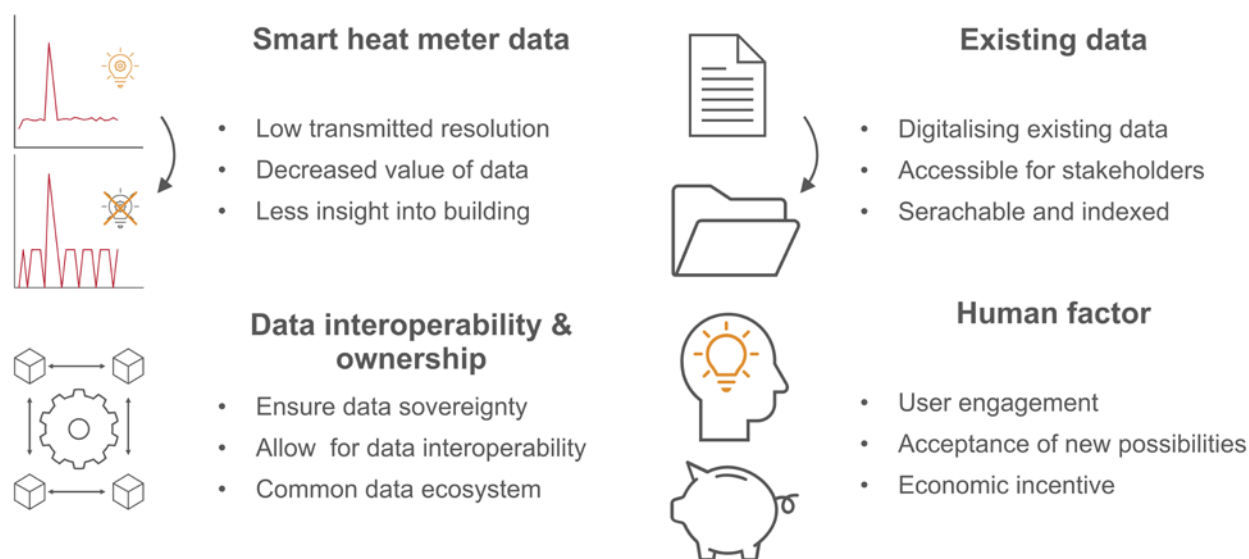
The ongoing process of digitalisation presents new opportunities to support the decarbonisation of the building stock. However, it comes with significant challenges. Some arise from the original intended use of data, such as smart heat meters being primarily designed for billing. Consequently, this data is often transmitted at a 1 kWh resolution, introducing uncertainty when estimating the energy demand at a fine granular level, especially for hourly estimates of individual apartments [11] (**Fig.4**).

Other common digitalization challenges include interoperability between diverse data sources and the importance of respecting data ownership, sovereignty and privacy. Within the building sector, research and policy efforts are addressing these issues (**Fig.4**). Initiatives like the Digital Building Logbook aim to establish a common data ecosystem within the EU for comprehensive data storage related to buildings [12].



**Figure 3.** Relation between energy, volume, and return temperature of three similar apartments with different SH performances.





**Figure 4.** Current and future challenges and opportunities regarding the digitalisation in the building sector.

Specifically concerning the existing building stock, a challenge emerges as significant information exists in paper-based form within relevant building authorities, often with limited or restricted access for stakeholders. Emerging technologies, such as text and image recognition, show great potential to increase the availability and usefulness of this information (**Fig.4**).

Ultimately, the engagement and awareness of building owners are pivotal for the success of digitalisation. Building tenants and owners recognising the challenges in achieving the decarbonisation of the building stock and accepting the new possibilities presented by data-driven methods (e.g., dynamic building control and demand response) are essential for building digitalisation to be successful. Finally, the economic incentive must be given, calling for new tariffs incorporating for example energy flexibility provided by a single building for a grid (**Fig.4**). ■

## References

- [1] Directive (EU) 2018/2002 amending Directive 2012/27/EU on energy efficiency <https://eur-lex.europa.eu/legal-content/EN/TXT/PDF/?uri=CELEX:32018L2002&from=EN>.
- [2] Berg Insight, 2023, Smart Water Metering in Europe and North America, 3rd Edition, <https://www.berginsight.com/smart-water-metering-in-europe-and-north-america>.
- [3] Smart Home - Europe. (n.d.). Retrieved November 20, 2023, from <https://www.statista.com/outlook/dmo/smart-home/europe>.
- [4] Li Y, Kubicki S, Guerriero A and Rezgui Y 2019 Review of building energy performance certification schemes towards future improvement Renew. Sustain. Energy Rev. 113 109244.
- [5] Energy flexible dynamic building certification (EDYCE) <https://edyce.eu/>.
- [6] Larsen, O. K., Pomianowski, M. Z., Chiesa, G., Belias, E., De Kerchove D'EXAERDE, T., Flourentzou, F., Fasano, F., & Grasso, P. (2023). E-DYCE - Dynamic approach to the dynamic energy certification of buildings. *Journal of Physics*, 2600(3), 032015. <https://doi.org/10.1088/1742-6596/2600/3/032015>
- [7] Leiria, D., Johra, H., Belias, E., Quaggiotto, D., Zarrella, A., Marszal-Pomianowska, A., & Pomianowski, M. (2022). Validation of a new method to estimate energy use for space heating and hot water production from low-resolution heat meter data. *E3S Web of Conferences*, 362, 10001. <https://doi.org/10.1051/e3sconf/202236210001>.
- [8] Leiria, D., Johra, H., Marszal-Pomianowska, A., & Pomianowski, M. Z. (2023). A methodology to estimate space heating and domestic hot water energy demand profile in residential buildings from low-resolution heat meter data. *Energy*, 263(PB), 125705. <https://doi.org/10.1016/j.energy.2022.125705>.
- [9] Leiria, D., Schaffer, M., Johra, H., Marszal-Pomianowska, A., & Pomianowski, M. Z. (2023). Estimating residential space heating and domestic hot water from truncated smart heat data. *Journal of Physics: Conference Series*, 2600(2), 022017. <https://doi.org/10.1088/1742-6596/2600/2/022017>.
- [10] Schaffer, M., Widén, J., Vera-Valdés, J. E., & Marszal-Pomianowska, A. (Submitted). Disaggregation of Total Energy Use into Space Heating and Domestic Hot Water: A city-scale suited approach. *Energy*.
- [11] Schaffer, M., Leiria, D., Vera-Valdés, J. E., & Marszal-Pomianowska, A. (2023). Increasing the accuracy of low-resolution commercial smart heat meter data and analysing its error. 2023 European Conference on Computing in Construction 40th International CIB W78 Conference.
- [12] European Commission, Executive Agency for Small and Medium-sized Enterprises, Volt, J., Toth, Z., Glicker, J. et al., Definition of the digital building logbook – Report 1 of the study on the development of a European Union framework for buildings' digital logbook, Publications Office, 2020, <https://data.europa.eu/doi/10.2826/480977>.

# Field investigation of indoor air quality in one Norwegian apartment building with burning candles



**AZIMIL ALAM**

Student – Norwegian University of Science and Technology



**JULES NACINIVI**

Student – Norwegian University of Science and Technology



**KASPER OPPI**

Student – Norwegian University of Science and Technology



**THIBAUT LOSTE**

Student – Norwegian University of Science and Technology



**GUANGYU CAO**

Dr. (Sc). Professor – Department of Energy and Process Engineering, Norwegian University of Science and Technology

Corresponding author email: [Guangyu.cao@ntnu.no](mailto:Guangyu.cao@ntnu.no)

This research aimed to quantify the effects of burning candles on Indoor Air Quality (IAQ) in Norwegian apartment building, and explored the relationship in between, since impacts of burning candles produces different serious contaminants spread along room. Multiple scenarios were investigated, and free-standing sensors were employed to measure various IAQ parameters. The findings revealed a significant increase of indoor pollutants when candles were burned indoors. Result shows application of air ventilation showed a slight improvement in IAQ level, although burning candles remained detrimental to indoor air quality. Turned out this work that refraining from lighting candles is the most effective way to maintain healthy IAQ in indoor environments. Air ventilations offered a modest improvement, but the most effective solution remains avoiding candle burning indoors. Further investigation may be needed with larger scales and quantity of experiments.

**Keywords:** Indoor Air Quality, indoor pollutant, burning candles, Norwegian apartment, ventilation strategy

## Introduction

Indoor air quality (IAQ) is a crucial aspect of modern living, significantly influencing the health, comfort, and overall well-being of individuals. Among the numerous factors affecting IAQ, the presence of candle lights in indoor environments has become a topic of interest in recent years, especially in regions where

candles are widely used, such as in some Scandinavian countries, including Norway for various purposes for creating a pleasant household indoor climate [1,2]. Candles, can release particulate matter and other pollutants into the indoor air, potentially compromising the IAQ. When a candle burns, it undergoes a chemical reaction of hydrocarbon-based molecules as a fuel with

oxygen in the air, producing contaminants, heat, light, water vapour, and carbon dioxide concentration (CO<sub>2</sub>) [3]. The calculated emission rate constants (ER) of the investigated gaseous compounds ranged between 92 and 4,910 µg/h[4]. Both acute and chronic exposures to indoor pollutants such as particle matters and organic compounds could induce adverse health effects such as damage to the nervous system, immune and reproductive diseases, respiratory system dysfunction, developmental problems, and cancers [5]. Numerous studies have been carried out to characterise the indoor emission and to quantify the emission induced by incense and candle combustion [6,7,8]. Addressing these concerns requires a comprehensive field investigation that considers multiple variables and scenarios.

Norwegian government issues a national guideline and regulation which also determines the required limits regarding the concentration of pollutants to achieve good indoor air quality of residential building, including particulate matters (PM), asbestos, formaldehyde, benzene, CO<sub>2</sub>, CO, and ozone. The indoor CO<sub>2</sub> concentration affect dissatisfaction of occupants at each certain level[9]. Indoor contaminant in Norway has maximum limits (requires daily concentration PM<sub>2.5</sub> < 15µg/m<sup>3</sup> and CO<sub>2</sub> level <1,000 ppm as recommendation)[10], besides, ventilation amount in Norway has its local standard which are 26m<sup>3</sup>/h for each person and extra 2.6 m<sup>3</sup>/h per square-meter of room area[11].

The primary objective of this research is to investigate the effect of burning candles on indoor air quality in a Norwegian apartment building. The study aims to understand how the ventilation strategy will affect indoor air quality in residential building with burning candles.

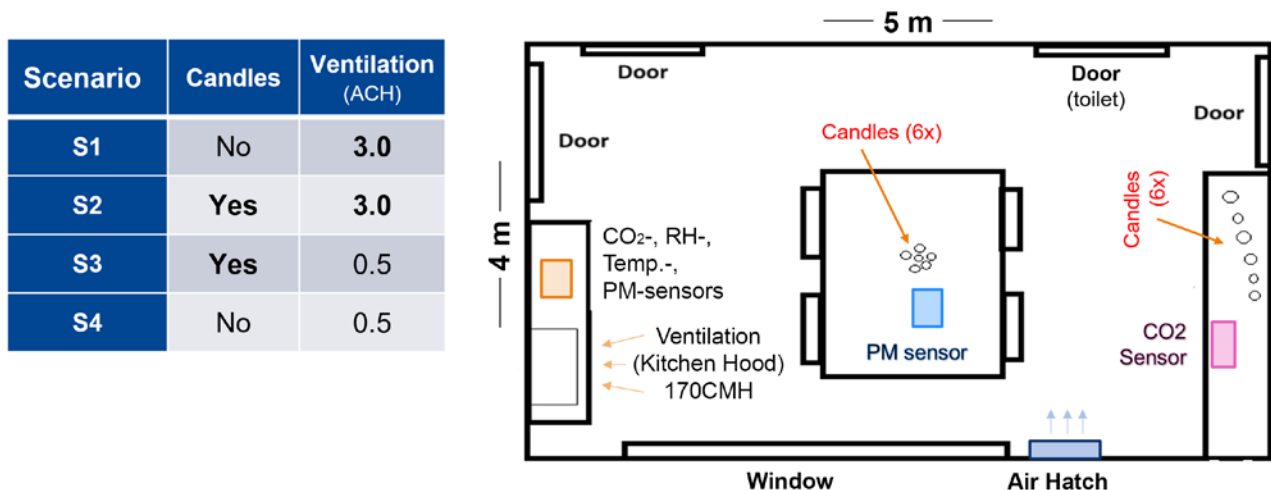
## Method

### Measurement setup

An apartment building named *Moholt-studentby* in Trondheim City, was used for the field investigation. The apartment has four bedrooms, a bathroom, and a kitchen-dining room with a kitchen hood as an extract ventilation function (170m<sup>3</sup>/h equal with 3.0 ACH) in this study. In addition, there is a toilet next to the room we had investigated, it also has continuous exhaust ventilation centrally from the building on the rooftop. Experimental measurements with a few scenarios were conducted in the dining room at the end of October 2023. Free-standing sensors are applied during the experiment (CO<sub>2</sub>, Relative Humidity, Temperature and PM<sub>2.5</sub>). Air hatch as air-open hole is located on the top level of the room, it can easily be closed or opened manually. Likewise, the air in the room has been changed between each scenario in order to reset the normal conditions of CO<sub>2</sub> and PM concentration at the beginning of each measurement. In the room there are four volunteer occupants with a light activity around the dinner table. Twelve candles were used in each scenario, dispatched between the dining table and the work station. Room layout scheme is shown in **Figure 1**.

### Scenario Design

Few scenarios were developed and conducted in this work, in order to be able to compare the different scenarios, the four scenarios have the same initial state by opening the windows for twenty minutes before each measurement. The first two scenarios compare the influence of candles on indoor air quality while the ventilation is on, whereas the two last scenarios compare this influence while the ventilation is off. Four scenarios are shown in **Figure 1**.



**Figure 1.** Design of scenarios, and room layout during experiments.

CONTAM as specialist in simulation program was used in this study to simulate indoor air quality. Some boundary conditions such as: room volume, occupants' number, duration, written capacity of mechanical ventilation (kitchen hood), opening holes are mentioned in simulation. By using simulation approaches, we will find out the emission rate and assume it is constant in each case.

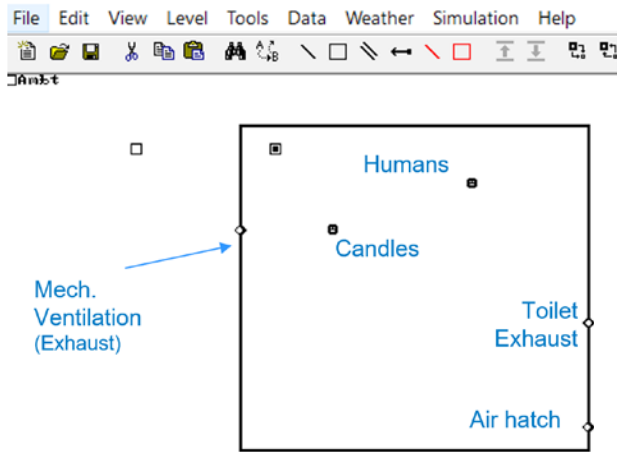


Figure 2. Configuration in CONTAM® Simulation.

## Result & Discussions

Measured room air temperature, which increases in all scenarios due to external and internal heat gain in the room as shown in **Figure 3**. The heat gains due to the human body metabolism and indoor electronic was considered stable. While the extra internal heat gain may be caused by the candle burning. For all the scenarios the temperature is increasing due to these heat gains in the room. Noticing that for scenarios with the same state of ventilation, the one with candles will be warmer than the one without. In practice, S2 and S3 comparison between S2 and S3 shows us how mechanical ventilation application could extract the heat significantly.

**Figure 4** show the CO<sub>2</sub> concentration and the particle concentration during each experiment. Not only human body metabolism, but candle lights also produce CO<sub>2</sub> contaminants into the room. There are similarities between the simulation with ventilation and without. While the CO<sub>2</sub> concentration increases a bit in the beginning it does reach a steady state when the ventilation is on, but when it is off the concentration is steadily increasing. The difference between the scenarios with ventilation is that the steady-state concentration of CO<sub>2</sub> is higher with the candles. Without the candles the concentration is around 1,000 ppm, while with the candles the

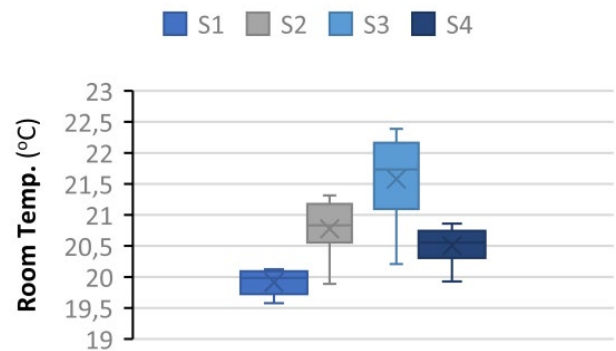
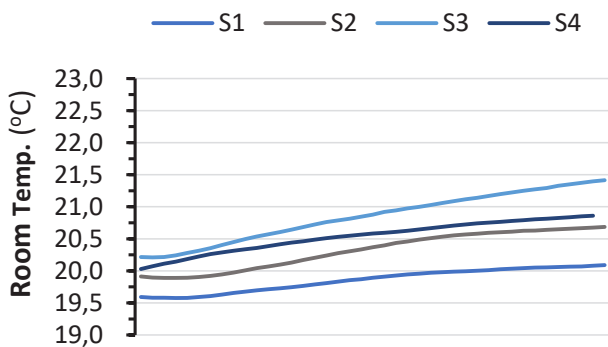


Figure 3. Temperature level: (left) in timestep (right) in descriptive statistic.

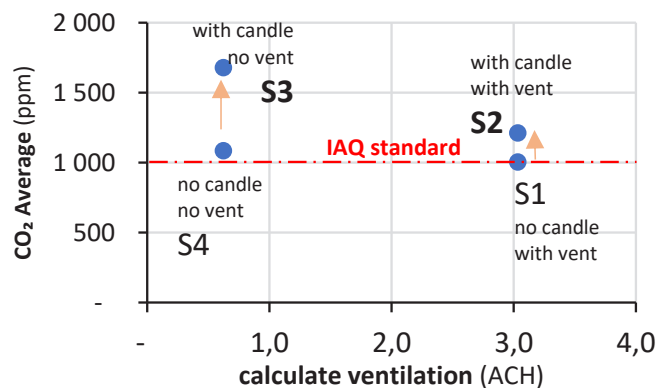
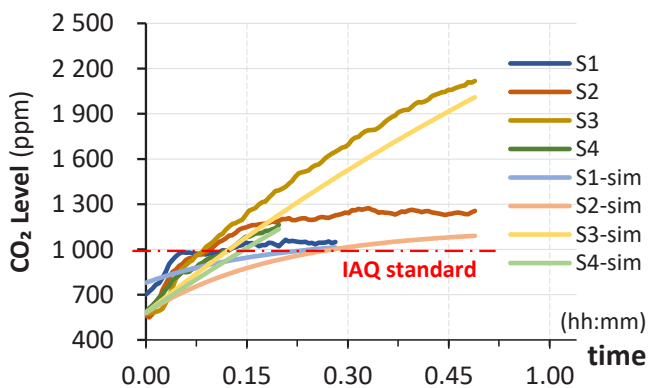


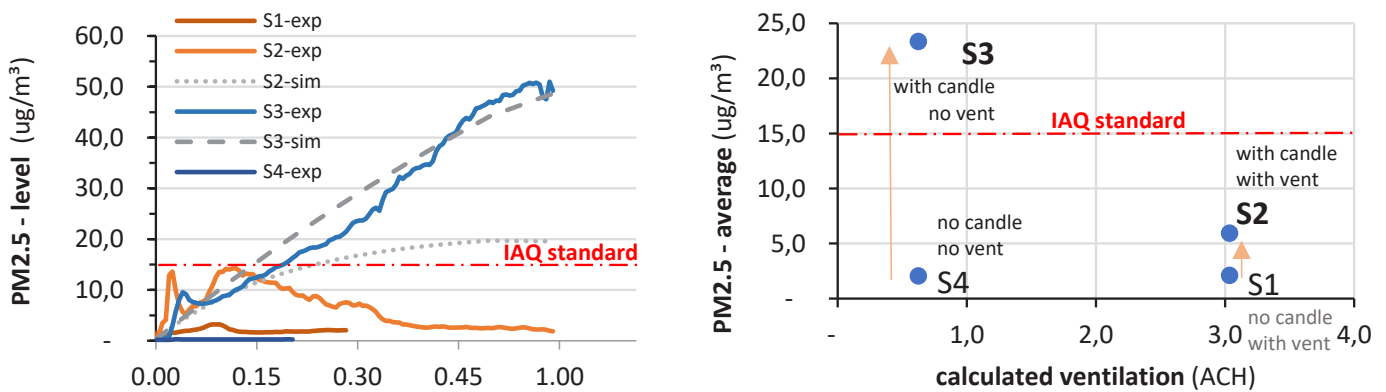
Figure 4. CO<sub>2</sub> concentration level: (up) in timestep (down) mean value vs. ventilation change each scenario.

concentration is around 1,200 ppm (S2) and even the ventilation of kitchen hood is off, the CO<sub>2</sub> increased but the scenario with the candles the CO<sub>2</sub> achieved significantly around 1,700 ppm-average (S3). It is therefore possible to say that burning candles can increase CO<sub>2</sub> concentration in a room much higher, where this is also confirmed by another study[12]. Also, measurement from experiments validated theoretical approach as shown in simulations and they performed similar results.

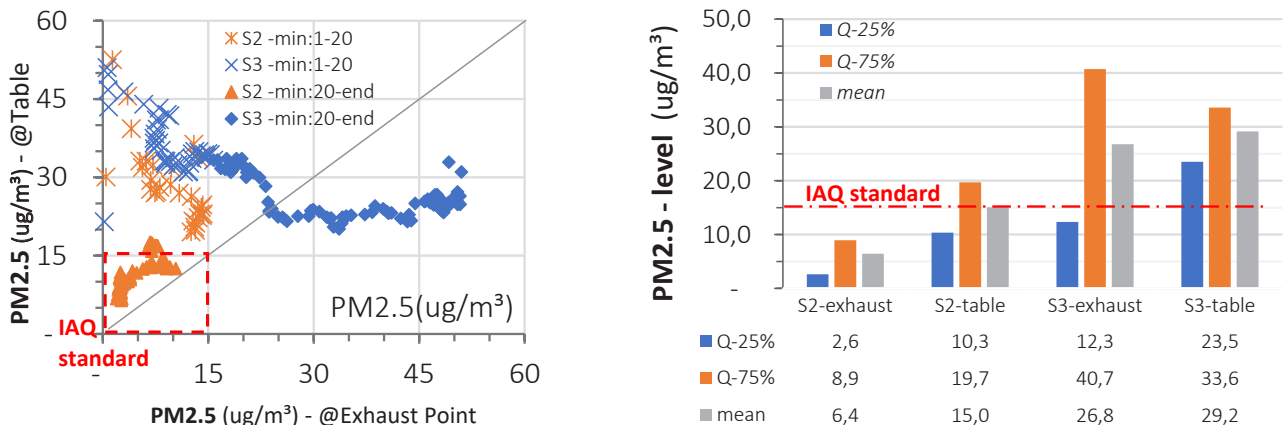
As candles produce soot and pollutants that can be spreading freely into the air through its thermal plume, the difference of PM concentration was analysed between scenarios. Results show That the particle concentration behaves a bit different from the CO<sub>2</sub> Concentration. In fact, the measured CO<sub>2</sub> concentration behaves like the simulated scenarios, the PM concentration in S2 does not behave as the simulated scenario. The simulated scenario assumes a uniform distribution of particles, while this is not the case when the ventilation is on. For S3 the PM concentration behaves somewhat the same as the simulated. The scenarios without mechanical ventilation of kitchen hood (S3) show how much particles the candles emitted extremely. The peak value of

scenario-3 was almost 50 µg/m<sup>3</sup> and is still increasing, while candles ran along with mechanical ventilation from kitchen hood together (S2) took around 10-15 µg/m<sup>3</sup> below than applied local standard, as shown in **Figure 5**.

To indicate particle spread in room, comparison the concentration of particles on the table and at the exhaust point (mechanical ventilation / kitchen hood) has shown in **Figure 6**. This concentration was measured with a sensor on the table and with a sensor at the exhaust. Two different sections can be identified, during the first twenty minutes, the concentration of particles is very high on the table and quite low at the exhaust, that means that burning candles will directly harm the occupants. Then, after twenty minutes, the concentration on the table decreases and, if there is no ventilation system, the concentration at the exhaust could be higher, the particles spread around the room. **Figure 6 (right)** shows that the concentration on the table is on average higher than at the exhaust point. Therefore, even if there is a ventilation system, the occupants will be exposed to a higher concentration of particles than usual since the Particulate Matter (PM2.5) concentration at the table constantly exceeds that at the exhaust point within the indicated time range.



**Figure 5.** PM concentration level: (left) in timestep and; (right) mean value vs. ventilation change each scenario.



**Figure 6.** Comparison of PM2.5 concentration in different scenarios: (left) on table vs. (right) exhaust point.

This convergence suggests a change in the dynamics of pollutant dispersion over time, indicating the need for careful evaluation and potentially tailored interventions to protect occupants from increased particulate matter levels.

## Conclusions

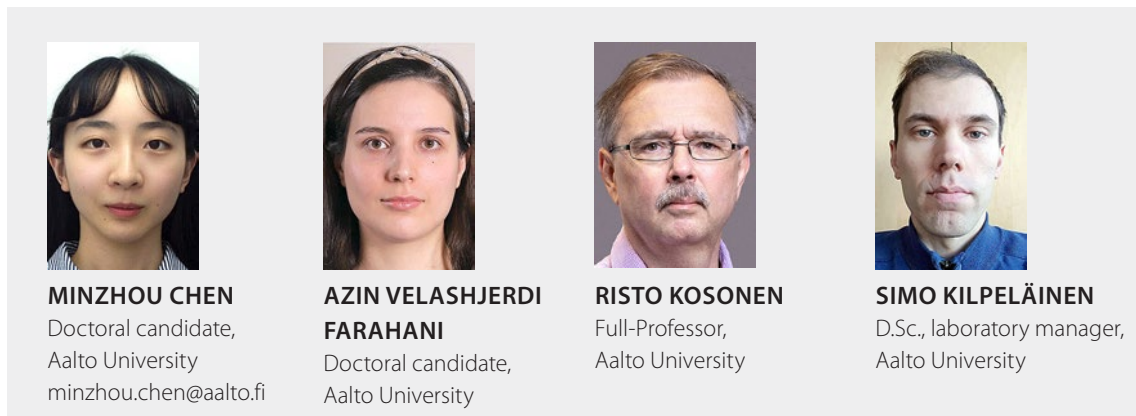
This study underscores the adverse impact of burning candles on indoor air quality in Norwegian apartment buildings. It is proven that burning candles increases indoor pollutants significantly if only supplying low amount of outdoor air. The increased contaminant concentration by burning candles may increase the risk of human exposure. Greater ventilation rate has

been proven to be able to reduce indoor pollution concentrations to an acceptable level. While mechanical ventilation offered a significant improvement, the most effective solution remains avoiding candle burning or reduce the number of candles that are used at the same time indoors, regardless any kind of applied ventilation it has. If candles are used, placing candles close to extract or exhaust point may reduce the transmission of pollutants produced by the burning candles to the rest of the room and even to the occupants, thus reduce the risk of human exposure. Further comprehensive and larger scale of experiments may be performed to explore diverse factors that affect the spreading of pollutants from burning candles. ■

## References

- [1] Wyss, A. B., Jones, A. C., Bølling, A. K., Kissling, G. E., Chartier, R., Dahlman, H. J., . & London, S. J. (2016). Particulate matter 2.5 exposure and self-reported use of wood stoves and other indoor combustion sources in urban nonsmoking homes in Norway. *PloS one*, 11(11), e0166440.
- [2] Stuhlmiller, C. M. (1998). Understanding seasonal affective disorder and experiences in Northern Norway. *Image: The Journal of Nursing Scholarship*, 30(2), 151-156.
- [3] Raju, M. P., and J. S. T'ien. "Modelling of candle burning with a self-trimmed wick." *Combustion Theory and Modelling* 12.2 (2008): 367-388.
- [4] Derudi, M., Gelosa, S., Sliepcevich, A., Cattaneo, A., Rota, R., Cavallo, D., & Nano, G. (2012). Emissions of air pollutants from scented candles burning in a test chamber. *Atmospheric Environment*, 55, 257-262.
- [5] WHO - World Health Organization (2005) Air quality guidelines – global update 2005. WHO Regional Publications, editor. European Series.
- [6] Glytsos T, Ondracek J, Dzumbova L, Kopanakis I, Lazaridis M (2010) Characterization of particulate matter concentrations during controlled indoor activities. *Atmos Environ* 44:1539–1549.
- [7] Pagels J, Wierzbicka A, Nilsson E, Isaxon C, Dahl A, Gudmundsson A et al (2009) Chemical composition and mass emission factors of candle smoke particles. *J Aerosol Sci* 40:193–208.
- [8] Maupetit F, Squinazi F (2009) Characterization of benzene and formaldehyde emissions from burning incense and scented candles indoors: development of exposure scenarios and recommendations for use. *Environ Risque Santé* 8:109–118.
- [9] Jokl, M. V. (2000). Evaluation of indoor air quality using the decibel concept based on carbon dioxide and TVOC. *Building and Environment*, 35(8), 677-697.
- [10] Miljø-Direktoratet (2020). Grenseverdier for svevestøv, Forslag til reviderte grenseverdier for PM10 og PM2,5 <https://www.miljodirektoratet.no/globalassets/publikasjoner/m1669/m1669.pdf>.
- [11] Direktoratet For Byggkvalitet (2017). Ventilasjon i byggverk for publikum og arbeidsbygning, Byggteknisk forskrift (TEK17) med veiledning § 13-3. <https://www.dibk.no/regelverk/byggteknisk-forskrift-tek17/13/i/13-3>.
- [12] Kapalo, P., Kováč, M., Nagy, R., & Baka, Z. (2022, September). Indoor air quality assessment in the apartment–case study. *In IOP Conference Series: Materials Science and Engineering* (Vol. 1252, No. 1, p. 012061). IOP Publishing.

# Investigation of whether elderly people can benefit from local cooling devices in warm environments



The benefits of local cooling devices are being cheap, energy-efficient, user-friendly, portable, and personalized. The study conducted confirmed the positive effects of three local cooling devices, including normal table fan, evaporative cooling devices, and air-cooled jacket, on the physiology and psychology of the elderly. The three local cooling devices depicted to be capability to reduce thermal discomfort for the elderly. Using devices in a 28°C/60% and 29°C/40% environment can return the elderly's thermal sensation to a neutral state, making them feel comfortable.

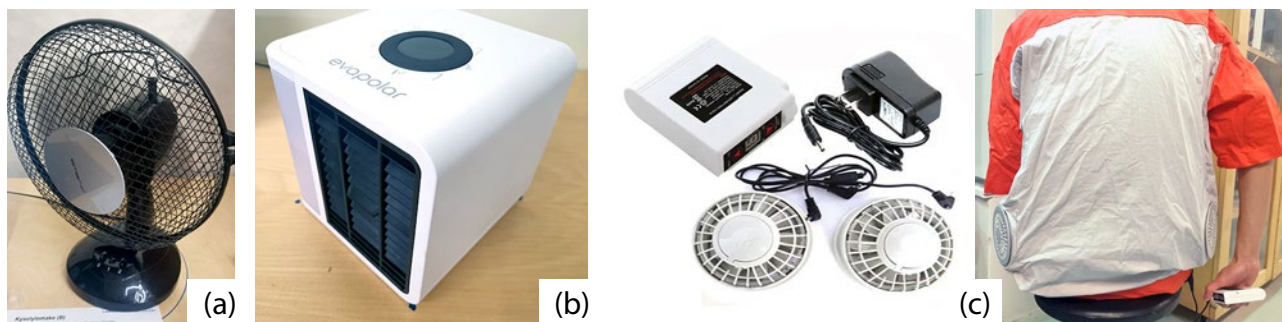
**Keywords:** Thermal comfort; elderly people; local cooling devices; warm environment

## Convective local cooling devices

Global warming exacerbates the difficulties faced by aging societies. Increased cardiovascular strain caused by heat stress is an important health concern during heat waves. Compared with young adults, older adults face more difficulties, such as reduced mobility and perception, as well as fuel poverty.

This study selected three convective local cooling devices that are available on the market: the table fan (**Figure 1(a)**), evaporative cooling device

(**Figure 1(b)**), and air-cooled jacket (**Figure 1(c)**). The table fan was 230 mm in diameter with an electric power range of 0–25 W. The evaporative cooling device was 180 mm × 180 mm × 182 mm. It had a medium that was humidified via capillary action using water from a small side tank (1000 mL) and a small fan with an electric power range of 0–10 W. The air-cooled jacket, designed to be worn over clothing, consisted of a spacer vest liner with an impermeable outer layer, two 97-mm wide fans placed symmetrically on the lower back, an internal pocket for a rechargeable battery,



**Figure 1.** Convective local cooling devices: (a) table fan, (b) evaporative cooling device, and (c) air-cooled jacket.

and weighed 0.7 kg. The total electric power range is 0–20 W. The table fan and air-cooled jacket drew room air, and the evaporative cooling device produced cooler (approximately 2°C) but more humid air.

### Climate chamber experiments

A previous study [1] estimated that in Finland in 2050, rooms without cooling systems will experience more hours above 32°C, whereas rooms with ventilation systems will experience more hours above 27°C. Thus, a total of five conditions, using the air temperature ( $T_a$ ) and relative humidity (RH) of typical summertime and heat wave periods in Finland [2], were selected for experiments:  $T_a = 26^\circ\text{C}$ , RH = 40%; 28°C, 60%; 29°C, 40%; 32°C, 50%; and 33°C, 40%. To control the environmental parameters to achieve the setting values, this experiment was conducted in a climate chamber, as shown in **Figure 2**. The climate chamber environment was controlled by a diffuse-ceiling ventilation system and humidifiers. The environmental parameters were detected by six TinyTag 2 plus data loggers.

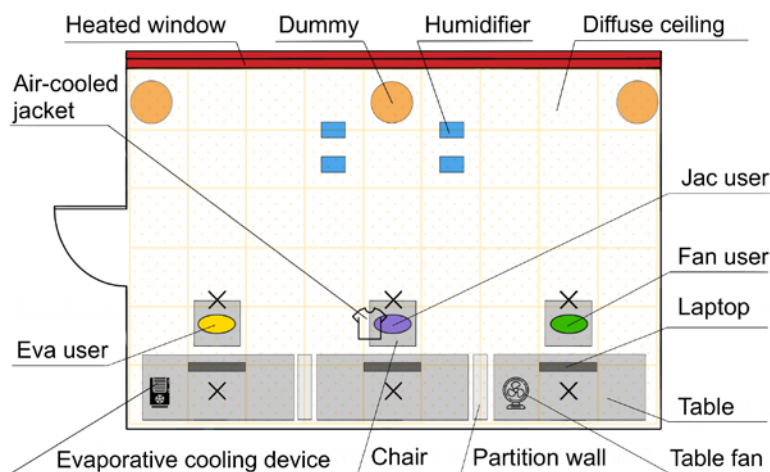
The Aalto University Research Ethics Committee authorized and supported this study (D/793/03.04/2021, approved on September 23, 2021). We recruited

26 healthy Finnish elderly people to participate in the experiment. The experimental process is shown in **Table 1**. During the experiment, the participants' physiological and psychological parameters were collected. By filling questionnaires, we obtained the thermal sensation and thermal comfort state (psychological parameters) of the elderly. The questionnaire including thermal sensation vote (-3 to +3: cold to hot) and thermal comfort vote (-3 to +3: very cold uncomfortable to very hot uncomfortable). The skin temperature and core temperature (physiological parameters) of the elderly were obtained through iButton sensors and an ear temperature gun, as shown in **Figure 3**.

### Performance of local cooling devices

The thermal sensation vote (TSV) and thermal comfort vote (TCV) collected at the end of the rest phase and three time points in the local cooling phase are shown in **Figure 4**.

The skin temperature measured at the end of the rest phase and in the entire local cooling phase is shown in **Figure 5(a)**. The core temperature measured at the end of the rest phase and three time points in the local cooling phase are shown in **Figure 5(b)**. ▶



**Figure 2.** Climate chamber test layout. (Fan = table fan; Eva = evaporative cooling device; Jac = air-cooled jacket).

**Table 1.** Schedule of the experiment.

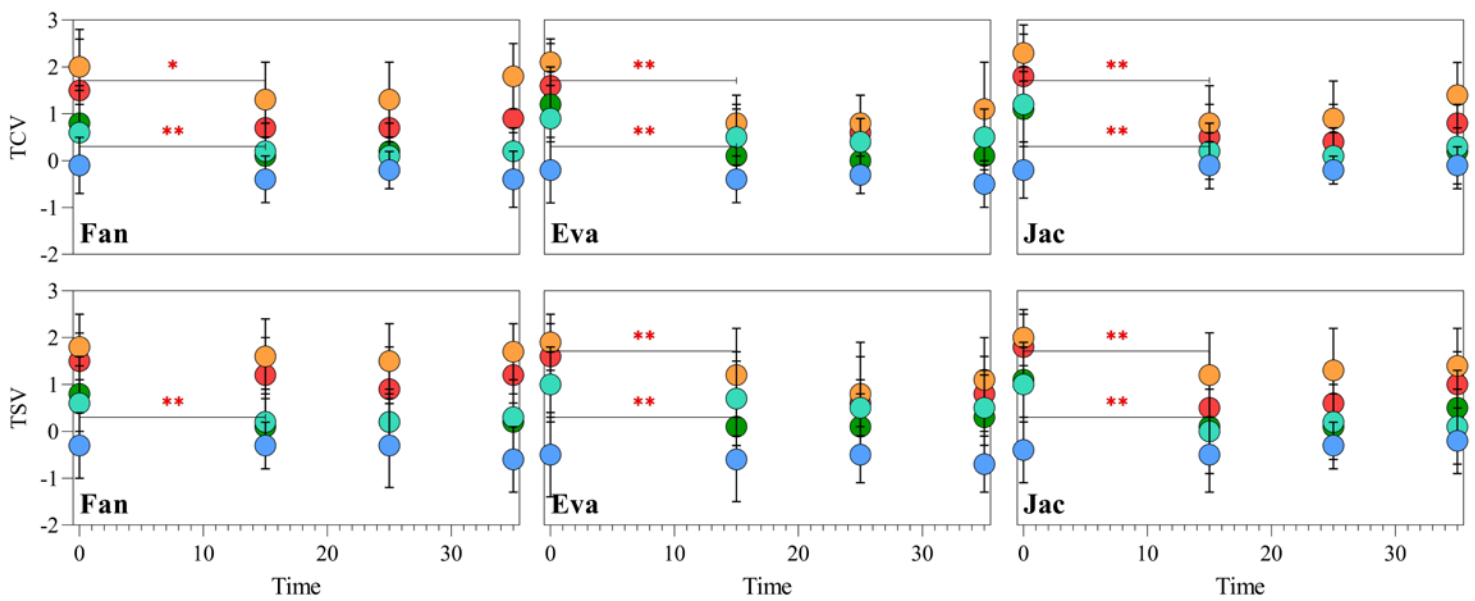
Step	Phase	Time	Participant activities	Data collection
1	Preparation	25 min	Change clothe and attach sensors	(Skin temperature is measured continuously with a 10s interval after attaching sensors)
2	Rest	35 min	Remain sedentary (Unable to use device)	Core temperature and questionnaire at the 35th minute
3	Local cooling	15 min	Free use of local cooling device for 40 minutes	Core temperature and questionnaire at the 15th minute
		10 min		Core temperature and questionnaire at the 10th minute
		10 min		Core temperature and questionnaire at the 10th minute

\*Cycle 2 and 3 until each participant has used all three local cooling devices.

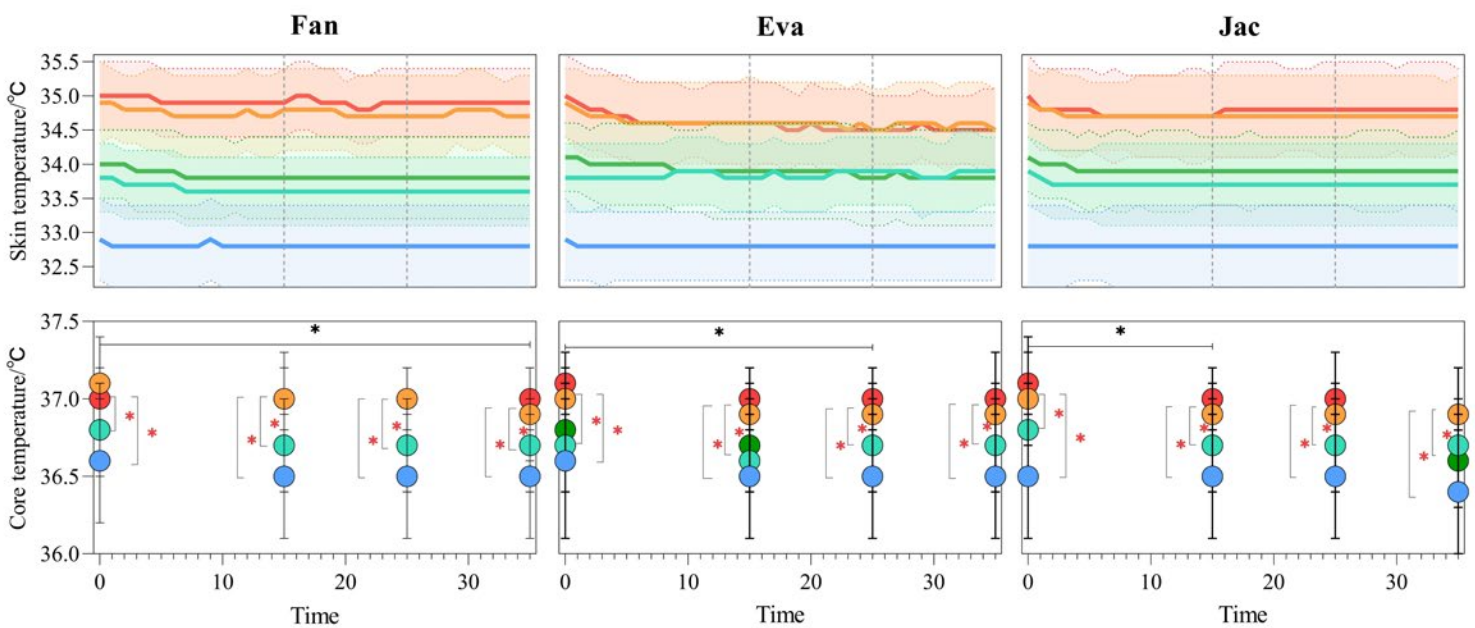




**Figure 3.** Measurements of skin temperature and core temperature.



**Figure 4.** Elderly people's psychological parameters: (a) TCV and (b) TSV.



**Figure 5.** Elderly people's physiological parameters: (a) skin temperature and (b) core temperature.

- A statistically significant difference ( $P < 0.05$ ) was observed in the physiological and psychological parameters of elderly people before and after using local cooling devices. Compared with the thermal perception vote (TSV and TCV) in the rest phase, the first voting (at the 15th minute) in the local cooling phase decreased significantly, which means participants felt cooler and more comfortable. Using devices in a slightly warm (28°C, 60%; 29°C, 40%) environment can return the elderly's thermal sensation to a neutral state, making them feel comfortable. However, this effect cannot be achieved when using devices in a warm environment (32°C, 50%; 33°C, 40%).

During the local cooling phase, the skin temperature of the elderly dropped rapidly by about 0.5°C in 10 minutes before remaining stable. The core temperature decreased slower than the skin temperature, and decreased about 0.1°C. Among all local cooling devices, the table fan exhibited comparatively lower efficacy in alleviating thermal discomfort, particularly in warmer environments; and the evaporative cooling device performed the best, especially in lower humidity environments.

### Practical applications

In contrast with typical cooling methods such as air conditioning cooling and radiant cooling systems, the convective local cooling device shows a distinct advantage in rapidly reducing skin temperature and thermal sensation. They are even able to produce a cooler sensation than what skin temperature would predict. When the environment is around 29°C, convective local cooling devices can effectively reduce thermal stress on the human body, and ensure the comfort and health of the elderly.

Although the psychological parameters decreased to levels below what was predicted based on the physiological parameters, this may not be beneficial in a warmer environment. Due to the high skin and core temperatures in the environment around 33°C, the thermal stress is not effectively removed, but only the subjective feeling is alleviated. Thus, elderly people are not suggested to rely only on convective local cooling devices under these conditions. The addition of colder air is necessary to lower skin and core temperatures and promptly reduce thermal stress in the human body. A convective local cooling device may be employed as a supplementary facility during the start-up phase of use for air conditioning and radiation cooling systems.

The three local cooling devices examined in this research exhibit a capability to reduce thermal discomfort for the elderly. Furthermore, their electrical power of around 20 W ensures that these devices will not burden the energy expenses of the elderly. These portable, low-power devices, which are commonly powered by outlets or portable power sources, can offer thermal comfort to individuals at anytime and anywhere. The thermal comfort they offer may be disregarded by current flexibility strategies for grid control [3], which classify them as minor miscellaneous plug loads. Potential consideration for future research on flexibility strategies could be given to this aspect. ■

### Acknowledgments

This study is part of the following projects: HEATCLIM (Heat and health in the changing climate, Grant Numbers. 329306, 329307) funded by the Academy of Finland within the CLIHE (Climate change and health) program.

### Reference

- [1] Velashjerdi Farahani, Azin, et al. "Overheating risk and energy demand of Nordic old and new apartment buildings during average and extreme weather conditions under a changing climate." *Applied Sciences* 11.9 (2021): 3972. <https://doi.org/10.3390/app11093972>.
- [2] "Finnish Meteorological Institute (Fmi). Heat Statistics (in Finnish)." accessed on 26 October 2022, (Available online): <https://www.ilmatiiteenlaitos.fi/jaahdytyksen-mitoituspaivat>.
- [3] S. Hosseini, P. Hajjaligol, M. Aghaei, S. Erba, V. Nik and A. Moazami, "Improving Climate Resilience and Thermal Comfort in a Complex Building through Enhanced Flexibility of the Energy System," 2022 International Conference on Smart Energy Systems and Technologies (SEST), Eindhoven, Netherlands, 2022, pp. 1-6, doi: 10.1109/SEST53650.2022.9898453.

# Leveraging Artificial Intelligence in Indoor Air Quality Management:

## *A Review of Current Status, Opportunities, and Future Challenges*



**SASAN SADRIZDEH**

PhD, Docent Professor  
ssad@kth.se

Recent advancements in the fields of artificial intelligence, machine learning, and the Internet of Things have created opportunities to improve the performance, safety, and energy efficiency of building ventilation. This report explores the current state of AI technologies in building ventilation and indoor air quality management by highlighting applications of technologies related to air quality monitoring, control, predictive maintenance, and energy optimization. The report also examines the ethical and data privacy issues associated with deploying these technologies and advocates AI integration in building HVAC systems by identifying future challenges and avenues for research.

**Keywords:** Artificial Intelligence, Machine Learning, Internet of Things, Indoor Air Quality, Building Ventilation, Occupants' Health, HVAC, Energy Efficiency

### Background

The heating, ventilation, and air conditioning (HVAC) industry is increasingly utilizing artificial intelligence (AI), machine learning (ML), and the Internet of Things (IoT) to enhance energy efficiency, indoor air quality (IAQ), thermal comfort, and occupant health. Integrating IoT and AI technologies to develop monitoring and controls will likely drive the growth of data-driven smart buildings [1]. ML algorithms that analyze sensor data can help with predictive maintenance, potentially reducing operational costs significantly [2,3]. AI-powered sensors and learning algorithms enable real-time adjustments to temperature, ventilation, and airflow based on occupancy patterns, which can help create an optimal indoor

environment [4]. Integrating IoT technology improves communication between various systems, which increases the overall efficiency of HVAC systems, resulting in occupant satisfaction and security. IoT-enabled devices provide real-time feedback on building performance, which is essential for achieving energy efficiency and sustainability objectives [5]. The intelligent building sector is likely to play a pivotal role in developing smart cities and transitioning towards a more sustainable and efficient built environment.

### Building Automation and Ventilation Design

An important building automation application is automated control systems. These systems employ sensors

to monitor the indoor environment and adjust the HVAC system accordingly. One example is developing an AI-based occupant-centric HVAC control mechanism for cooling, which continually enhances its knowledge to optimize energy consumption [6]. This system uses a combination of traditional and advanced control strategies, including soft and hard computing, hybrid strategies, and adaptive-predictive control strategies. Occupancy-related studies are also considered, and the HVAC system is optimized based on the needs of each individual.

Another important application of AI, ML, and IoT in building ventilation is predictive maintenance, which uses ML algorithms to predict when equipment is likely to fail so that maintenance can be performed in advance [7]. This approach can reduce downtime and maintenance costs while improving the reliability of the equipment. The approach uses data from various HVAC systems to predict when maintenance is needed.

With regard to air quality monitoring, IoT-based platforms enable daily monitoring of IAQ using sensors and feed real-time readings [8]. ML algorithms then analyze these data to identify patterns and trends in IAQ [9].

### **AI-driven HVAC systems and Occupants' Health**

Poor IAQ contributes to respiratory problems, allergies, and other health issues, and AI and ML can help monitor and enhance IAQ. For example, a hybrid approach combining IoT and AI has been proposed in one smart city in China to measure the air quality index (AQI). A sensor node collects data on air quality parameters such as temperature, humidity, and particulate matter, and ML algorithms are then applied to analyze the collected data and predict the AQI [10].

Numerous case studies and empirical evidence have shown that AI effectively enhances building IAQ and occupant safety. An example is an AI-enabled energy-efficient system for HVAC that was developed and analyzed using a divergence-convergence-re-divergence process [11] and uses AI functions to optimize HVAC systems for energy efficiency. Another study proposed an intelligent IoT-cloud-based air pollution forecasting model using univariate time-series analysis for predicting air quality [12]. That model uses ML algorithms to analyze data collected by multiple IoT sensors that are deployed in various locations to give decision-makers accurate and timely information about air quality trends.

### **AI and HVAC Energy Optimization**

AI technologies can help optimize energy consumption in HVAC systems. Implementing ML algorithms helps predict equipment failures, making it possible to conduct preventive maintenance promptly. As a result, downtime and maintenance costs can be minimized while equipment reliability is enhanced [13]. AI-based algorithms can be employed to optimize an HVAC system's energy consumption. For example, an AI-based occupant-centric HVAC control mechanism has been developed for cooling, which consistently enhances its knowledge to optimize energy consumption. This system incorporates a combination of traditional and advanced control strategies, including soft and hard computing, hybrid strategies, and adaptive-predictive control strategies [14].

IoT devices can be used to monitor energy consumption in buildings. For example, smart meters enable real-time energy consumption monitoring and give occupants feedback on their energy usage [15]. ML algorithms can analyze collected data to detect energy consumption patterns and trends, and this information can be used to optimize energy usage and lower energy costs.

A cost-benefit analysis should be conducted when considering whether to implement AI and IoT in an HVAC system. Although such technologies can reduce costs and enhance energy efficiency, initial investments in hardware and software are required. One study proposed an AI-based fuzzy inference system that employs IoT operating systems to monitor and optimize energy consumption for home energy management systems in smart buildings [15].

### **Ethical and Privacy Concerns**

Deploying AI and IoT in the management of IAQ can raise ethical and privacy concerns, particularly regarding data security. Some air quality monitoring systems could be susceptible to cyber intrusions, which can jeopardize the integrity of collected data and potentially provide misleading information [16]. Therefore, enhancing the security and integrity of data in these systems is vital. Mrissa et al. [17] introduced a privacy-aware and secure decentralized air quality monitoring system that leverages edge computing to process data and ensure data security. This system, which employs distributed ledger technology to ensure data privacy and security, was successfully demonstrated in a case study at a primary school in Slovenia.

Ethical considerations are crucial in using AI and IoT technologies in IAQ management. Because these technologies hold immense potential for both positive and potentially harmful applications, developers must be aware of their dual-use nature [18]. Ethical AI development requires transparency, fairness, and algorithmic ethics to ensure that AI systems are accountable and aligned with human values and rights [19]. There are significant ethical concerns regarding the potential of AI to perpetuate biases, discriminate, and exacerbate existing inequalities [20]. Accordingly, bias and ethics must be addressed through broad data collection and distribution throughout the AI development process to prevent biased or unethical AI development [19]. When adopting AI and IoT, it is also necessary to safeguard privacy and protect data, which includes adhering to relevant laws and ethical guidelines to offset regulatory gaps.

### Opportunities and Future Challenges

Certain technological gaps must be addressed to capitalize on the potential of AI and IoT in IAQ management. One concern is the transparency and accuracy of IAQ data monitoring solutions [21]. The use of low-cost sensors in IAQ monitoring systems has raised concerns about the quality of the generated data, which has made it necessary to improve the accuracy and reliability of these sensors [21]. Another challenge is the lack of interoperability and standardization among IoT devices used in IAQ management [22]. Establishing compatibility and standardization protocols ensures smooth communication and seamless data exchange among IoT devices.

Robust policy and regulation frameworks are essential in order to successfully utilize AI and IoT in IAQ management. Establishing policies and regulations that effectively address ethical considerations, privacy concerns, data security, and the interoperability and standardization of IoT devices is vital. Policies and regulations also need to account for the potential risks and unintended consequences of deploying AI and IoT. It is not only the immediate benefits that need to be considered but also the broader implications for humanity, the environment, and future generations in order to ensure a comprehensive and responsible approach to implementation [18].

The technological gaps and policy and regulation challenges in deploying AI and IoT in IAQ management can be addressed via several research directions. The first is to focus on developing low-cost sensors that are more accurate and reliable for IAQ monitoring,

aiming to enhance the quality of data collected [21]. The second is the development of AI-based algorithms that can optimize energy consumption in HVAC systems while maintaining IAQ standards.

Research is also necessary to shape policies and regulations that tackle ethical and privacy concerns, data security, and the interoperability and standardization of IoT devices. These policies should advance transparency and fairness, safeguard user privacy, and help achieve seamless communication and collaboration among IoT devices. Finally, research should also evaluate the long-term societal impact and potential risks and consequences of using AI and IoT in IAQ management [18].

### Conclusion

Using AI in IAQ management has promise in terms of enhancing the health and well-being of building occupants while optimizing energy consumption. Research has shown that integrating AI technologies in building ventilation is effective in areas such as automated control systems, predictive maintenance, and air quality monitoring, improving IAQ, reducing energy costs, and ensuring a comfortable and healthy indoor environment for building occupants.

However, ethical and privacy concerns need to be addressed in order to ensure responsible implementation and technological gaps and policy and regulation challenges still need to be overcome in order to capitalize on the potential of these technologies fully. While leveraging AI in IAQ management involves significant opportunities, future efforts must be directed toward ongoing research and development to address these challenges and unleash the full potential of these technologies. ■

### Acknowledgment

In line with the subject of this article on artificial intelligence, AI tools were utilized for language refinement, enhancing clarity and conciseness. The author takes full responsibility for the content of the manuscript.

### References

Please find the complete list of references in the html-version at <https://www.rehva.eu/rehva-journal>

...But to be sure,  
**trust Eurovent  
certification instead.**

When it comes  
to product performance,  
**you can ask  
a clairvoyant...**



## Trust is our business

**With Eurovent certification, you can be sure  
you're making an eco-friendly choice for reliable,  
sustainable HVAC-R products.**

Reduce your carbon footprint with confidence,  
opt for Eurovent certification.

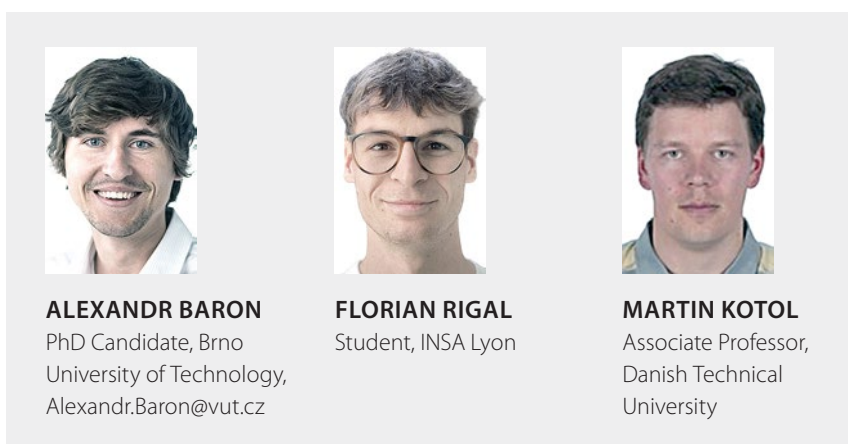


[www.eurovent-certification.com](http://www.eurovent-certification.com)

Eurovent Certita Certification is recognised as a world leader in third-party product performance certification in the Heating, Ventilation, Air Conditioning, and Refrigeration fields.

# Indoor Environment in Arctic Dwellings and Possible Improvements

– *With Special Focus on Overheating*



A large proportion of newly build Arctic dwellings suffers from overheating due to well insulated and air tight envelopes, low air change, and large windows. According to the WHO, temperatures above 24°C may cause thermal discomfort. In buildings above the Arctic Circle this is becoming more and more common, even though the outside temperatures are low. Interviews, indoor environment measurements and computer simulations were performed in four new homes in Sisimiut, Greenland to analyse the magnitude of the overheating phenomenon. Based on the results, a sensitivity analysis was carried out to find suitable solutions to improve the indoor climate.

**Keywords:** indoor climate; overheating; extreme climates; ventilation; dynamic simulation; arctic dwellings; CO<sub>2</sub> concentration; solar shading

## Current situation with indoor climate in Greenlandic dwellings

In the Arctic the buildings are exposed to extreme climates with extremely low temperatures, high wind speeds and solar radiation distributed unevenly throughout the year (unavailable in winter and very high during summer). In Sisimiut for example the winter average temperatures lay at -16.6°C while the maximum summer temperature rarely exceeds +10°C. The windspeeds often exceed 20 m/s. The snow cover stays until late May and the solar radiation of the low spring sun combined with large albedo effect results in potentially large solar gains. (Schrot et al., 2019).

For economic reasons and lack of experience, balanced ventilation systems are often avoided entirely or not designed to the Arctic demands. It is also not uncommon that buildings are only equipped with mechanical exhaust and natural ventilation intakes on the facade. The natural vents are often sealed by the occupants to reduce the cold draught and thermal discomfort. All in all, the ventilation rates are frequently reduced below recommended levels (Kotol et al., 2014).

The combination of 1) modern building techniques with highly insulated and airtight envelopes and thus low heat loss despite the harsh climate; 2) reduced

ventilation rates and 3) large solar gains; naturally increases the risk of overheating.

Many of the overheating mitigation strategies from milder climates such as window opening, external passive or active shading cannot be used successfully due to extreme weather conditions. However, other solutions can help to mitigate overheating, such as increased air change using ventilation system, interior or in-glass integrated shading or reduced solar heat gain coefficient of windows (Mavrogiani et al., 2014; Yu et al., 2023). The behaviour of the occupants and correct heating system design and control can also have a great effect as found in (Andersen et al., 2009; Haas et al., 1998).

Our investigation aimed to study the indoor climate in four recently built homes in Sisimiut, Greenland and to compare it with traditional houses from previous studies and standard requirements. Furthermore, by means of simulations we studied possible overheating mitigation strategies.

### Characteristics of the studied buildings

The study was performed in 4 single family homes built between 2015 and 2017. They are three-bedroom houses with a heated floor area of 104 m<sup>2</sup>. The houses are wooden structures on concrete strip foundations. The wooden frame is insulated with glass wool insulation and average U-value of the external walls is 0.12 W/(m<sup>2</sup>·K). The windows are triple glazed with argon providing a Ug-value of 1.1 W/(m<sup>2</sup>·K) and g-value of 0.59. The houses are heated with water-based floor heating system supplied by individual oil boiler. The floor heating is controlled individually in each room via room thermostat. Ventilation units contain a cross flow plate heat exchanger with 75% efficiency, according to the technical documentation. The air flow can be adjusted manually between low, medium and high speed. The occupied rooms have intake and exhaust and are thus balanced ventilated on a room level.



**Figure 1.** Newly built dwellings in Sisimiut, west Greenland.

### IAQ measurements and interview method

We measured T+RH in all the occupied rooms plus CO<sub>2</sub> in bedrooms from May to July 2023. Ventilation

airflows were measured with a flowmeter at each air diffuser at all three speed modes. Then, the results were compared with the Greenlandic Building Regulation (Oqartussat, 2006) (GR).

The correct function of floor heating was verified via comparison between pictures from the infrared camera and thermostat settings. If the temperature of the internal air of the room is lower than the thermostat setting of the room, floor heating should be turned on and visible in the taken photos.

To understand better the habits of the users, interviews were made with all the owners of the assessed houses. We studied the patterns concerning the use of shading, when and how long they open windows, what was their perceived IAQ in the house and their habits concerning the use of mechanical ventilation.

### Simulations

The simulations were done using IDA ICE. The climate file used was obtained using ERA5 and Asiaq's data. Internal gains and their schedules have been set based on conducted studies, best practices and conversations with occupants.

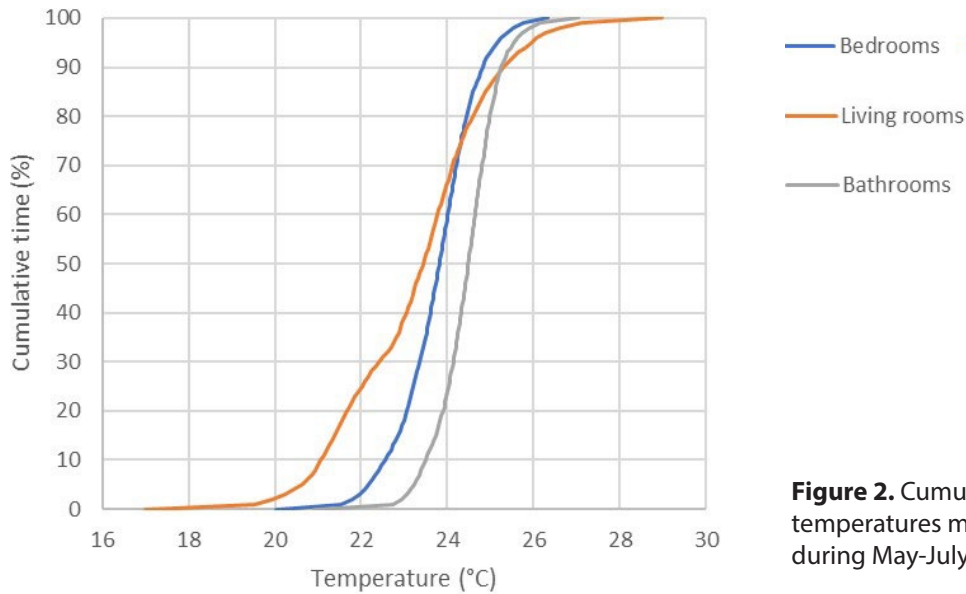
After validation of the model, the following parameters, their combination and their effect on overheating were studied: a) the SGHC factor of window panes; b) the speed of the AHU unit; c) the usage of openings for natural ventilation; d) the type of shading e) the combination of best resulting parameter of each class (a – d) of the variations. The assessed combinations sorted into categories are in **Table 1**.

### Results

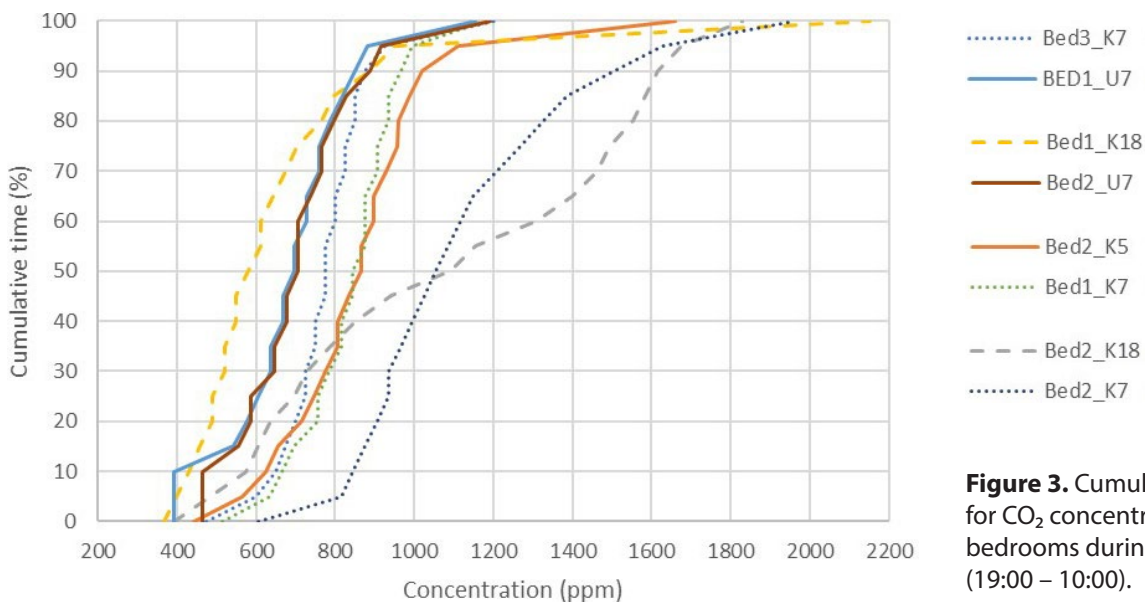
Measured indoor temperatures frequently exceeded 24°C and, in some periods even 26°C. **Figure 2** shows temperatures in living rooms in each house (K5; K7; U7; K18). Elevated temperatures (over 24°C) appear in all houses for over 25% of measured time and exceed 26°C for up to 10% (U7). The U7 house experiences the greatest temperature range (14°C to 30°C during the monitoring period). We noticed that the U7 house owners are trying to mitigate overheating by keeping their windows open for most of the time which results in the significantly low temperatures once the solar gains disappear at the end of the day.

Cumulative graphs for CO<sub>2</sub> concentration during night time (19:00 – 10:00) are presented in **Figure 3**. Most bedrooms experience CO<sub>2</sub> concentrations ▶





**Figure 2.** Cumulative graphs of living room temperatures measured in four houses during May-July



**Figure 3.** Cumulative graphs for CO<sub>2</sub> concentration in the bedrooms during nighttime (19:00 – 10:00).

**Table 1.** List of scenarios simulated for overheating assessment.

Category	Name in graph	Brief description
AHU flowrate setting	AHU – low	Setting of AHU with a minimum airflow (94 m <sup>3</sup> /h)
	AHU – medium	Setting of AHU with a medium airflow (228 m <sup>3</sup> /h)
	AHU – high	Setting of AHU with a high airflow (306 m <sup>3</sup> /h)
Natural ventilation	NatVent 5	Windows opened for 5 min per day
	NatVent 10	Windows opened for 10 min per day
	NatVent 60	Windows opened for 60 min per day
	NatVent 10%	Windows opened all day but only on 10% of its area
SGHC	Validation	0,36
	SGHC 20	0,20
Shading	Validation	Internal drapes
	Mid panes	Blinds placed between window panes in a cavity opened to the outside air through vents, drawn when solar radiation level exceeds 100 w/m <sup>2</sup>

- ▶ above 1000 ppm for less than 10% of the night time. The highest mean concentration was measured in bedroom 2 of K18 house and is 1093 ppm. The highest percentage of time with CO<sub>2</sub> concentration above 1000 ppm is the bedroom 2 of the K7 house (occupied by four people) with 55% of the time. The U7 house results show the lowest concentrations that meet the 1000 PPM level requirement for the longest period of time.

### Air flow measurements

The measurements of actual air flows showed that 1/3 of all the rooms is slightly under ventilated according to the Greenlandic Building Code. This was also confirmed by the results of the CO<sub>2</sub> monitoring. We believe this is simply due to improper regulation as the units have the capacity to meet the requirements. During the measurements we discovered that one of the K houses had very low or non-existent exhaust air flow at the low-speed setting. We assume that this was due to clogged return filter. As a result, the house was permanently over-pressured which is not desirable as this leads to indoor moisture being pushed into the construction.

### Simulations

Simulation results for all scenarios presented in the method are shown **Figure 4**.

When assessing solutions for overheating, the minimum resulting temperature should not be neglected either. When opening the windows, the cold air immediately

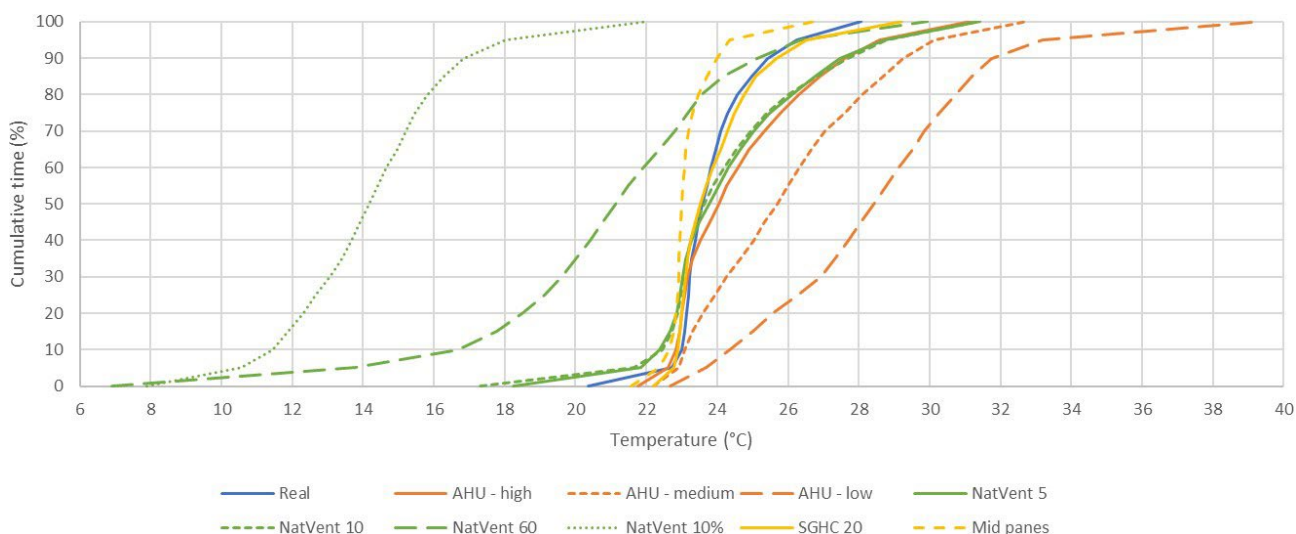
enters the rooms, creating drafts and reducing the temperature too much. Therefore, the scenario with the window opened all day on 10 % of its area (NatVent 10 %) may be without overheating, but results in too low temperatures causing thermal discomfort. This was also seen in the living room of U7 house.

The integrated shading solution shows temperature levels in a comfortable range. It means that there is no excessive overheating, no cool periods either and that the temperatures obtained are very consistent throughout the period. The shading blocks the radiation from entering the interior and can be cooled down thanks to its position in the outermost ventilated cavity.

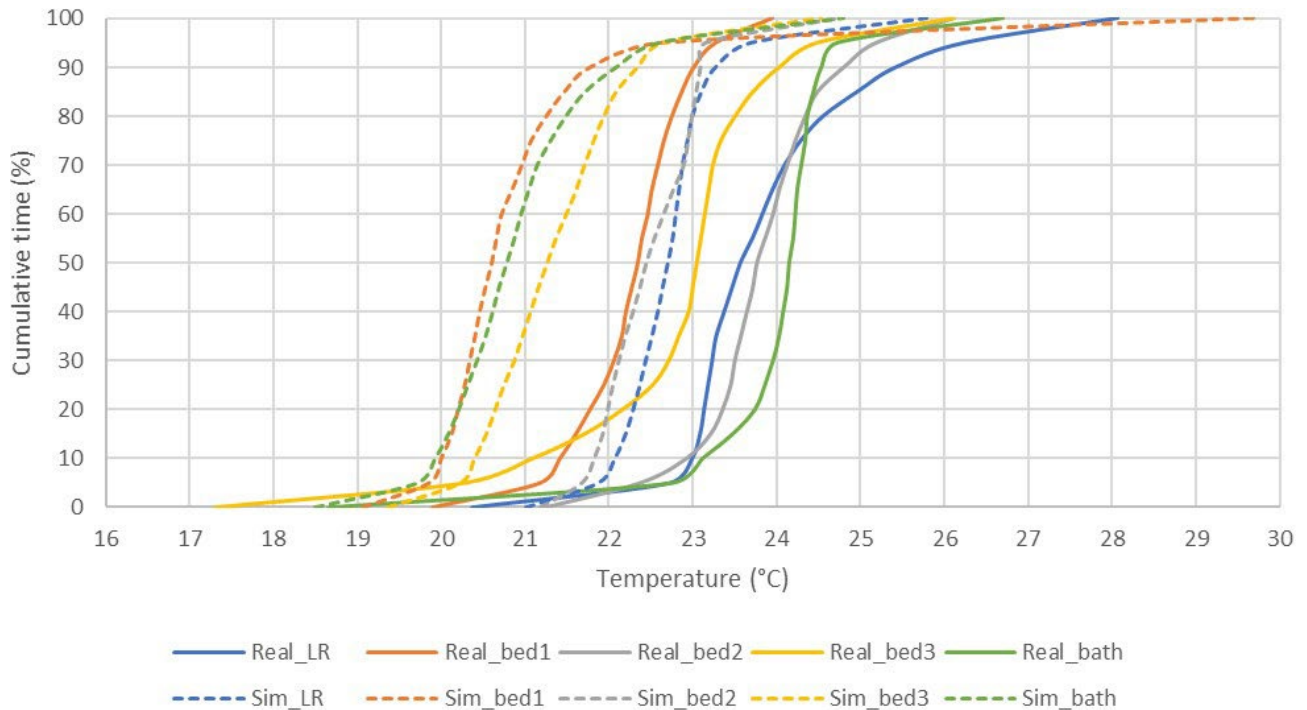
**Figure 5** presents measured temperatures (Real) and simulated best-case scenario (Sim) for each room of the K18 house. The results indicate, that excessive temperatures can be reduced significantly using a combination of integrated shading, increased air flows in ventilation system, and the g-value of 0,2. Temperatures would still exceed 24°C (elevated temperature) but for less than 5% of the time which we consider acceptable.

### Conclusions

The study shows that new buildings in the Arctic experience solar overheating through large windows even though they are equipped with modern balanced ventilation systems. The ventilation systems are not designed to cool the interior (by increasing the air flow and by-passing the heat exchangers) when needed and the interior shadings and window opening does not



**Figure 4.** Cumulative graphs of the simulated scenarios.



**Figure 5.** Measured and simulated (the best-case scenario) temperatures.

solve the problem either. Our simulations showed that with higher ventilation rates and the implementation of different (more suitable) technology such as integrated window shading and optimized solar heat gain coefficients on some windows, it is possible to improve the

thermal comfort substantially. Additionally, we believe that regular maintenance, proper commissioning and appropriate user instructions will lead to better IAQ and thermal comfort of the occupants. ■

## References

- Andersen, R. V., Toftum, J., Andersen, K. K., & Olesen, B. W. (2009). Survey of occupant behaviour and control of indoor environment in Danish dwellings. *Energy and Buildings*, 41(1), 1116. <https://doi.org/10.1016/j.enbuild.2008.07.004>.
- Bjarløv, S. P., & Vladykova, P. (2011). The potential and need for energy saving in standard family detached and semi-detached wooden houses in arctic Greenland. *Building and Environment*, 46(8), 15251536. <https://doi.org/10.1016/j.buildenv.2010.12.004>.
- Haas, R., Auer, H., & Biermayr, P. (1998). The impact of consumer behavior on residential energy demand for space heating. *Energy and Buildings*, 27(2), 195205. [https://doi.org/10.1016/S0378-7788\(97\)00034-0](https://doi.org/10.1016/S0378-7788(97)00034-0).
- Kotol, M., Rode, C., Clausen, G., & Nielsen, T. R. (2014). Indoor environment in bedrooms in 79 Greenlandic households. *Building and Environment*, 81, 2936. <https://doi.org/10.1016/j.buildenv.2014.05.016>.
- Mavrogianni, A., Davies, M., Taylor, J., Chalabi, Z., Biddulph, P., Oikonomou, E., Das, P., & Jones, B. (2014). The impact of occupancy patterns, occupant-controlled ventilation and shading on indoor overheating risk in domestic environments. *Building and Environment*, 78, 183198. <https://doi.org/10.1016/j.buildenv.2014.04.008>.
- Oqartussat, N. (2006). Ineqarnermut Attaveqarnermullu Pisortaqarfik.
- Schrot, O. G., Christensen, J. H., & Formayer, H. (2019). Greenland winter tourism in a changing climate. *Journal of Outdoor Recreation and Tourism*, 27, 100224. <https://doi.org/10.1016/j.jort.2019.100224>.
- Yu, Y., Shao, Y., Zhao, B., Yu, J., Guo, H., & Chen, Y. (2023). Study on Summer Overheating of Residential Buildings in the Severe Cold Region of China in View of Climate Change. *Buildings*, 13(1), Article 1. <https://doi.org/10.3390/buildings13010244>.

International Conference

# World Sustainable Energy Days 2024

5 – 8 March 2024  
Wels/Austria



**ENERGY  
TRANSITION NOW –  
FAST, SMART,  
RESILIENT!**

## Conferences:

- European Energy Efficiency Conference
- European Pellet Conference
- Industrial Energy Efficiency Conference
- Smart E-Mobility Conference
- Young Energy Researchers Conference
- Workshop "Cities and regions"

[www.wsed.at](http://www.wsed.at)

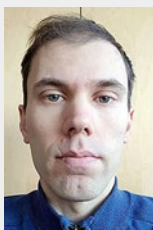


# The characteristics of airborne transmission with convective and radiant cooling systems



**WEIXIN ZHAO**

D.Sc (Tech),  
Aalto University  
weixin.zhao@aalto.fi



**SIMO KILPELÄINEN**

D.Sc (Tech), laboratory,  
manager, Aalto University



**RISTO KOSONEN**

Full-Professor,  
Aalto University



**JUHA JOKISALO**

D.Sc (Tech), senior  
scientist, Aalto University

The enclosed indoor environments are high-risk spaces for airborne transmission if spaces are densely occupied and poorly ventilated. Based on the recognized airborne infection risk, there is a raised demand to develop innovative micro-environment ventilation systems to mitigate the airborne transmission risk indoors. Air distribution is playing a significant role and to reach same concentration level in the breathing zone mixing ventilation requires much higher airflow rate than micro-environment solution.

**Keywords:** Airborne transmission, Infection risk, Micro-environment system, Air distribution, Heat gain level

## Airborne transmission and air distribution

The COVID-19 pandemic was an extremely urgent threat to human life, and similar outbreaks may occur in the future. Based on WHO recommendations, ventilation systems are critical for reducing the infection risk for COVID-19. Understanding the characteristics and mechanism of aerosol transmission is important when applying effective practices for epidemic control.

Airborne transmission comes from the inhalation of aerosol droplets which are exhaled by an infected person. The exhaled aerosol droplets from an infected person transmitting to an exposed person is a combined

interaction of various airflows, including the breathing flow, human body boundary layer flow, and the ventilation flow. The airflow pattern can have a significant effect on the distribution of infectious aerosol spatial and temporal concentrations in an occupied zone beyond the simple effect of an increased ventilation rate in the assumed fully mixed conditions. Therefore, more novel air distribution should be introduced to reduce the individual's exposure to air pollutants and infection risks. The target should be only to control the air quality close to the breathing zone. There could also be a need to introduce more advanced systems where users can influence their local micro-environment.

## Convective and radiant cooling systems

This paper will introduce three air distribution methods, included two micro-environment systems and a perforated duct system, which is described in **Figure 1**. In personalized ventilation combined with radiant panel (PVRP) system (**Figure 1 a**), a PV (personalized ventilation) air terminal device (ATD) was installed on the desk at a distance of 40 cm from the simulated person to supply fresh air directly to the breathing zone [1]. In low velocity unit combined with radiant panel (LVRP) system (**Figure 1 b**), low velocity unit was installed just over the radiant panels and the air was supplied through those panels [2].

Diffuse ceiling ventilation was used to provide background ventilation outside the occupied zone. The perforated duct was located in the middle of the upper room space. The length of perforated duct was 5.5 m, and the diameter of the perforated duct was 200 mm. The supply air temperature was 17 °C with two micro-environment systems and 14 °C with the perforated duct system. With the perforated duct system, the supplied airflow was 116 l/s and 61 l/s with the 73 W/m<sup>2</sup> and 38 W/m<sup>2</sup>, leading to air change rates of 5.5 h<sup>-1</sup> and 2.9 h<sup>-1</sup>, respectively. With the PVRP and LVRP systems, the total supply airflow rate was 42 l/s with 38 W/m<sup>2</sup> and 73 W/m<sup>2</sup> and the air change rate was 2.2 h<sup>-1</sup>. The rest of the cooling load was covered by the radiant panel.

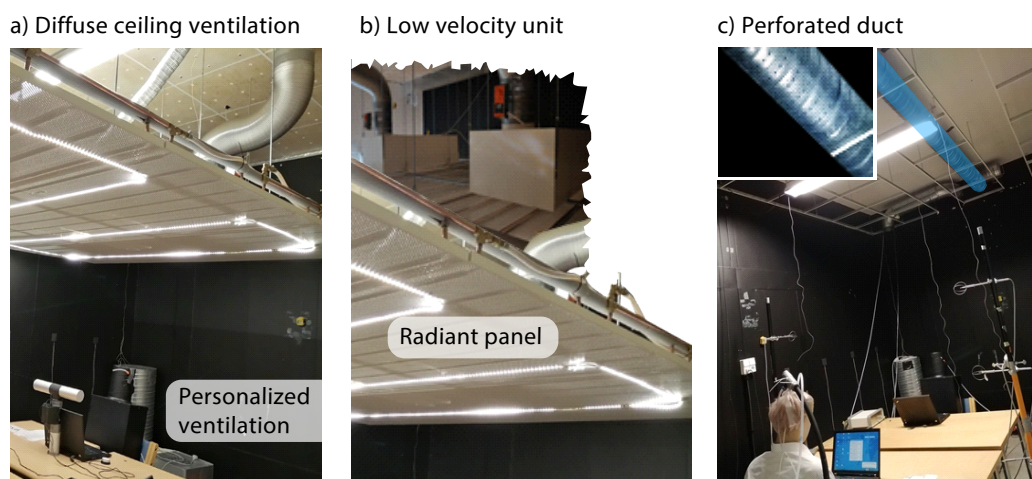
The thermal breathing manikin consisted of 27 separately heated body segments and was used for the infected sitting person simulation (referred to below as the infector). The manikin was connected to an artificial lung to simulate real human breathing. The designed

pulmonary ventilation rate was 6.0 l/min. Each breathing cycle consisted of 2.5 seconds of inhalation, 1.0 second break, 2.5 seconds of exhalation and 1.0 second break. In this experiment, tracer gas SF<sub>6</sub> was utilized to simulate the virus-containing droplet nuclei in the exhaled air from the infector manikin at flow rate of 2 ml/s.

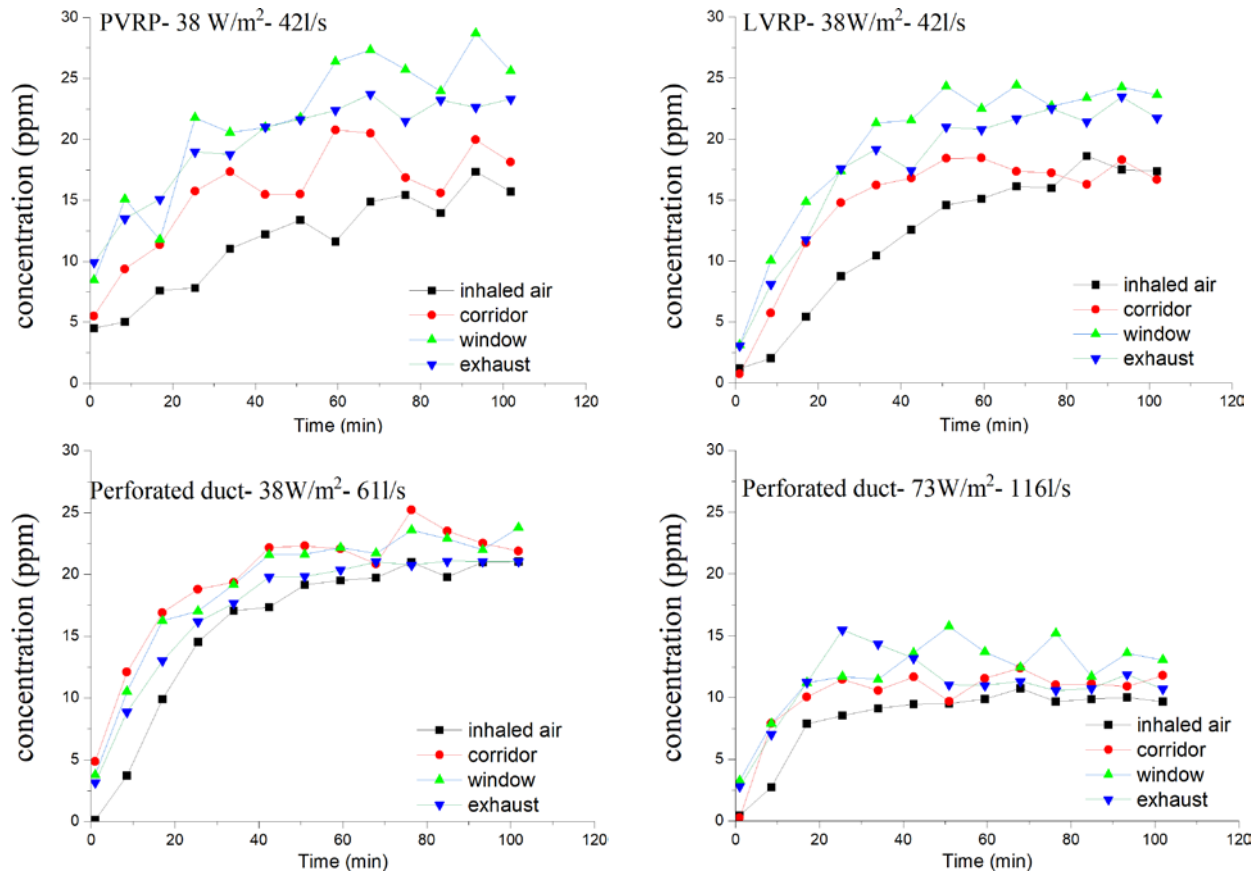
## Infection risk with three air distribution methods

**Figure 2** shows the tracer gas concentrations with two micro-environment and one fully mixed air distribution methods from t=0 to 102 min at different measured locations. With the perforated duct system, the concentration of the inhaled air of the exposed person was slightly higher than two micro-environment systems with airflow rate of 61 l/s. This is because the local airflow of micro-environment systems protects the contaminant transmission from the infector compared with the fully mixed condition. With two micro-environment systems (PVRP and LVRP), the inhaled concentration of the exposed person was much lower than at the other locations in the test room. Moreover, compared to the LVRP system (15 l/s per person), the SF<sub>6</sub> concentration with the PVRP system was slightly lower at the exposed person even with less local airflow rate (7 l/s per person).

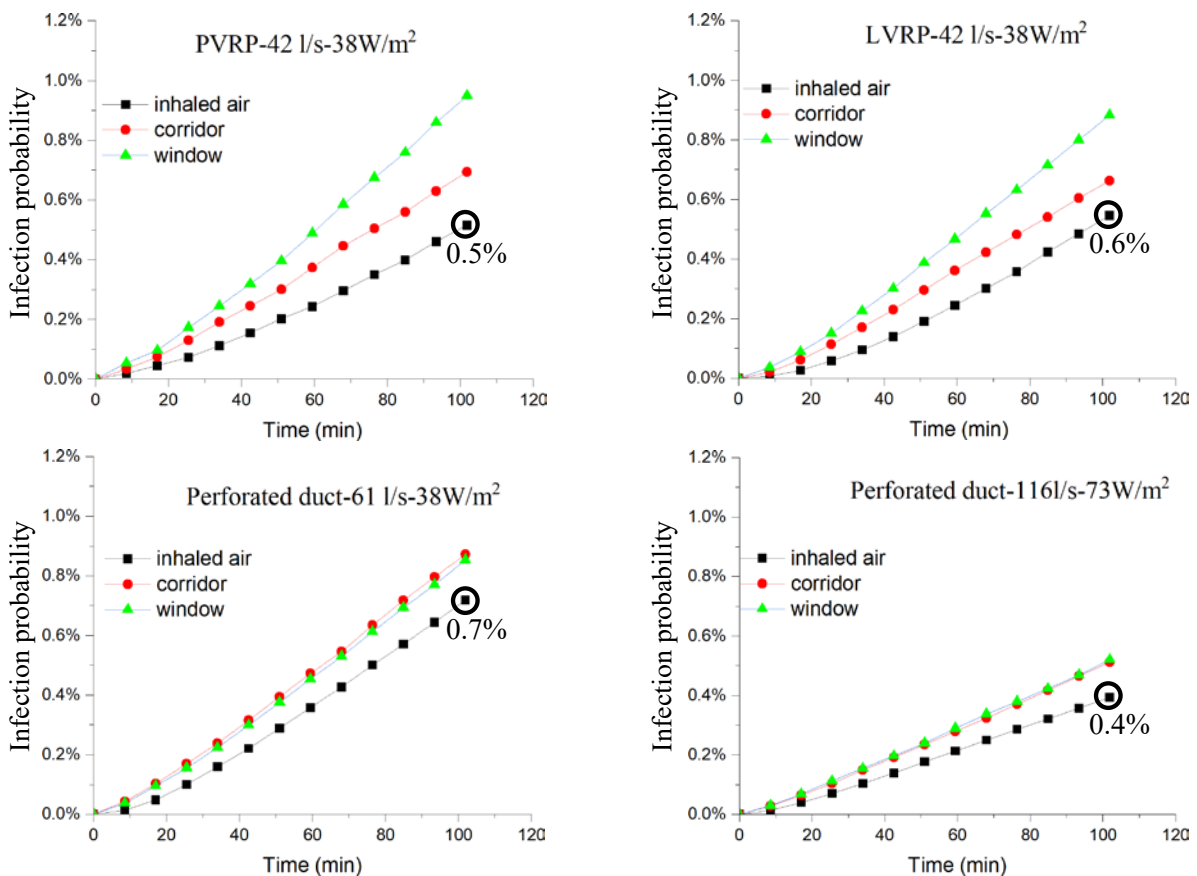
The airborne infection risk was calculated according to the dilution-based Wells-Riley model [3]. The quantum generation rate of a COVID-19 infector was assigned to be 5 quanta/h for office work. **Figure 3** shows that the infection risk that was the lowest for the inhaled air of the exposed person with all systems.



**Figure 1.** The setup of ventilation systems, a) personalized ventilation combined with radiant panel (PVRP), b) a low velocity unit combined with radiant panel (LVRP), c) perforated duct.



**Figure 2.** Measured tracer gas concentrations at different locations over time with two micro-environment (PVRP and LVRP) and one fully mixed (perforated duct) air distribution systems.



**Figure 3.** The airborne infection risks at different locations over time calculated using the dilution-based Wells-Riley model.

This indicates that indoor air is not fully mixing in the test room with any of the analyzed air distribution methods. It should be noted that with the micro-environment systems, the variation in the infection risk at the different locations was larger than the perforated duct system. The infection risk of the exposed person after 102 min was 38%, 26%, and 11% lower than that on the window side with PVRP, LVRP, and perforated duct system, respectively. This indicates that the micro-environment systems are able to better reduce the airborne transmission risk in the inhaled air than the perforated duct. The infection risks at the inhaled air measurement point were 0.6% and 0.5% with the LVRP and PVRP systems, respectively. This result shows that PVRP system was slightly superior to the LVRP system for the protective effect.

With the perforated duct system, the infection risk of the exposed person decreased from 0.7% to 0.4% when the airflow rate increased from 61 l/s to 116 l/s after 102 minutes. Compared with the micro-environment systems (0.5% -0.6% with 42 l/s), the infection risk of the exposed person was lower with an airflow rate of 116 l/s (0.4%). This depicts clearly that air distribution is player significant role in infection risk, and fully mixed ventilation requires in this case around 2 times higher airflow rate to have lower infection risk than micro-environment system.

## Conclusion

The adaptation of micro-environment systems can help supply the local airflow from a personalized ventilation or low velocity unit to the occupant breathing zone directly. Based on the results, the concentration was lower with the micro-environment systems than fully mixed air distribution. The infection risk of the exposed person was around 0.5% with the micro-environment systems (42 l/s) and 0.7 % (61 l/s) with

the perforated duct system after 102 minutes. In this measurement, fully mixed ventilation requires around 2 times higher airflow to have lower infection risk than micro-environment system. ■

## Acknowledgement

The study was supported by SUOJAILMA project funded by the Finnish Work Environment Fund (Grant No. 210099). HEATCLIM (Heat and health in the changing climate, Grant Numbers. 329306, 329307) funded by the Academy of Finland within the CLIHE (Climate change and health) Programme.

## Reference

- [1] Zhao Weixin, Kilpeläinen Simo, Kosonen Risto, Jokisalo Juha, Lestinen Sami, & Mustakallio Panu. (2020). Thermal environment and ventilation efficiency in a simulated office room with personalized micro-environment and fully mixed ventilation systems. *Building and Environment*, 107445. <https://doi.org/10.1016/j.buildenv.2020.107445>.
- [2] Zhao Weixin, Kilpeläinen Simo, Kosonen Risto, & Jokisalo Juha. (2020). Experimental comparison of local low velocity unit combined with radiant panel and diffuse ceiling ventilation systems. *Indoor and Built Environment*, 1420326X20918398.
- [3] Zhang, Sheng, and Zhang Lin. "Dilution-based evaluation of airborne infection risk-Thorough expansion of Wells-Riley model." *Building and Environment* 194 (2021): 107674.



# Demand response of space heating for a district heated office building in Finland



**YUCHEN JU**  
Doctoral candidate,  
Aalto University  
yuchen.ju@aalto.fi



**PAULI HILTUNEN**  
Doctoral candidate,  
Aalto University



**JUHA JOKISALO**  
D.Sc., Senior scientist,  
Aalto University



**RISTO KOSONEN**  
Full-Professor,  
Aalto University



**SANNA SYRI**  
Professor,  
Aalto University

The benefits of demand response control of space heating were evaluated for a district heated office building. A rule-based demand response control strategy was introduced. Based on the results, district heat energy costs were reduced by 9.6% through demand response control of space heating without sacrificing thermal comfort.

**Keywords:** district heating; demand response, rule-based control, marginal cost

## Introduction

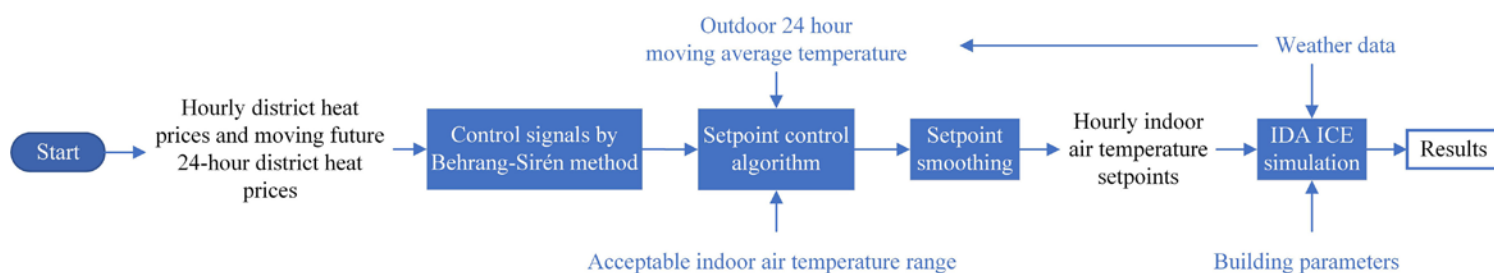
In Finland, district heat accounted for 45% of the market for space heating in public, commercial, and residential buildings in 2020 (Finnish Energy 2022). Initiatives aimed at the energy sector's decarbonization should be developed since Finland plans to be carbon neutral by 2035 (Finnish Government 2019).

Demand side management is the approach linked to integration of more renewable energies in the future. It could adjust consumer demand to follow the unstable energy generation by renewable sources (Gelazanskas and Gamage, 2014). Consumers can gain monetary benefits simultaneously.

However, few studies have taken advantage of dynamic marginal costs of district heating generation for building-level demand response. Therefore, a rule-based demand response control strategy was designed based on dynamic district heat prices calculated by the marginal costs. The aim is to investigate the benefits that can be gained for a district heated building. In this study, a Finnish office building was selected for analysis.

## Building simulation process

**Figure 1** introduces the demand response process of space heating. Control signals were determined by the variation of dynamic district heat prices.



**Figure 1.** Demand response control process of space heating.

In order to shift the space heating demand, several indoor air temperature setpoints were chosen for the demand response control. To further avoid the rebound effect, the setpoint smoothing approach was used based on the study of Ju et al. (2021).

### Simulated building

A typical Finnish office building constructed in 1980s in Espoo was chosen in this study. It has been renovated several times. **Table 1** lists the building parameters. It was connected to a conventional high-temperature DH network to cover space heating by water radiators, ventilation, and domestic hot water (DHW). The U-values were defined by the Finnish building code (Ministry of the Environment, 1985). The designed indoor air temperature was set at 21°C during the heating season (Ministry of the Environment, 2016).

**Table 1.** Properties of the simulated office building.

Parameters	Office Building
Heated net floor area (m <sup>2</sup> )	2383
Floor number	4
Envelope area (m <sup>2</sup> )	3855
Window/envelope area	9.5%
U-Value of external walls (W/m <sup>2</sup> ·K)	0.28
U-Value of roof (W/m <sup>2</sup> ·K)	0.22
U-Value of ground slab (W/m <sup>2</sup> ·K)	0.36
U-Value of windows (W/m <sup>2</sup> ·K)	1.00
Air leakage rate, n <sub>50</sub> (1/h)	1.60
Usage time	8 a.m.–4 p.m. (workdays)
DHW heating energy demand (kWh/m <sup>2</sup> )	6
Actual peak heating power demand (kW)	113.2

### District heat prices and weather data

The demand response benefits during the heating season from October 2021 to April 2022 were analyzed in this study. The hourly DH prices with 24% VAT are shown in **Figure 2**. The details of the district heat price which was calculated based on the marginal cost of a district heating production in Espoo are shown in (Ju et al., 2023). The maximum price was 192.5 €/MWh. The weather data was gained from the Finnish Meteorological Institute (2023) for the same period. The minimum outdoor temperature was -19.8°C.

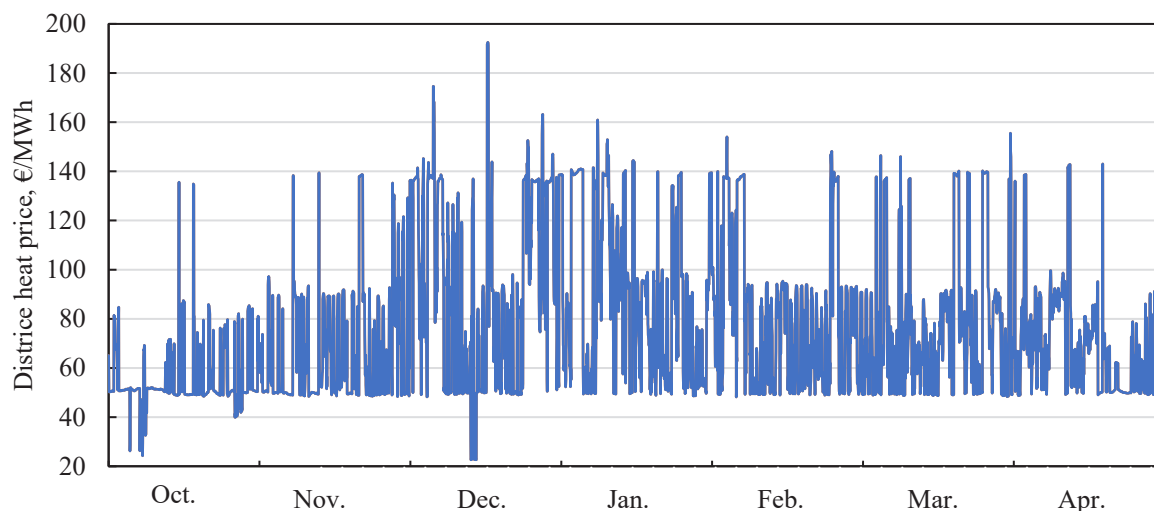
### Demand response control algorithm

In study, Behrang-Sirén method shown in Equation (1) was used to determine the price trend for controlling the indoor air temperature setpoints (Alimohammadisagvand et al., 2016). It assumed that the moving future 24-hour price was known. The price trend was decreasing (-1), increasing (+1), and flat (0). A marginal value of 15 €/MWh was selected for more sensitive to price variation.

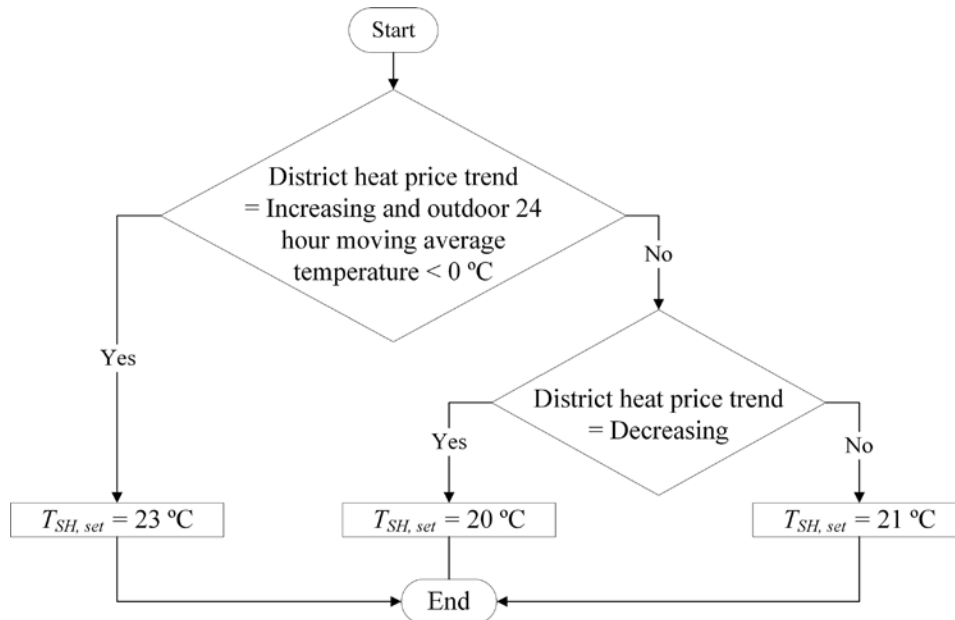
$$\begin{aligned}
 & \text{If } HEP < HEP_{avr}^{+1,+24} - \text{marginal value}, \text{ Then } CS = +1 \\
 & \text{Elseif } HEP > HEP_{avr}^{+1,+24}, \text{ Then } CS = -1 \\
 & \text{Else } CS = 0 \\
 & \text{End If}
 \end{aligned} \tag{1}$$

where  $HEP$  is hourly energy (district heat) price, €/MWh;  $HEP_{avr}^{+1,+24}$  is the moving future 24-hour district heat price, €/MWh.

**Figure 3** shows the demand response control algorithm. The hourly indoor air temperatures were controlled by the space heating system. When the

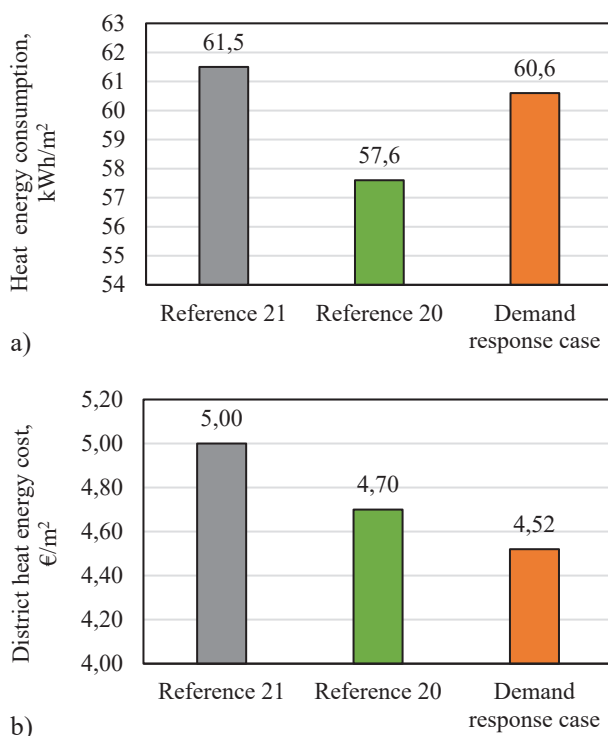


**Figure 2.** Dynamic district heat price during the heating season.



**Figure 3.** Setpoint control algorithm for space heating.

price trend was decreasing (high-price period), the indoor air temperature was at 20°C. It was set based on the thermal environmental category II of standard SFS-EN 16798-1 (2019). When the price trend was flat, the indoor air temperature setpoint was 21°C. The maximum indoor air temperature setpoint was 23°C for the increasing price trend (low-price period) (Suhonen et al., 2020). To prevent overheating, the outdoor 24-hour moving average temperature should be below 0°C or the indoor air temperature would not increase (Martin, 2017).

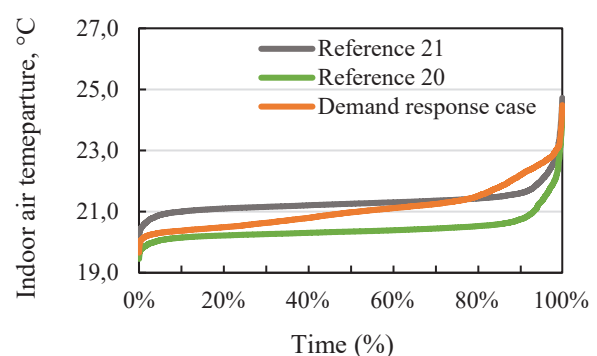


**Figure 4.** a) heat energy consumption; b) district heat energy cost.

## Results

**Figure 4** collects the heat energy consumption and district heat energy cost during the heating season with and without demand response. For the reference case Reference 21, the indoor air temperature was kept at 21°C. There is another reference with 20°C indoor air temperature setpoint for comparison. The district heat energy cost was calculated based on the district heat prices (see **Figure 2**). It illustrates that decreasing 1°C of the indoor air temperature reduces the heat energy consumption by 3.9 kWh/m<sup>2</sup> (6.2% compare with the reference case 21). However, although the demand response case only cuts the consumption by 0.9 kWh/m<sup>2</sup> (1.4%), it saves more of the district heat energy cost. The cost saving is about 0.5 €/m<sup>2</sup> which is 9.6%. Excluding the cost saving by decreasing the indoor air temperature, demand response control gained additional savings by storing heat during low-price period and using them when the district heat price was high.

**Figure 5** presents the heating season duration of indoor air temperatures of the office building's coldest room.



**Figure 5.** Duration curves of indoor air temperatures for the coldest room during the heating season.

For the reference 20 case, the minimum temperature is 19.5°C. Occupants stay in a lower indoor air temperature longer than in other cases. For the demand response case, the minimum temperature is 19.7°C. The difference to 20°C (the minimum indoor air temperature of the acceptable temperature range) is negligible. Therefore, the demand response control works without sacrificing thermal comfort.

## Conclusion

In this study, a district heated Finnish office building was selected to investigate demand response benefits. A rule-based demand response control strategy was designed based on dynamic district heat prices. The results show that the demand response control saves district heat energy costs by 9.6% without compromising thermal comfort. ■

## Reference

- Alimohammadisagvand, B.; Jokisalo, J.; Kilpeläinen, S.; Ali, M.; Sirén, K. Cost-optimal thermal energy storage system for a residential building with heat pump heating and demand response control. *Appl. Energy* **2016**, *174*, 275–287. <https://doi.org/10.1016/j.apenergy.2016.04.013>.
- Finnish Energy. Energy Year 2022—District Heating. Available online: (link html) (accessed on 3 May 2023).
- Finnish Government. Programme of Prime Minister Sanna Marin's Government 10 December 2019. Inclusive and Competent Finland—A Socially, Economically and Ecologically Sustainable Society. Available online: <http://urn.fi/URN:ISBN:978-952-287-811-3> (accessed on 1 July 2021).
- Finnish Meteorological Institute. Weather and sea—Download Observations. 2023. Available online: <https://en.ilmatieteenlaitos.fi/download-observations> (accessed on 28 January 2023).
- Gelazanskas, L.; Gamage, K. A. Demand side management in smart grid: A review and proposals for future direction. *Sustainable Cities and Society* **2014**, *11*, 22–30. <http://dx.doi.org/10.1016/j.scs.2013.11.001>.
- Ju, Y.; Jokisalo, J.; Kosonen, R.; Kauppi, V.; Janßen, P. Analyzing power and energy flexibilities by demand response in district heated buildings in Finland and Germany. *Science and Technology for the Built Environment* **2021**, *27* (10):1440–60. <https://doi.org/10.1080/23744731.2021.1950434>.
- Ju, Y., Hiltunen, P., Jokisalo, J., Kosonen, R., & Syri, S. Benefits through Space Heating and Thermal Storage with Demand Response Control for a District-Heated Office Building. *Buildings* **2023**, *13*(10), 2670. <https://doi.org/10.3390/buildings13102670>.
- Martin, K. 2017. Demand Response of Heating and Ventilation within Educational Office Buildings. Master's Thesis, Espoo, Finland: Aalto University, School of Engineering, Department of Energy Technology, HVAC. Available at: <https://aaltodoc.aalto.fi/handle/123456789/29149> (accessed on 04. Mar. 2021).
- Ministry of the Environment. *D3 Finnish Code of Building Regulation. Rakennusten Energiatohokkuus (Energy Efficiency of Buildings). Regulations and Guidelines*; Ministry of the Environment: Helsinki, Finland, 1985. (In Finnish).
- Ministry of Environment. Decree of the Ministry of the Environment on the Indoor Climate and Ventilation of New Buildings. Ministry of Environment. Helsinki. Finland, 2016. Available online: (link pdf) (accessed on 9 July 2023).
- SFS-EN 16798-1. 2019. Energy performance of buildings. Ventilation for buildings. Part 1: Indoor environmental input parameters for design and assessment of energy performance of buildings addressing indoor air quality, thermal environment, lighting and acoustics. Module M1-6. Finnish Standards Association (SFS). Helsinki.
- Suhonen, J.; Jokisalo, J.; Kosonen, R.; Kauppi, V.; Ju, Y.; Janßen, P. Demand response control of space heating in three different building types in Finland and Germany. *Energies* **2020**, *13* (23):6296. <https://doi.org/10.3390/en13236296>.

# Long-term performance analysis of a hybrid ground source heat pump system in Finland



**TIANCHEN XUE**  
 Doctoral candidate,  
 Aalto University  
 tianchen.xue@aalto.fi



**RISTO KOSONEN**  
 Full-Professor,  
 Aalto University



**JUHA JOKISALO**  
 Senior researcher,  
 Aalto University

This study investigated methods for improving the long-term performance of a hybrid GSHP system coupled to district heating and an air-cooled chiller. These methods include adjusting indoor air setpoints and dimensioning air handling unit (AHU) cooling coils. The system performance was analysed based on 25-year simulations in IDA ICE 4.8. By using the studied methods, the minimum outlet brine temperature was increased by around 3°C in the last heating season, the average heat pump COP in the last heating season was increased by 3 % and the share of the GSHP heating energy in the last heating season was improved by 2 percentage points. However, ensuring long-term operation still required extra solutions.

**Keywords:** Hybrid ground source heat pump, district heating, borehole free cooling, long-term performance analysis.

## Introduction

Ground source heat pumps (GSHPs) as high-efficiency solutions for providing heating and cooling have been widely used in European countries (Menegazzo et al. 2022). However, in cold regions, as buildings have the dominating heating demand, GSHP systems face the challenge of ground thermal imbalance. If the GSHP system is not designed properly, the ground temperature will be overcooled and lead to deterioration of the heat pump performance in a long run. In this context, hybrid GSHP systems with auxiliary heat source are proposed especially for cases with a limited land for drilling boreholes. Many studies revealed that integrating auxiliary heat source with the GSHP can assist to maintain a more stable ground temperature and generate a higher coefficient of performance (COP) of

the heat pump (Xi et al. 2011; Naranjo-Mendoza et al. 2019; Liu et al. 2017). However, some existing hybrid GSHP systems could still have imbalanced ground load if the system was controlled improperly.

Therefore, this study aims to investigate different methods for improving the long-term performance of a hybrid GSHP system in Finland with a risk of overcooled ground. The investigated methods include adjusting indoor heating and cooling setpoints and dimensioning air handling unit (AHU) cooling coils. The whole system was modelled and simulated in IDA Indoor Climate and Energy (IDA ICE) 4.8. The results of this paper could be helpful to the design and practical implementation of hybrid GSHP systems.

## Method

### Description of building model

In this study, the simulation software IDA ICE 4.8 (Sahlin 1996) was used for the modelling and simulation of the building and the hybrid GSHP system.

The case building is a new 4/5-storey educational building with hundreds of rooms in Espoo, Finland. The total heated net floor area is around 47,500 m<sup>2</sup>. The original building was designed in an irregular shape. The studied building was simplified as a rectangular building with five zones in the building model.

In the building model, U-values of the external wall, the roof and the base floor were set as 0.17 W/(m<sup>2</sup>K), 0.09 W/(m<sup>2</sup>K) and 0.18 W/(m<sup>2</sup>K), respectively. Each wall was equipped with one window featuring a U-value of 0.6 W/(m<sup>2</sup>K), solar heat transmittance of 0.49 and direct solar transmittance of 0.41. The total window to envelope ratio was 17.3 %. The air leakage rate of the building was 2 m<sup>3</sup>/(h, m<sup>2</sup>) under a pressure of 50 kPa.

The heating and cooling were distributed by a hydronic four-pipe radiant ceiling panel system. The indoor heating and cooling setpoints were set as 21.5°C and 25°C. The dimensioning supply/return water temperatures for space heating were 45/30°C. The supply

water temperature for space heating was controlled by the outdoor air temperature. The dimensioning supply/return water temperatures for space cooling were fixed at 15/18°C. The domestic hot water (DHW) was heated to 55°C. In the model, the annual heating energy demand of DHW was set as 4 kWh/(m<sup>2</sup>, a).

The ventilation system was a mechanical balanced ventilation system with heat recovery. The supply/return water temperatures for AHU cooling were set as 10/16°C. The supply air temperature was controlled between 16-18°C according to the outdoor air temperature. More details about the settings in the model can be found in the study by Xue et al. (2023).

### Description of hybrid GSHP system model

The main components of the hybrid GSHP system are the GSHP, the district heating substations, the air-cooled chiller and the storage tanks. The COP of the GSHP was 3.94 at rating conditions of 0/35°C. The energy efficient ratio (EER) of the air-cooled chiller was 3.04 at rating conditions of 35/7°C. The volumes of the hot and cold-water storage tanks were 5 m<sup>3</sup> and 3 m<sup>3</sup>, respectively.

Figure 1 shows a simplified schematic of the hybrid GSHP system. As the figure shows, the heating energy

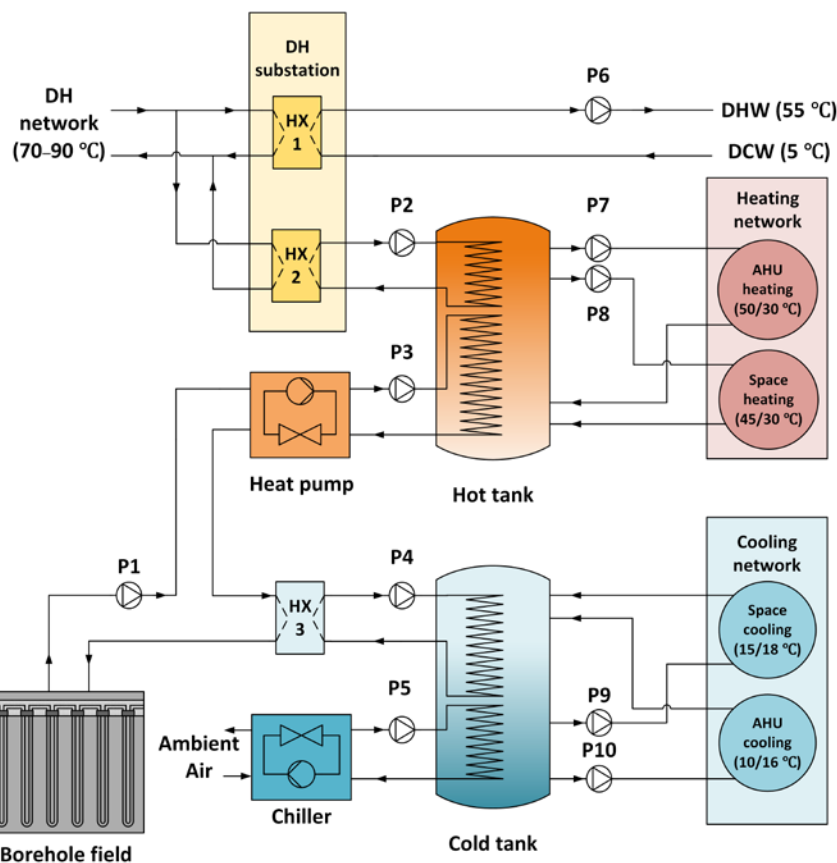


Figure 1. Simplified schematic of the hybrid GSHP system model.

to the heating network is supplied from the hot water storage tank which is primarily heated by the heat pump. If the water temperature of the top layer is lower than the required temperature for the heating network, the district heating will be used additionally. Besides, the district heating is also used for generating the DHW via a separate heat exchanger. The cooling network is connected to the cold-water storage tank in which the water is mainly cooled by free cooling from the borehole field. When the water temperature of the cooling tank bottom layer is lower than the required temperature for the cooling, the air-cooled chiller will be used as the back-up cooling.

The borehole field in this study was modelled by IDA ICE ground heat exchanger (IDA ICE GHX) module. There are 74 groundwater-filled boreholes in the borehole field with an average length of 310 m. The borehole heat exchangers are single U-tubes filled with 28% ethanol-water. In the modelling, the original borehole field layout (see **Figure 2(a)**) was simplified as a double-symmetry layout (see **Figure 2(b)**). The borehole field models were described detailedly by Xue et al. (2022). In their work, the simplified borehole field model was validated against the measured brine temperature.

### Definition of simulated cases

Four different cases were designed to compare different performance-improving methods. Case 1 is the reference case with settings from the actual design. In Case 2, the AHU cooling water supply/return temperatures were increased to 15/18°C to use more free cooling in summer. However, it also implies larger cooling coils in the AHUs. Case 3 is designed based on Case 2, while the cooling setpoint is reduced to 22.5°C to further increase the ground cooling load. In Case 4, a lower heating of 21°C is used for purpose of reducing the ground heating load.

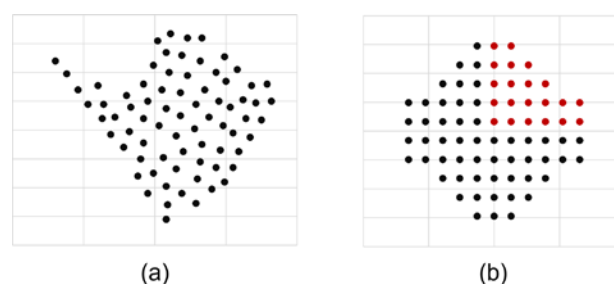
The long-term simulations were conducted separately for each studied case. The simulation period

was from July 2019 to June 2044. To generate the 25-year weather data, the measured weather data from 2019 to 2021 was used periodically for 25 years. The measured weather data was obtained from the nearest weather station.

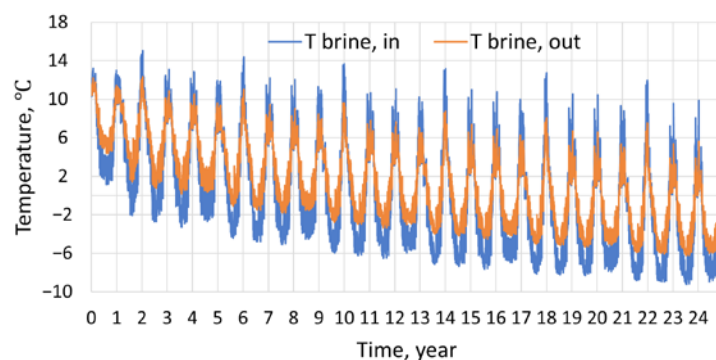
## Results

### Brine temperatures

**Figure 3** shows the curves of inlet and outlet brine temperatures of the borehole field from Case 1 (reference case). As the figure shows, inlet and outlet brine temperatures of the borehole field drop significantly after 25 years.



**Figure 2.** Borehole field layouts, (a) original layout, (b) simplified layout.



**Figure 3.** Borehole field inlet and outlet brine temperatures (reference case).

**Table 1.** Properties of studied cases.

Case	AHU cooling water temperatures, °C	Heating setpoint, °C	Cooling setpoint, °C
Case 1 (ref)	10/16	21.5	25
Case 2	15/18	21.5	25
Case 3	15/18	21.5	22.5
Case 4	15/18	21	22.5

**Table 2** shows the inlet and outlet brine temperatures in the first and last years. In Case 1, the minimum outlet brine temperature during the heating season drops from 4.4°C to -6.0°C after 25 years. In Case 2, by increasing the AHU cooling water temperature level, the minimum outlet brine temperature in the last year has no change while the maximum outlet brine temperature is reduced compared to Case 1. The reason for this could be the accumulated injected heat is decreased as the condensation in AHUs is reduced because of a higher AHU cooling water temperature level. In Case 3, the lower indoor air cooling setpoint results in higher brine temperatures in the last cooling season. However, it is also noticed the brine temperatures are higher in the last heating season, which could be due to the seasonal storage effect. In Case 4, further reducing the heating setpoint can further increase the brine temperatures in the last heating season. However, the minimum outlet brine

temperature in the last heating season of Case 4 can only reach to -3.1°C, which is still lower than the required minimum outlet brine temperature of 0°C for Nordic countries (Gehlin et al. 2016).

### Hybrid GSHP performance

**Tables 3 and 4** show the hybrid GSHP performance of different cases in the first and last years, respectively. It can be seen the average COP of GSHP in the heating season decreases after 25 years. In Case 1, the average COP in the last heating season is 3.42, which is 9 % lower than that in the first heating season. The COP reduction leads to the deterioration of the GSHP heating capacity. The share of GSHP heating energy reduced from 95 % to 90 % after 25 years. However, in the cooling season, the free cooling is benefited from the reduced brine temperature which is presented by the increased share of borehole free cooling in the last year.

**Table 2.** Comparison of inlet and outlet brine temperatures.

Case	1st year				25th year			
	Heating season		Cooling season		Heating season		Cooling season	
	$T_{in,min}, ^\circ C$	$T_{out,min}, ^\circ C$	$T_{in,max}, ^\circ C$	$T_{out,max}, ^\circ C$	$T_{in,min}, ^\circ C$	$T_{out,min}, ^\circ C$	$T_{in,max}, ^\circ C$	$T_{out,max}, ^\circ C$
Case 1 (ref)	1.1	4.4	13.2	12.2	-8.9	-6.0	9.9	5.6
Case 2	1.1	4.4	14.6	12.8	-8.9	-6.0	9.4	5.3
Case 3	1.8	4.9	15.2	13.1	-6.1	-3.4	12.4	8.5
Case 4	2.0	5.1	15.2	13.1	-5.7	-3.1	12.4	8.3

**Table 3.** Comparison of hybrid GSHP performance in the first year.

Case	Heating season					Cooling season			
	Average COP of GSHP	GSHP heating energy, MWh	Back-up District heating energy, MWh	Total heating energy, MWh	Share of GSHP heating energy, %	Borehole free cooling energy, MWh	Chiller cooling energy, MWh	Total cooling energy, MWh	Share of borehole free cooling energy, %
Case 1 (ref)	3.76	2984	154	3139	95	217	212	429	51
Case 2	3.76	2983	151	3134	95	290	94.7	385	75
Case 3	3.78	3168	180	3348	95	392	154	546	72
Case 4	3.78	2966	139	3106	96	389	155	544	72

**Table 4.** Comparison of hybrid GSHP performance in the last year.

Case	Heating season					Cooling season			
	Average COP of GSHP	GSHP heating energy, MWh	Back-up District heating energy, MWh	Total heating energy, MWh	Share of GSHP heating energy, %	Borehole free cooling energy, MWh	Chiller cooling energy, MWh	Total cooling energy, MWh	Share of borehole free energy, %
Case 1 (ref)	3.42	2801	321	3122	90	420	11.6	432	97
Case 2	3.42	2799	317	3117	90	384	0.1	384	100
Case 3	3.51	3011	332	3343	90	547	4.9	552	99
Case 4	3.51	2840	255	3095	92	546	5.4	551	99



Compared with the reference case, it can be noticed that among three proposed methods, only reducing the cooling setpoint (Case 3) presents an improved heat pump COP. In Case 2, increasing the AHU supply water temperature level only leads to an increase on the share of borehole free cooling in the total supplied cooling energy. In Case 4, the reduced heating setpoint only benefits the share of GSHP heating energy in the system. Finally, in Case 4 in which all three improving methods was applied, the average heat pump COP in the last heating season was increased by 3 % and the share of GSHP heating energy in the last heating season was improved by 2 percentage points.

## Conclusion

Different methods for improving the long-term performance of a hybrid GSHP were investigated based on 25-year simulations in IDA ICE 4.8. The conclusions are summarized as follows:

- a) The reference case showed a significant decrease in the borehole field outlet brine temperature after 25 years. The brine temperature drop led to decreases in the COP of GSHP and the share of GSHP heating energy after 25 years. However, the decreased brine temperature caused a substantial increase in the borehole free energy.
- b) The overcooling of the ground can be alleviated by the studied methods. In the case with a higher AHU cooling water temperature level and lower cooling and heating setpoints, the minimum outlet brine temperature in the last heating season was increased by around 3°C compared to the reference case. As a result, the average heat pump COP in the last heating season was increased by 3 % and the share of the GSHP heating energy in the last heating season was improved by 2 percentage points.
- c) Considering the overcooling cannot be eliminated by the proposed methods, additional solutions, such as reducing the GSHP power or adding more back-up heating, could be still needed for ensuring the sustainable operation of the hybrid GSHP system. ■

## Acknowledgments

The authors would like to thank Antti Säynäjoki and Tuomo Uusitalo from Aalto University Campus & Real Estate and Mika Vuolle from EQUA Simulation Finland Ltd. for their kind cooperation.

## References

- Gehlin, Signhild EA, JD Spitler, and G Hellström. 2016. "Deep Boreholes for Ground Source Heat Pump Systems—Scandinavian Experience and Future Prospects." *ASHRAE Winter Meet.* 2013: 23–27.
- Liu, Zhijian, Wei Xu, Xue Zhai, Cheng Qian, and Xi Chen. 2017. "Feasibility and Performance Study of the Hybrid Ground-Source Heat Pump System for One Office Building in Chinese Heating Dominated Areas." *Renewable Energy* 101: 1131–40. <https://doi.org/10.1016/j.renene.2016.10.006>.
- Menegazzo, Davide, Giulia Lombardo, Sergio Bobbo, Michele De Carli, and Laura Fedele. 2022. "State of the Art, Perspective and Obstacles of Ground-Source Heat Pump Technology in the European Building Sector: A Review." *Energies* 15 (7). <https://doi.org/10.3390/en15072685>.
- Naranjo-Mendoza, Carlos, Muiyiwa A. Oyinlola, Andrew J. Wright, and Richard M. Greenough. 2019. "Experimental Study of a Domestic Solar-Assisted Ground Source Heat Pump with Seasonal Underground Thermal Energy Storage through Shallow Boreholes." *Applied Thermal Engineering* 162 (August): 114218. <https://doi.org/10.1016/j.applthermaleng.2019.114218>.
- Sahlin, Per. 1996. "Modeling and Simulation Methods for Modular Continuous Systems in Buildings." *Department of Building Sciences, Division of Building Services*.
- Xi, Chen, Lu Lin, and Yang Hongxing. 2011. "Long Term Operation of a Solar Assisted Ground Coupled Heat Pump System for Space Heating and Domestic Hot Water." *Energy and Buildings* 43 (8): 1835–44. <https://doi.org/10.1016/j.enbuild.2011.03.033>.
- Xue, Tianchen, Juha Jokisalo, and Risto Kosonen. 2023. "Design of High-Performing Hybrid Ground Source Heat Pump." *Buildings* 13 (7). <https://doi.org/https://doi.org/10.3390/buildings13071825>.
- Xue, Tianchen, Juha Jokisalo, Risto Kosonen, Mika Vuolle, Federica Marongiu, Sami Vallin, Nina Leppäharju, and Teppo Arola. 2022. "Experimental Evaluation of Ida Ice and Comsol Models for an Asymmetric Btes Field in Nordic Climate." *SSRN Electronic Journal* 217 (April). <https://doi.org/10.2139/ssrn.4106273>.

# Performance evaluation of a Heat Valve ventilation and heating system for residential buildings



**ALIREZA AFSHARI**

Department of the Built Environment (BUILD), Aalborg University Copenhagen, Denmark



**GÖRAN HULTMARK**

Department of the Built Environment (BUILD), Aalborg University Copenhagen, Denmark



**JOANNA POLAK**

Lindab Comfort A/S, Farum, Denmark

The study introduces a new combined air heating and ventilation system designed for residential buildings, particularly effective in temperate climates. This innovative system, featuring Heat Valves, allows for the independent regulation of air temperature in each room using a single heating coil. It efficiently combines heating and ventilation, offering precise control over indoor temperatures while minimizing energy consumption. The system's design and performance were thoroughly evaluated through laboratory experiments and practical application in a building, demonstrating its potential in enhancing residential heating and ventilation efficiency.

## Introduction

In temperate climate zones, characterized by mild summers and cold winters, a substantial portion of a building's total energy use attributed to space heating has necessitated thermal insulation and air tightness. To enhance building energy efficiency further, mechanical ventilation systems with heat recovery from the exhaust air are typically required [1]. Consequently, due to the improved air tightness of buildings and the need for heat recovery, mechanical ventilation systems are increasingly being used in residential buildings.

The significant reduction in the need for space heating, combined with the presence of mechanical ventilation systems in buildings, presents excellent opportunities for space heating systems that utilize air as a heat distribution medium.

These systems are well-suited for low-energy buildings, where the necessary heating energy can be supplied at an airflow rate that is close to the minimum required for ventilation [2]. The lower the demand for space heating, the less additional energy is required to heat the supply air and to operate the fan.

A combined air heating and ventilation system is an economically viable option, particularly in terms of installation and maintenance costs, as it eliminates the need for a separate heat distribution system. Additionally, the lower thermal inertia of air heating systems compared to water heating systems can be considered an advantage, owing to their faster response time and, consequently, more precise regulation of the system.

Several constraints associated with conventional systems, primarily concerning the challenge of achieving desirable thermal conditions in individual rooms, hinder the successful implementation of air heating systems in residential buildings [3-6]. Enabling air temperature control in each room can significantly enhance occupant satisfaction regarding thermal conditions.

This project evaluates the performance of a novel, combined air heating and ventilation system. The unique feature of this system is its ability to precisely control the temperature in each room independently, using just a single heating coil. A full-scale

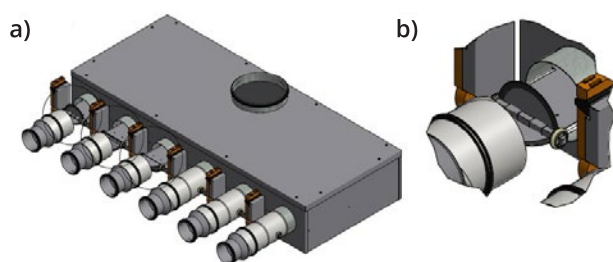
prototype of the proposed system was constructed and analyzed in a laboratory experiment, aimed at characterizing and assessing the impact of the system's design on its performance. Furthermore, the system's performance was also evaluated in a building.

## Design of the system

In the proposed system, air is supplied at a constant airflow volume (CAV). The conditioning of the supply air to a specific temperature occurs initially in the air handling unit, where it is filtered and heated in the heat recovery unit. Subsequently, the air is distributed through the main supply duct to a manifold located in an apartment or single-family house. The primary function of this manifold is to divide the total supply airflow rate into separate ducts that serve the corresponding rooms. Within the manifold, the supply air is further heated and then delivered to each room through these supply ducts to meet the individual heating and ventilation requirements of the rooms.

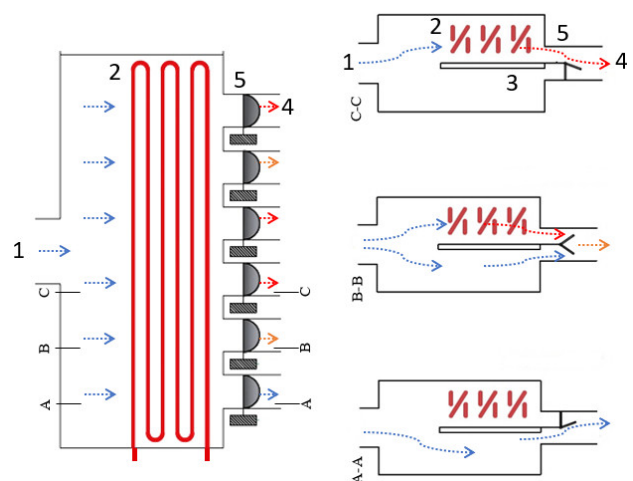
The airflow pattern through the manifold is determined by the positions of Heat Valves, which are installed at each outlet of the manifold, **Figure 1**. Each heat valve comprises two blades mounted on a rotary axle, with the angle between the blades being fixed. The position of each heat valve dictates the proportion of air that either passes through or bypasses the heating coil. However, it's important to note that the position of the heat valve does not affect the total airflow rate in the corresponding supply ducts.

**Figure 2** depicts the design of the manifold, which receives supply air (1) from the air-handling unit. The manifold is divided into two sections: the upper section (2) contains a built-in heating coil, while the lower section (3) is unoccupied. An insulation layer separates these two parts to inhibit heat transfer between them. This design enables the supply air to either flow through the heating coil or bypass it, allowing for the mixing of air to achieve the desired temperature (4).



**Figure 1.** Illustration of the manifold – the 3D view (a), the heat valve detail (b).

The position of the heat valve can be adjusted from 0% (as depicted in **Figure 2**, Vertical Cross-Section A-A) to fully open at 100% for heating (**Figure 2**, Vertical Cross-Section C-C). When the heat valve is set anywhere between 0% and 100% (**Figure 2**, Vertical Cross-Section B-B), the air delivered to the corresponding duct is divided into two flows: heated and unheated. These flows are then combined after passing through the heat valve (5). This configuration enables continuous and independent regulation of the supply air temperature at each outlet of the manifold.



**Figure 2.** Illustration of the airflow pattern through the manifold.

The position of each heat valve, and consequently the temperature of the supply air in the corresponding duct, is adjusted by an actuator based on signals from a room controller. This controller continuously measures the room's temperature and compares it to a user-defined set point. Depending on the difference between these two values, the heating output from the manifold in the corresponding supply duct is adjusted by the Heat Valves to maintain the desired temperature in the room.

## Results

During the continuous operation of the system under investigation, the quantity of air that either passes through or bypasses the heating coil varies, depending on the position of the Heat Valves. To characterize the relationship between the heat valve position and the supply air temperature in the corresponding supply duct, the supply air temperature was measured while altering the position of the Heat Valve.

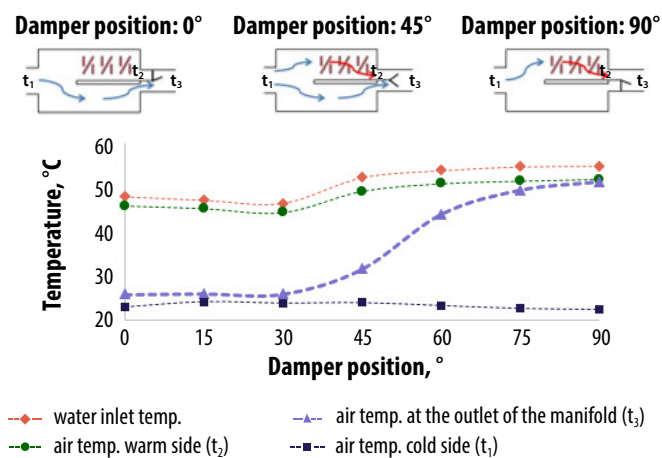
**Figure 3** shows the air temperature measured at various positions across the manifold with different settings of the Heat Valve. 'Air temp cold side  $t_1$ ' refers to the

temperature of the supply air from the air handling unit. 'Air temp warm side  $t_2$ ' indicates the air temperature after it passes through the heating coil. 'Air temp at the outlet of the manifold  $t_3$ ' represents the temperature of the air supplied to the room. 'Water inlet temp' denotes the temperature of the water fed into the heating coil. The heating coil's efficiency allows the manifold to supply air to the rooms at a temperature that is only marginally lower than the temperature of the supply water.

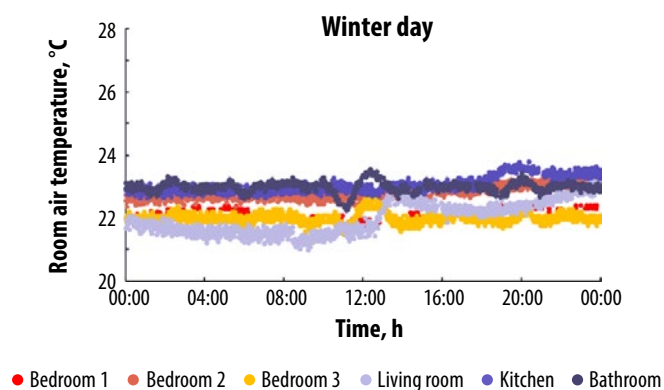
During the operation of the proposed system in an actual building, **Figure 4**, temperature regulation in the rooms was accurately maintained, due to the low thermal inertia of air the heating system.

## Conclusions

The investigations showed that incorporating the manifold with Heat Valves into the new combined system permits the independent regulation of the supply air temperature at each outlet of the manifold, thereby enabling control of the air temperature in each room.



**Figure 3.** Air temperature measured across the manifold in relation to the heat valve position.



**Figure 4.** Indoor air temperature measured in a house with 6 rooms during a winter day.

The maximum temperature of the supply air is determined by the heating capacity of the coil, the temperature of the supply water, and thermal losses through the manifold and ductwork. Conversely, the minimum supply air temperature is defined by the outdoor air temperature, the extract air temperature, and the efficiency of the heat recovery unit.

This study introduces a new combined air heating and ventilation system designed for residential buildings. The system's innovative feature is its ability to regulate the supply air temperature in individual ducts using just one heating coil, thereby facilitating temperature control in each room. The findings demonstrate that utilizing Heat Valves enables precise air temperature control in each room. ■

## References

- [1] M. Iivonen, Deep energy renovation, the effect of airtightness and heat recovery in renovation projects, *REHVA Journal*, Vol. 4, 57-60, 2022.
- [2] W. Feist, J. Schnieders, V. Dorer, A. Haas, Re-inventing air heating: Convenient and comfortable within the frame of Passive House concept, *Energy and Buildings*, Vol. 37, 1186-1203, 2005.
- [3] M. Berge, H. M. Mathisen, The suitability of air-heating in residential passive house buildings from the occupants' point of view – a review, *Advances in Building Energy Research*, Vol. 9, no. 2, 175-189, 2015.
- [4] M. Berge, H. M. Mathisen, Perceived and measured indoor climate conditions in high-performance residential buildings, *Energy and Buildings*, Vol. 127, 1057-1073, 2016.
- [5] M. Berge, J. Thomsen, H. M. Mathisen, The need for temperature zoning in high-performance residential buildings, *Journal of Housing and Built Environment*, Vol. 32, 211-230, 2017.
- [6] M. Berge, L. Georges, H. M. Mathisen, On the oversupply of heat to bedrooms during winter in highly insulated dwellings with heat recovery ventilation, *Building and Environment*, Vol. 106, 389-401, 2016.
- [7] G. Gan, Evaluation of room air distribution systems using computational fluid dynamics, *Energy and Buildings*, Vol. 23, 83-93, 1995.
- [8] E. Ridouane, Evaluation of thermal comfort in low load homes supplied by high sidewall air jets, *ASHRAE Transactions*, Vol. 118, 322-329, 2012.
- [9] A. Prozuments, A. Borodinecs, Indoor air stratification in warm air supply systems, *ASHRAE Journal*, Vol. 59, 54-65, 2017.
- [10] J. Polak, A. Afshari, P. Sadeghian, C. Wang, S. Sadrizadeh, Improving the performance of heat valve ventilation system: A study on the provided thermal environment, *Building and Environment*, Vol. 164, 106338, 2019.

# Commissioning process is required to guarantee high performance of hybrid systems



**JOHANNES SIMOLA**

M.Sc, Energy Efficiency Expert,  
Lassila & Tikanoja  
johannes.simola@lassila-tikanoja.fi



**RISTO KOSONEN**

Full-Professor,  
Aalto University



**SIMO KILPELÄINEN**

D.Sc., laboratory manager,  
Aalto University

The use of hybrid heating systems and energy recycling systems based on several heat sources has grown rapidly. Those hybrid systems implemented are complex, and it has often been noticed that there are often faults in the operation. To guarantee the performance designed, the commissioning process over the life-cycle needs to be conducted by an experienced engineer.

**Keywords:** heat pump, hybrid heating system, district heating, HVAC commissioning process

## Background

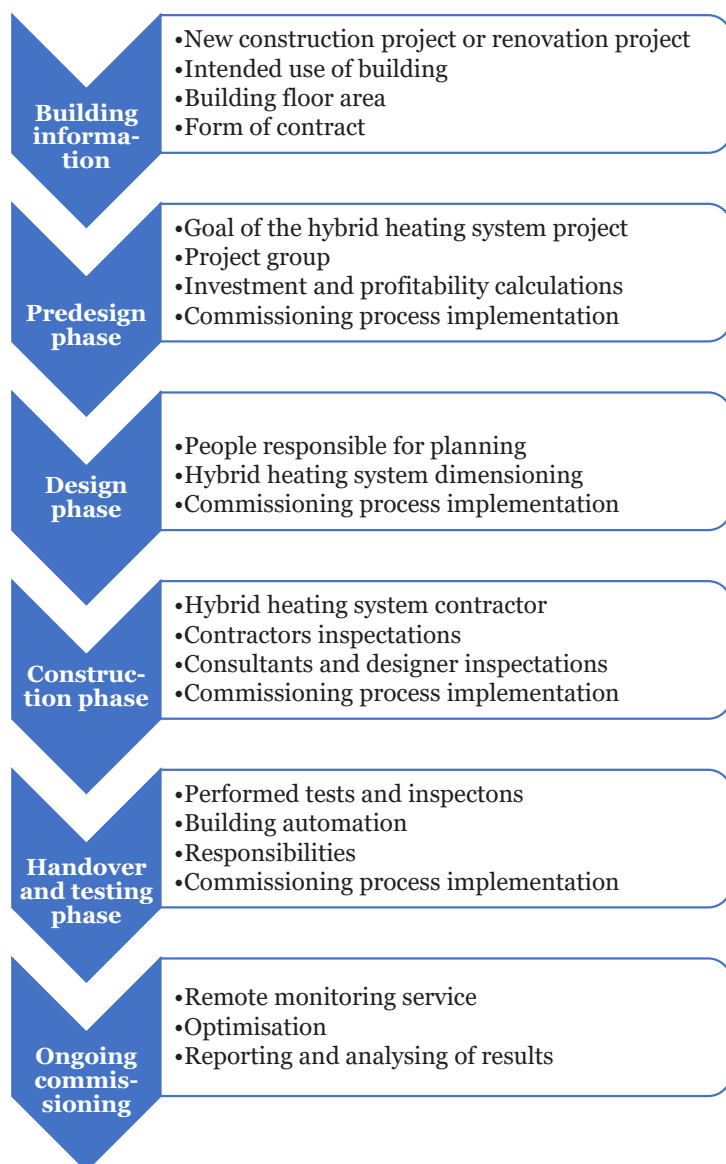
To reach the emission targets, the primary energy consumption of the buildings has to be reduced and efforts must be made to use decarbonized heat production methods. Using waste heat and using renewable energy sources (RES) with heat pumps (HPs) are very effective ways to reduce heating power demand and energy consumption. With the help of hybrid heating systems, which combine different heat generation methods, it is possible to achieve low carbon dioxide (CO<sub>2</sub>) emissions. However, to reach the full potential of these systems, the operation should be always guaranteed.

Hybrid heating systems are becoming more technical, and they can utilize several heat sources. The commissioning process and monitoring of system operation become very important issues in guaranteeing the cost saving targeted.

## Methods

In this study, the commissioning process of eight real estates was analyzed. The handover of those buildings happened 1-4 years ago. All the case buildings were located in Southern Finland and equipped with modern automation systems.

Hybrid heating system implementation, operation, and the commissioning process were analyzed in the case buildings. Design documents related to the hybrid heating system project were also obtained from some of the case buildings. With the help of an initially created checklist focusing on different phases of the construction process, the key personnel were interviewed (**Figure 1**). Thus, an insight into the implementation and commissioning process of the hybrid heating system, from project predesign to system operation and follow was obtained. Interviewed stakeholders included HVAC designers, consultants, supervisors, equipment suppliers, customer representatives, and contractors.



**Figure 1.** Basic information collected of the case buildings.

## Analyzed case buildings

The eight case buildings that were the subject of the research and interviews varied in gross floor area between 9 000 m<sup>2</sup> and 100 000 m<sup>2</sup>, so large properties were chosen as the case buildings for the study. The types of properties included residential buildings, office buildings, schools, shopping centers, and multi-purpose buildings.

In **Table 1**, a description of the case buildings is presented. In the table, the type of building, the building size, and the type of hybrid heating system are shown.

## Commissioning Implementation in Case Buildings

The commissioning process is not understood in Finland as it is described in the ASHRAE and REHVA guidelines [1,2,5]. In Finland, it is understood purely cover the testing and handover phases. The reason for this is related to the instructions in the Finnish RT HVAC commissioning guidelines, where the commissioning process is started during the construction phase [3-4].

When the commissioning process is not started earlier than the construction phase, it cannot address the errors and problems that appear in the project predesign and detailed design phases. In all the case buildings investigated in this study, the RT instructions on the HVAC commissioning process were at least partially followed in the operational verification. The RT instructions guideline on commissioning are quite comprehensive and considers also heating and cooling systems [3-4]. However, it was possible to notice from the case buildings that they had not been implemented as comprehensively as stated in the Finnish RT instructions [3-4]. Some of the process steps were clearly omitted in the case buildings.

The title of commissioning provider is quite often confused with HVAC supervisor. In the case buildings, it was noticed that the qualification of HVAC supervisors is not necessarily sufficient to supervise the implementation of complex hybrid heating systems.

Regarding the case buildings' hybrid heating systems, the commissioning process was performed in different ways. There did not seem to be a clear uniform commissioning method between the case buildings. The methodology of the implemented commissioning process is very much dependent on the persons involved in the hybrid heating system project. Some of the case buildings, where a hybrid heating system

project group was implemented already in the project predesign phase, worked exemplary. When the overall responsibilities of the involved persons had been defined, the commissioning process had been carried out with higher quality.

In three case buildings analyzed, the implementation of the hybrid heating system was subcontracted in the building construction project, and the commissioning process was mainly the responsibility of the general HVAC supervisor, who was also the supervisor of another HVAC system. In one case building where hybrid heating system implementation was carried out by the HVAC supervisor, many problems were found in the operational tests. Problems generally led to repairs during the warranty period. Deficient commissioning processes were carried out in three case buildings. The professional skills of the people involved in the hybrid heating system commissioning process can be considered to have a direct connection to the commissioning implementation and hybrid heating system operation.

In three case buildings hybrid heating systems worked very well. In all the other five case buildings, problems were found that affected the operation of the system. The most common problems were related to heat collection, automation, or installation errors. The hybrid heating system of all case buildings included at least two or more heat sources. Free cooling either from the geothermal well field or outside air was also implemented in all case buildings. Heat pumps and district

heating were in every case building, and district cooling connection was in four case buildings. The basic principle of each system was to use the heat pump to produce as much basic heating energy as possible and the remaining top-up heating with district heating.

## Discussion / Conclusions

The benefits of the commissioning process starting from the project predesign phase should be made better known to the professionals of the HVAC and building industry. International commissioning guidelines compiled by ASHRAE and REHVA are very comprehensive, but many people working in the field of HVAC technology have probably never heard of these [1,2,5]. For better publicity of the commissioning process in Finland, the commonly used RT instructions [3-4] should be updated with new commissioning process instructions, which are based on international guidelines [1,2,5]. Involving the commissioning provider from the beginning of the project and predesign phase inspections should be added to the Finnish instructions first.

The building owner/investor should also be made to understand that it is worth investing in the hybrid heating system commissioning process. The implementation of the hybrid heating system project is largely in the hands of the end user. The customer must understand the importance of the commissioning process for the hybrid heating system life cycle. Hybrid heating systems are life-cycle investments and thus the

**Table 1.** Description of case buildings.

Case building No.	Building type	Building size	Hybrid heating system model
1	New residential building with grocery store and few business spaces	9 000 m <sup>2</sup>	GSHP with grocery store waste heat and wastewater heat recovery. Free cooling with wells. DH as top up heating and DC as top up cooling.
2	New School building	9 000 m <sup>2</sup>	GSHP with DH. Free cooling with wells.
3	New School building	10 000 m <sup>2</sup>	GSHP with DH. Free cooling with wells.
4	Renovated Apartment building area	29 000 m <sup>2</sup>	GSHP with DH. Free cooling with wells.
5	Shopping centre	100 000 m <sup>2</sup>	HP with grocery store waste heat recovery, exhaust air heat recovery, cooling network waste heat recovery. DH as top up heating.
6	Renovated commercial building	12 500 m <sup>2</sup>	AWHP with booster HP. DH as top up heating.
7	New apartment building with offices and market	14 000 m <sup>2</sup>	HP with DC return connection. DH as top up heating and DC as top up cooling. Area heating and cooling network.
8	Combination of office/education buildings properties	33 000 m <sup>2</sup>	AWHP low temperature area heating and cooling network. DH as top up heating and DC as top up cooling.

correct operation of the system must be guaranteed throughout its life cycle for the savings to be realized. It is senseless to invest in expensive hybrid heating system equipment if all of its possible benefits are not reached. If the hybrid heating system runs only on a backup heat source such as district heating or electricity boilers, the energy costs increase many times over the set targets. Thus, if a hybrid heating system investment is made, its correct operation during the life cycle must be guaranteed, because the payback period of the system is largely based on the energy consumption of the building.

Commissioning process costs are small compared to the savings produced during the life cycle of a large hybrid heating system. Ongoing commissioning and comprehensive monitoring of the hybrid heating systems are very important to verify that energy is produced and used in an optimal way. Ensuring the hybrid heating system operation also supports the maximizing of environmental benefits, when all the environmental and energy-saving potential can be achieved. Therefore, desire and expertise are needed on the customer side right from the beginning of the energy-efficient heating project.

The responsible contractor of the hybrid heating system should be a professional contractor who is responsible for the implementation and operation of the entire hybrid heating system. The contractor should understand the equipment installation and system operation. Hybrid heating system contracts should not be divided into shared contracts. Hybrid heating system projects should be implemented as overall responsibility contracts. Using prefabricated systems has been found to reduce installation mistakes. The flow of information and cooperation between owner/investor, supervisors, equipment manufacturers, designers, and contractors are very important parts of high-performing hybrid heating systems.

The hybrid heating systems can be made to work when the overall responsibilities and the responsibilities of the parties involved in to project are precisely defined. Here are a few ways as an example:

- The project should have a competent commissioning provider who should guide the entire project from predesign to ongoing commissioning.
- One proficient contractor should be responsible for the entire hybrid heating system installation.
- The whole system could be based on a life-cycle responsibility model, in which the property owner buys 'heat as a service' from the hybrid heating system owner/implementer.

Finding a qualified and professional commissioning provider is also a challenge for better commissioning process execution in hybrid heating systems. Currently, there is a lot of demand for experts related to HVAC and building energy efficiency. The commissioning provider should be an experienced specialist in HVAC and automation systems and understand the complete operation of the hybrid heating system equipment. A classification should be developed for evaluating the competence of the commissioning provider. For example, to analyze the commissioning provider's references and experience in similar projects, a competence assessment and testing similar to the ASHRAE training agenda and training evaluation could be done [1-2].

The lack of education and unawareness of the hybrid heating systems are also a big challenge. There is no direct education for HPs and hybrid heating systems at any level. Hence, there are a lot of self-taught people working in the field and the instructions are partly incomplete. It has also been noticed that not all HVAC designers have the required skills to design hybrid heating systems. Education related to hybrid heating systems should be improved and courses about the cooperation of the different heat pumps, additional heat sources, energy recycling, and automation should be organized. ■

### Acknowledgement

This study is funded by TALOTEKNIikka 2030 programme.

### References

- [1] ASHRAE. (2018). *Commissioning Process for Buildings and Systems*, ANSI/ASHRAE/IES Standard 202.
- [2] ASHRAE. (2019). *The Commissioning Process, ASHRAE Guideline 0*.
- [3] Finnish Building Information Foundation RTS. (2018). *RT 10-11301, Talotekniikan laadunvarmistus- ja vastaanottomenettely*.
- [4] Finnish Building Information Foundation RTS. (2018). *RT 10-11302, Talotekniikan laadunvarmistus- ja vastaanottomenettely, tehtävät ja dokumentointi*.
- [5] REHVA. (2019). REHVA Guidebook No. 27 - HVAC Commissioning Process.



# Scaling Machine Learning for building operational phase



**DAVOR STJELJA**

AI Lead, Granlund Oy, Finland  
PhD student, Aalto University, Finland  
davor.stjelja@aalto.fi

Machine learning in building management faces challenges due to the unique characteristics of each building, hindering broad applicability and scalability. The field is evolving to address these challenges by leveraging explicit and cognitive knowledge: explicit for structured problem-solving like HVAC troubleshooting through knowledge graphs, and cognitive for understanding complex interactions through historical data analysis. Key issues include the necessity for building-specific models, ensuring model robustness, and bridging professional trust gaps. Innovative approaches like transfer learning, which involves training models on extensive data from one building and fine-tuning with data from another, and probabilistic predictions, which account for uncertainty, are showing promise. These strategies are enhancing the adaptability, scalability, and trustworthiness of machine learning solutions in building management, marking significant progress in the field.

**Keywords:** Scaling Machine Learning, Smart Buildings, AI for building management, knowledge graphs.

## Machine Learning for effective building management

The European Union's Smart Readiness Index is at the forefront of promoting this digital shift. However, this move towards digitalization generates vast amounts of data, which can be overwhelming for manual processing.

In this scenario, cutting-edge technologies such as Artificial Intelligence (AI) and Machine Learning (ML) emerge as vital tools. They have the capability to efficiently process and interpret large data sets, playing a crucial role in the reduction of carbon emissions.

Building data is available in multiple layers of detail. At the macro level, we can track overall energy consumption. On a more detailed scale, we can examine data from specific subsystems like heating, cooling, and ventilation. Going even further, it's possible to monitor particular settings and metrics within these subsystems. Additionally, factoring in variables related to building occupants – such as their schedules, count, satisfaction, and comfort levels – alongside facility management aspects like maintenance schedules and costs, gives us a more complete picture of a building's operations. Navigating through this extensive array of data can be daunting. This is precisely where AI and ML prove to be indispensable. They enable us to make sense of and effectively utilize this vast amount of information.

## Challenges of wider usage of ML

A lot of the existing research is quite localized and narrow in scope, often with researchers focusing on data from their own institutions, such as universities or campuses (Miller, 2019). In these environments, they develop and test algorithms. The major drawback of this approach is its limited external validation: these solutions aren't extensively tested across various types of buildings. This lack of diverse application testing restricts the broader implementation of machine learning in optimizing building efficiency. As a result, the potential of machine learning in this field is not fully realized, underlining the need for more generalized and widely applicable research.

The distinct characteristics of each building pose a substantial challenge to the scalability of machine learning solutions in this domain. Buildings differ significantly in aspects such as their geographic location, physical properties, technical systems, control logic, and patterns of use. For example, a building's location affects its exposure to specific climate and weather conditions. Its technical systems can vary widely in terms of age and functionality, and the control logic

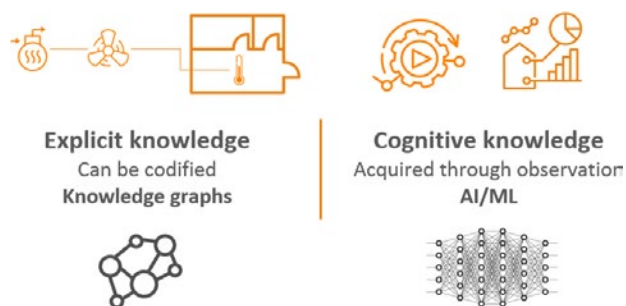
implemented might be unique to that building. Moreover, even buildings that are physically identical can have vastly different usage patterns. Consequently, a machine learning model trained on the data from one building may not perform well when applied to another. This inability to generalize effectively across different buildings is a major obstacle to scaling machine learning solutions in building management.

## Two knowledge types in the built environment

Addressing the challenges in scaling machine learning for buildings can be approached by harnessing the two primary types of knowledge in the built environment: explicit and cognitive, as depicted in **Figure 1**. Explicit knowledge is programmable, meaning it can be systematically codified and queried. For example, consider a scenario where a room is overly warm. You can follow a set of programmable links to pinpoint the issue: the thermometer in Room X connects to a specific ventilation system, which in turn is linked to a particular heating coil. This chain of ‘cause-and-effect’ is programmable and can be directly queried.

In contrast, cognitive knowledge emerges from observation and experience. It involves understanding complex interactions, like how room temperature varies with different heating levels, a task complicated by the multitude of influencing parameters. Machine learning excels here by learning the dynamics of a room from historical data. This process of learning and analysis helps in making accurate predictions, performing classifications, and conducting further analyses, thus enabling a deeper understanding of the more subtle and intricate aspects of building management.

Indeed, explicit knowledge in building management can be effectively captured and utilized through knowledge graphs. A knowledge graph is essentially a structured way of organizing information, enabling a computer to understand and interpret the relationships



**Figure 1.** Illustration of two knowledge types in the built environment: Explicit and Cognitive knowledge.

and connections between various data points or entities. In the context of building management, this becomes a powerful tool to transform intricate HVAC schematics into clear, comprehensible data structures that computers can work with.

For example, in **Figure 2** example is shown from paper by Kukkonen et al (Kukkonen et al., 2022). these graphs can illustrate the relationships between different components in a building, such as which terminals are connected to pump. This structured format of information can then be readily queried for a variety of applications. If there’s an issue with the heating system, for instance, specific prechecks can be programmed or machine learning-based queries can be utilized. The computer, using the knowledge graph much like a database, can then provide insightful answers. Knowledge graphs thus transform complex building systems into accessible and actionable data. This not only simplifies the process of troubleshooting but also enhances overall management efficiency, making the system more responsive and intelligent.

Cognitive knowledge in the context of building management is well-suited for characterization through machine learning. However, applying machine learning at scale in the built environment is fraught with challenges. Firstly, the typical approach of building unique models for each building is resource-intensive. It requires extensive manual data collection and individual model setup, leading to significant costs. Secondly, there’s the challenge of model robustness. Often, models developed for one specific context may not perform effectively when applied in a slightly different environment. This limitation can severely restrict their practical utility. Thirdly, there is a notable trust gap, especially among building professionals who may not be familiar with machine learning. The complexity and sometimes perceived opacity of these models can lead to skepticism regarding their predictions and overall reliability. Finally, the dynamic nature of buildings presents a significant hurdle. Buildings undergo continuous changes — retrofits, upgrades, or shifts in usage patterns. As a result, a model trained on historical data may quickly become outdated or inaccurate, failing to adapt to new circumstances.

## Potential solutions for scaling Machine Learning

These challenges highlight the pressing need for more adaptable, robust, and transparent ML solutions in the built environment. Such solutions should not only be technically proficient but also accessible and

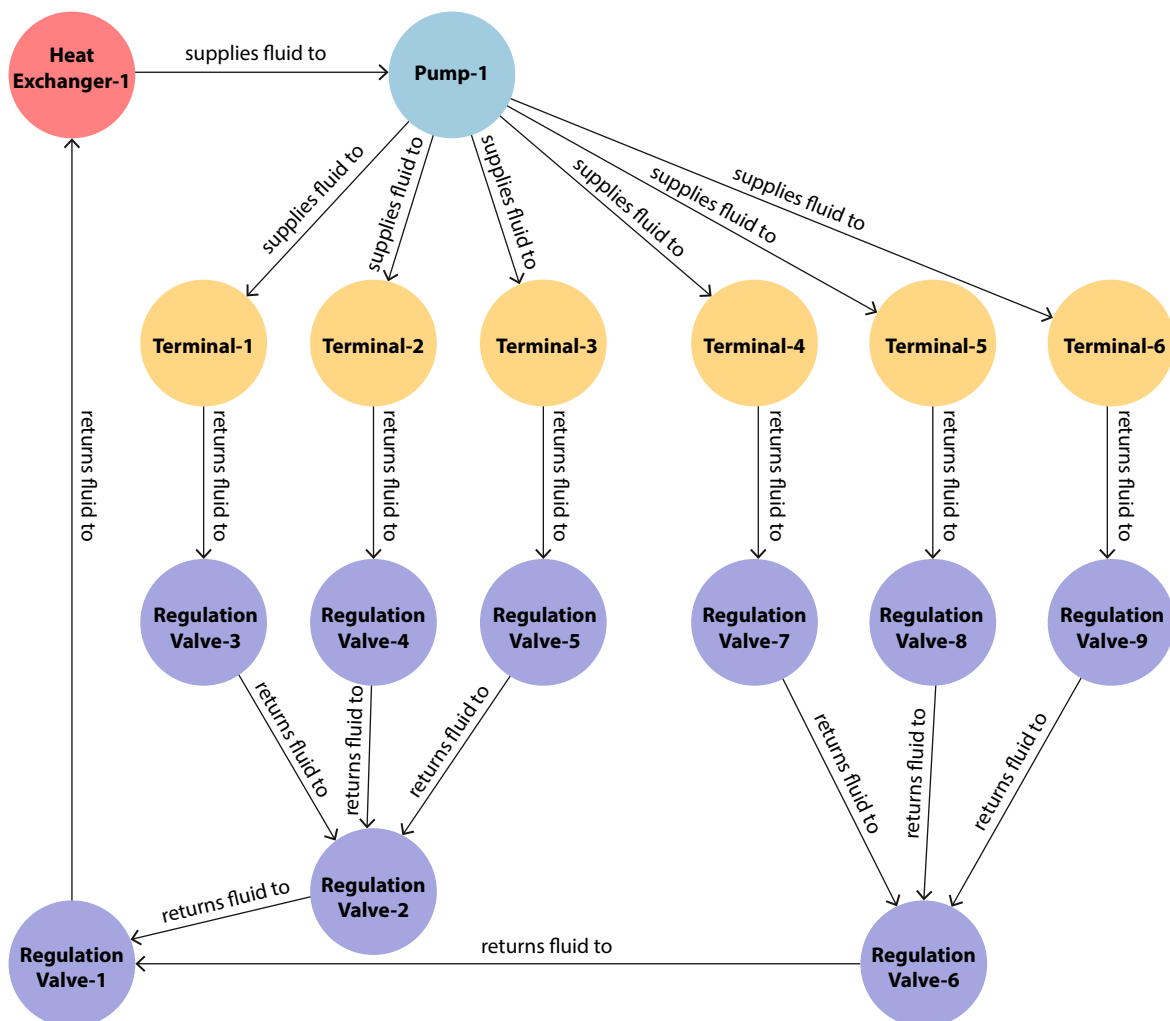
understandable to professionals in the field, ensuring their wider acceptance and effective integration into building management practices.

The exploration of transfer learning as a solution for scaling ML in the built environment is indeed a significant stride in this field. Transfer learning offers a practical and efficient way to apply machine learning models across different buildings, overcoming some of the key challenges associated with building-specific model development. The concept of utilizing a pre-trained model on a new building is particularly noteworthy. By training a model extensively on one building where there is a wealth of data, and then fine-tuning it with a smaller data set from a new building. This method not only saves time but also makes the process more scalable and feasible across various building types and environments.

We have worked on predicting room occupancy with transfer learning method, where I trained a model initially on a meeting room with abundant occupancy data, and then fine-tuning it with limited data from a

room in a completely different building, which showed promising results (Stjelja et al., 2022). The fact that the model performed satisfactorily despite significant differences in building size and HVAC systems is particularly promising. It underscores the potential of transfer learning to revolutionize the application of ML in the built environment, making it more scalable, efficient, and adaptable to varying building dynamics. This approach could indeed be a game-changer in enhancing the application of ML for building management and energy efficiency.

Another promising avenue for scaling ML in building applications is the use of probabilistic predictions, a method we explore in depth in my research (Stjelja et al., n.d.). This approach enhances model robustness and bolsters user confidence in AI systems. Adopting probabilistic predictions moves beyond the limitations of single-point forecasting by embracing a methodology that inherently accounts for uncertainty. The concept of estimating an entire distribution, rather than a single outcome, brings a critical dimension of realism and practicality to ML models. By incorporating uncertainty



**Figure 2.** Example of knowledge graph showing fluid flow from heat exchanger through a pump to radiators. Kukkonen et al.

quantification, these models not only provide predictions but also communicate the confidence level or potential variability in these predictions, potentially bridging the gap in trust and confidence among professionals skeptical of ML's black-box nature. This aspect is particularly valuable in complex systems like buildings, where numerous variables and unpredictable factors come into play. In this paper we compare two approaches of predicting building energy consumption between two probabilistic algorithms. Furthermore, these predictions are then used for the detection of drift anomalies. The proposed method doesn't alert to immediate issues but alerts of emerging trends or irregularities that could become problematic if unaddressed.

### Promising directions

The identified areas of research present promising directions for future investigations aimed at enhancing the scalability of machine learning for building operations. Each area offers distinct solutions and perspectives that could considerably propel the field forward.

- **Continual Learning:** This area focuses on the dynamic aspect of machine learning models, particularly their ability to adapt continually as buildings evolve. This is crucial in the context of buildings, which undergo regular changes in structure, usage, or systems. Continual learning ensures that machine learning models remain relevant and accurate over time, adjusting to new data and conditions. Example is this large-scale comparison and demonstration of continual learning in building operation (Li et al., 2023).
- **Explainable AI (XAI):** The field of Explainable AI is gaining traction, particularly for its potential to demystify the decision-making processes of AI models. By making AI predictions more transparent and understandable, XAI could greatly enhance trust and confidence among building management professionals. This is particularly important for those who might be hesitant to rely on AI due to its perceived opacity. This review paper shows state of the art research on XAI topic in this field (Chen et al., 2023).
- **Few-Shot Learning:** This approach is particularly relevant for situations where data is scarce, such as in new or recently retrofitted buildings. Few-shot learning allows for the training of effective machine learning models using minimal data points, which is a significant advantage in scenarios where extensive historical data is not available. Interesting paper using few-shot building energy prediction is (Tang et al., 2023).
- **Transfer Learning:** For a comprehensive understanding of transfer learning in building management, review paper by Pinto et al. could be a valuable resource (Pinto et al., 2022). Transfer learning, as highlighted, can address the issues of scalability and data requirement in deploying machine learning models across different buildings.

These research areas collectively represent the forefront of AI and ML in building management. They offer promising solutions to overcome current challenges and pave the way for more efficient, adaptable, and trustworthy AI applications in this domain. For professionals and researchers interested in this field, delving into these topics would provide a deeper understanding of the potential and direction of AI in the built environment. ■

### References

- Chen, Z., Xiao, F., Guo, F., & Yan, J. (2023). Interpretable machine learning for building energy management: A state-of-the-art review. *Advances in Applied Energy*, 9, 100123. <https://doi.org/10.1016/j.adapen.2023.100123>.
- Kukkonen, V., Kückükavci, A., Seidenschur, M., Rasmussen, M. H., Smith, K. M., & Hviid, C. A. (2022). An ontology to support flow system descriptions from design to operation of buildings. *Automation in Construction*, 134, 104067. <https://doi.org/10.1016/j.autcon.2021.104067>.
- Li, A., Zhang, C., Xiao, F., Fan, C., Deng, Y., & Wang, D. (2023). Large-scale comparison and demonstration of continual learning for adaptive data-driven building energy prediction. *Applied Energy*, 347, 121481. <https://doi.org/10.1016/j.apenergy.2023.121481>.
- Miller, C. (2019). More Buildings Make More Generalizable Models—Benchmarking Prediction Methods on Open Electrical Meter Data. *Machine Learning and Knowledge Extraction*, 1(3), Article 3. <https://doi.org/10.3390/make1030056>.
- Pinto, G., Wang, Z., Roy, A., Hong, T., & Capozzoli, A. (2022). Transfer learning for smart buildings: A critical review of algorithms, applications, and future perspectives. *Advances in Applied Energy*, 5, 100084. <https://doi.org/10.1016/j.adapen.2022.100084>.
- Stjelja, D., Jokisalo, J., & Kosonen, R. (2022). Scalable Room Occupancy Prediction with Deep Transfer Learning Using Indoor Climate Sensor. *Energies*, 15(6), 2078. <https://doi.org/10.3390/en15062078>.
- Stjelja, D., Kuzmanovski, V., Kosonen, R., & Jokisalo, J. (n.d.). Building consumption anomaly detection: A comparative study of two probabilistic approaches. *Submitted to Energy & Buildings*.
- Tang, L., Xie, H., Wang, X., & Bie, Z. (2023). Privacy-preserving knowledge sharing for few-shot building energy prediction: A federated learning approach. *Applied Energy*, 337, 120860. <https://doi.org/10.1016/j.apenergy.2023.120860>.



## AICVF conference: Attractiveness of HVAC professions for young people and feminization

On January 11th, AICVF held its first highlight of the year in Paris. 70 participants attended this event dedicated to the theme “Attractiveness of HVAC professions for young people and feminization of the profession.” The event was organized around two panel discussions titled “Making our professions more attractive to new generations” and “Supporting the feminization of our professions”.

The first panel discussion was introduced by a presentation describing the training of higher-level technicians (IUT Poitiers). It was completed by the training of engineers (Insa Strasbourg). Finally, the development for employment and skills to support the industry in energy transition was presented (GRDF). All presenters agreed that the HVAC professions remain unknown to young people and that the theme of energy is little identified by high school students. Several actions have been put in place to compensate for this: organization of career and qualification meetings, awareness of climate change issues, etc.

During the second round table the obstacles regarding the feminization of HVAC professions were discussed (Schneider & Cie company). Then, the group’s actions in favour of diversity and the “WE Do for Tech” program were detailed (OFIS, Veolia). Several experiences were shared (TRIBU Energy, Women in Building Club). SMEs and large groups are taking

voluntary steps to increase the number of women in their workforce. The Veolia group, for example, initiated the “Wedo for tech” program which consists of organizing meetings between young girls and employees during an observation day.

The president of AICVF, Frank Hovorka, concluded this event by expressing his pride in seeing the theme of feminization addressed without taboo. “It is necessary to continue this approach to diversity, which seems fundamental,” he added.

Then, Frank Hovorka presented his wishes. 2024 is expected to be complex as HVAC professions are likely to face a crisis of reduced activity. However, he wanted to be reassuring: “We will face it together. It is precisely the time to invest in training, human resources, and skills to prepare for the medium term. Every crisis has an end, and it is important to project ourselves now towards the end of this difficult period.” ■

# REHVA supports actively Heat pump standardisation at European Level

Heat pumps will play a major role for the EU energy transition. European funding will support their rollout. The performance assessment of heat pumps should reflect the real impact on energy efficiency and climate change, be transparent, harmonised in order to create an EU level playing and to avoid the fragmentation of the EU heat pump market. Having a common method, with reliable results, is in the interest of industrials, professionals, building owners and consumers.

The assessment must take into account the heat pump product characteristics (data supplied by manufacturers) and the heating system running conditions (e.g. sizing, temperature conditions). It must be accurate, reliable and easy to realise. The European standard EN 15316-4-2 “Heat pump systems” is used to calculate the energy performance of heat pumps in the context of the Directive on the Energy Performance of Buildings (EPBD). This standard is being revised.

To be able to do the revision in short time, it was decided to establish a task group under the lead of CEN TC 228 “Heating systems in buildings”. **Johann Zirngibl**, convener of CEN TC 228/WG4, invited experts from:

- the product side (CEN TC 113 “Heat pumps and air conditioning units”, industrial);
- the heating system side (CEN TC228 “Heating systems in buildings”);

- the cooling side (CEN TC 156 “Ventilation for building”);
- other key stakeholder (national experts, consumer and professional organisations, energy suppliers, etc);

to the kick-off meeting which was held the 15th of January 2024 in the AFNOR premises in Paris. Around 30 experts from 14 European Countries followed the invitation.

REHVA members **Catalin Lungu** (REHVA president), **Jarek Kurnitski** (Chair of REHVA Technology and Research Committee TRC) and **Jaap Hogeling** (Editor in Chief REHVA journal) attended the meeting. In addition to their own professional experience, they brought in also the REHVA expertise and views. The content of these meetings will be disseminated through REHVA’s communication channels and the REHVA spin-off dedicated to standardisation, the EPB center (<https://epb.center/>). ■



Participants of the Heat pump meeting in Paris.



REHVA members attending the Heat pump meeting.

# LG's "Care For Where You Live: New Horizon" Campaign: Paving The Way For Eco-Friendly Filmmaking

An Eco-Conscious Cinematic Journey Showcasing LG's THERMA V Air-to-Water Heat Pump.

LG Electronics is delighted to unveil the "Care For Where You Live: New Horizon" campaign, a cinematic endeavor dedicated to showcasing the THERMA V air-to-water heat pump. Recently certified with a remarkable 2 stars by the Ecoprod Label, this campaign stands as a pioneering effort in sustainable and eco-conscious filmmaking.

From concept to execution, the "Care For Where You Live: New Horizon" campaign places sustainability at the forefront, seamlessly integrating eco-friendly practices into every aspect of the filmmaking process. Director Tom Bartowicz explains, "We wanted to tell a sincere story, full of emotion, in tune with the times. That's why we've subtly integrated everyday eco-gestures into the behavior of our characters."

Guided by a strategic roadmap, the eco-production journey of "Care For Where You Live: New Horizon" prioritized meticulous pre-production logistics, sustainable location choices, and the promotion of local talent. To tackle waste management challenges, the campaign implemented proactive measures, such as the ban on single-use items, promotion of reusable materials, and a comprehensive waste reduction strategy during the shoot.

The campaign achieved outstanding results in terms of sustainable filmmaking, positioning itself as an exemplary model for the industry. Participating in the pilot phase of the Ecoprod Label, "Care For Where You Live: New Horizon" has also contributed to refining the label as a relevant and effective tool for sustainable filmmaking practices.

## Key Achievements:

- **CO<sub>2</sub> Emission Reduction:** The campaign achieved a remarkable 78.5% validation in the eco-production score, resulting in substantial carbon emission savings.
- **Water Conservation:** 2000 liters of drinking water were saved during the shoot.
- **Waste Management:** 90% of waste was returned, reused, recycled, or composted.

Daria Plotkina, European Communications Specialist, B2B Air Solution at LG Electronics, reflects on the campaign, stating, "Our 'New Horizon' campaign was an opportunity for us to introduce new marketing practices based on the eco-production approach. A different, responsible way of working, totally in line with our corporate values and proving that we all have the power to act."

LG's unwavering commitment to responsible production establishes a new standard for the sector, showcasing the company's dedication to sustainable and environmentally-friendly filmmaking practices. With its exceptional score, the "New Horizon" campaign proudly secures a 2-star certification from the Ecoprod Label, solidifying its status as a standout example of eco-friendly filmmaking.

## Eco-production partners

- **Eco-Referent:** Provided a strategic action plan to limit environmental impacts, while also raising awareness among the team regarding eco-production issues.
- **Ateo:** Specialized in footprint calculation and analysis, offering essential insights into environmental impact assessment.
- **A Better Prod:** Played a crucial role by conducting impact analysis, creating summary reports, and providing support in the certification process. They coordinated data collection for the carbon footprint and supporting documents.
- **Big Mama:** Focused on eco-creative communication, helping to convey the campaign's environmentally conscious message effectively.
- **Agroof:** A consulting firm with expertise in the study and development of agroforestry systems, contributed significantly to the project's environmental contributions and sustainability initiatives.

## Calculation tools

### *The Bilan Carbone® carbon balance: This method of accounting for greenhouse gases*

(GHG) is widely used in France. Developed by the French Environment and Energy Management Agency (ADEME - Agence française de la transition écologique), it identifies the main emission sources for an activity, with the aim of implementing actions to reduce the overall environmental footprint (according to the GHG emissions reduction trajectory set by the Paris Agreement at COP 21). Bilan Carbone® is calculated in tons of CO<sub>2</sub> equivalent.

### *The Carbon'Clap calculator*

The tool is dedicated to measuring the specific GHG emissions associated with audiovisual production. It was drawn up by the Ecoprod association, in partnership with ADEME. It identifies the most emitting items in order to guide choices and strategies for avoiding or reducing greenhouse gas emissions.



## For more information:

The Ecoprod association:  
<https://www.ecoprod.com/en>

ADEME's advice on responsible communication:  
<https://communication-responsable.ademe.fr>

# Exhibitions, Conferences and Seminars

Please send information of your event to Ms Marie Joannes [mj@rehva.eu](mailto:mj@rehva.eu)

## March 2024

3-8 March 2024	Light+Building 2024 ( <a href="http://light-building.messefrankfurt.com">light-building.messefrankfurt.com</a> )	Frankfurt, Germany
5-8 March 2024	WSED ( <a href="http://wsed.at">wsed.at</a> )	Wels, Austria
12-13 March 2024	53rd AiCARR International Conference ( <a href="http://aicarr.org">aicarr.org</a> )	Milan, Italy
12-15 March 2024	MCE 2024 ( <a href="http://mcexpocomfort.it">mcexpocomfort.it</a> )	Milan, Italy

## April 2024

22-25 April 2024	Roomvent 2024 ( <a href="http://nvitepeople.com">nvitepeople.com</a> )	Stockholm, Sweden
------------------	--	-------------------

## May 2024

15-17 May 2024	REHVA Annual meeting 2024 ( <a href="http://rehva.eu">rehva.eu</a> )	Istanbul, Turkey
18-19 May 2024	AICVF/ASC Conference ( <a href="http://aivc.org">aivc.org</a> )	Singapore

## June 2024

9-11 June 2024	BuildSim Nordic 2024 ( <a href="http://ibpsa-nordic.org">ibpsa-nordic.org</a> )	Espoo, Finland
10-14 June 2024	CISM "Ventilation, health and well-being" summer courses ( <a href="http://cism.it">cism.it</a> )	CISM - Udine, Italy
22-26 June 2024	ASHRAE Annual Conference ( <a href="http://ashrae.org">ashrae.org</a> )	Indianapolis, USA

## July 2024

25-27 July 2024	IBPC 2024 ( <a href="http://ibpc2024.org">ibpc2024.org</a> )	Toronto, Canada
-----------------	--	-----------------

## October 2024

9-10 October 2024	AIVC ( <a href="http://aivc.org">aivc.org</a> )	Dublin, Ireland
-------------------	---	-----------------

## June 2025

4-6 June 2025	CLIMA 2025 ( <a href="http://climaworldcongress.org">climaworldcongress.org</a> )	Milano, Italy
---------------	---	---------------





# The 43rd MCE - Mostra Convegno Expocomfort

*A new commitment by RX Italy for new proposals in the HVAC+R sector*

**MCE – Mostra Convegno Expocomfort, the world’s leading biennial exhibition in civil and industrial plant engineering, air conditioning and renewable energies, returns to its usual winter schedule from 12 to 15 March 2024 at Fiera Milano. The 43rd edition has been vigorously renewed and is full of new formats, from introducing competitions and prizes to new opportunities for exhibitors, in line with RX Italy’s vision, positioning, and direct commitment.**

**M**CE - Mostra Convegno Expocomfort (mceexpocomfort.it), the most prestigious showcase and the global business platform for companies in the HVAC+R, renewable energy and energy efficiency industries, is for the first time presenting its new offer to create business opportunities, strong in the claim “**Beyond Comfort**” and its declination in the three main pillars of all MCE’s activities: Innovation, Sustainability and Energy Efficiency.

With this in mind, the upcoming edition will add value to the critical showcase of products and solutions through the development of special focuses to guide professionals in their choice of the best solutions. **Industrial, Smartness and Hydrogen**, characterised by dedicated events and visitors’ pathways to contextualise and rationalise the wide range of products on display, highlighting the newest and most specific components of some particular areas.

“The recent agreement with ENEA has made MCE the Opinion Leader of Italia in Classe A, the national information and training programme on energy efficiency. It is only the latest step in a long journey towards the event, with initiatives designed to involve all the professional categories called upon to make the difference in tomorrow’s plant engineering,” emphasises Massimiliano Pierini, Managing Director of RX Italy Srl, “and aimed at going beyond comfort living by broadening the target audience for energy efficiency actions.”

MCE confirms itself as an unmissable appointment to build relationships and forge strategic alliances. According to the latest figures, 90% of the exhibition spaces have already been taken (some are fully booked), and over 1,300 companies have registered. Out of these, 55% are from overseas.

These results were also enhanced by introducing the new layout, which sees the convergence and integration of technologies, the definition of new direct connections and the optimisation of visit pathways.

In order to promote economic growth and consolidation of Italian businesses in foreign markets, a renewed collaboration has been established among ICE - Italian Trade Agency, the Ministry of Foreign Affairs and International Cooperation, and belt, a media campaign aimed at promoting the Made in Italy in support of Italian exports and the internationalisation of the national economy. 120 selected foreign professionals from 43 countries worldwide are expected to attend the show for B2B meetings with exhibiting companies.

MCE 2024 is currently witnessing the introduction of new proposals aimed at all professionals involved in the design, distribution, and installation of HVAC+R systems. The “Efficiency and Innovation Path” is undergoing transformation, with the institution of new awards called the **MCE Excellence Awards - Efficiency&Innovation 4 Transition Goals**. These awards will be given to components, systems, and technologies

that help accelerate the energy and environmental transition in line with commitments made as part of the United Nations 2030 Agenda signed in 2015.

The 43rd edition of MCE also marks the launch of the Water Prix, promoted in collaboration with Aqua Italia and ANGAISA, on the issue of Intelligent (use of) water, a competition with prizes that communicates the value of water and creates engagement between visitor and exhibitor. Up for grabs, every day are *instant wins* smartphones, wireless headphones, Amazon vouchers and the final draw of a weekend in a Bandiera Blu resort, recognised as the most environmentally friendly for water, services and sustainability.

The programme of conventions, workshops and events to deepen the themes and growth potential of specific areas is always rich and engaging, with the presentation of the **10th CRESME Report on civil and industrial plant engineering industry**, institutional speeches and those organised by international associations (EHPA - European Heat Pump Association and REHVA - Federation of European Heating, Ventilation and Air Conditioning Associations in the first place). Partner associations also join in, with AICARR leading the 53rd International Convention and the presentation of CLIMA 2025.

“Beyond Comfort shows that we take our new claim and the call for sustainability seriously at RX - concludes Pierini. - We believe it’s our responsibility to lead the way in the decarbonisation of the events industry. We are committed to achieving net zero carbon emissions across our company, events, and industry by being a founding member of the Net Zero Carbon Events Pledge. We are committed to achieving net zero emissions by 2040 and a 50% reduction by 2030. Given the complexity of our supply chain and the emissions associated with running a trade show, it is only by working together as an industry that we can ensure a more sustainable future. To ensure the achievement of this critical objective, MCE is designed and implemented in compliance with ISO 20121:2013 Certification for Sustainable Organisation of Trade Shows/Events.”

MCE - MOSTRA CONVEGNO EXPOCOMFORT is an exhibition owned by RX, a company dedicated to generate business for individuals, communities and organisations. WE elevate the power of face-to-face events by combining data and digital products to help customers learn about markets, individual products, and close business deals at approximately 400 events in 22 countries, serving 42 industry sectors. RX is committed to positively impacting society and is fully dedicated to creating an inclusive working environment for all.

RX is part of RELX, a global provider of information-based analytics and decision tools for professional and business customers. [www.rxglobal.com](http://www.rxglobal.com)



ATIC vzw—asbl – Belgium  
[www.atic.be](http://www.atic.be)



BAOVK – Bulgaria  
[www.baovk.bg](http://www.baovk.bg)



STP – Czech Republic  
[www.stpcr.cz](http://www.stpcr.cz)



DANVAK – Denmark  
[www.danvak.dk](http://www.danvak.dk)



EKVÜ – Estonia  
[www.ekvy.ee](http://www.ekvy.ee)



FINVAC – Finland  
[www.finvac.org](http://www.finvac.org)



AICVF – France  
[www.aicvf.org](http://www.aicvf.org)



VDI-e.V. – Germany  
[www.vdi.de](http://www.vdi.de)



ÉTÉ – Hungary  
[www.eptud.org](http://www.eptud.org)



MMK – Hungary  
[www.mmk.hu](http://www.mmk.hu)



AICARR – Italy  
[www.aicarr.org](http://www.aicarr.org)



LATVIJAS SILTUMA, GĀZES UN ŪDENS  
 TEHNOLĢIJAS INŽENIERU SAVIENĪBA

AHGWTEL/LATVAC – Latvia  
[www.lsgutis.lv](http://www.lsgutis.lv)



LITES – Lithuania  
[www.listia.lt](http://www.listia.lt)



AIIRM – Republic of Moldova  
[www.aiirm.md](http://www.aiirm.md)



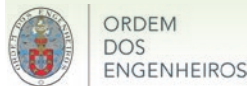
TVVL – The Netherlands  
[www.tvvl.nl](http://www.tvvl.nl)



NEMITEK – Norway  
[www.nemitek.no](http://www.nemitek.no)



PZITS – Poland  
[www.pzits.pl](http://www.pzits.pl)



ORDEM DOS ENGENHEIROS – Portugal  
[www.ordemengenheiros.pt](http://www.ordemengenheiros.pt)



AFCR – Romania  
[www.criofrig.ro](http://www.criofrig.ro)



AGFR – Romania  
[www.agfro.ro](http://www.agfro.ro)



AIIR – Romania  
[www.aiiro.ro](http://www.aiiro.ro)



KGH c/o SMEITS – Serbia  
[www.smeits.rs](http://www.smeits.rs)



SSTP – Slovakia  
[www.sstp.sk](http://www.sstp.sk)



ATECYR – Spain  
[www.atecyr.org](http://www.atecyr.org)



SWEDVAC – Sweden  
[www.emtf.se](http://www.emtf.se)



DIE PLANER – Switzerland  
[www.die-planer.ch](http://www.die-planer.ch)



TTMD – Turkey  
[www.ttmd.org.tr](http://www.ttmd.org.tr)



CIBSE – United Kingdom  
[www.cibse.org](http://www.cibse.org)



Daikin Europe – Belgium  
[www.daikin.eu](http://www.daikin.eu)



EPEE – Belgium  
[www.epeeglobal.org](http://www.epeeglobal.org)



ECI – Belgium  
[copperalliance.org](http://copperalliance.org)



EVIA – Belgium  
[www.evia.eu](http://www.evia.eu)



Velux – Denmark  
[www.velux.com](http://www.velux.com)



Granlund – Finland  
[www.granlund.fi](http://www.granlund.fi)



Halton – Finland  
[www.halton.com](http://www.halton.com)



Uponor – Finland  
[www.uponor.com](http://www.uponor.com)



Eurovent Certita Certification –  
 France  
[www.eurovent-certification.com](http://www.eurovent-certification.com)



LG Electronics – France  
[www.lgeaircon.com](http://www.lgeaircon.com)



Saint-Gobain – France  
[www.saint-gobain.com](http://www.saint-gobain.com)



Viega – Germany  
[www.viega.com](http://www.viega.com)



Aermec – Italy  
[www.aermec.com](http://www.aermec.com)



Rhoss – Italy  
[www.rhoss.com](http://www.rhoss.com)



Royal Haskoning DHV –  
 The Netherlands  
[www.royalhaskoningdhv.com](http://www.royalhaskoningdhv.com)



SMAY – Poland  
[www.smay.eu](http://www.smay.eu)



E.E.B.C. – Romania  
[www.eebc.ro](http://www.eebc.ro)



Dosetimpex – Romania  
[www.dosetimpex.ro](http://www.dosetimpex.ro)



Sunfly Europe – Serbia  
[www.sunflyeurope.com](http://www.sunflyeurope.com)



Camfil – Sweden  
[www.camfil.com](http://www.camfil.com)



Fläkt Group – Sweden  
[www.flaktgroup.com](http://www.flaktgroup.com)



Lindab – Sweden  
[www.lindab.com](http://www.lindab.com)



Swegon – Sweden  
[www.swegon.com](http://www.swegon.com)



Systemair – Sweden  
[www.systemair.com](http://www.systemair.com)



Belimo Automation – Switzerland  
[www.belimo.com](http://www.belimo.com)



Arçelik – Turkey  
[www.arcelikglobal.com](http://www.arcelikglobal.com)



Friterm Termik Cihazlar  
 Sanayi ve Ticaret – Turkey  
[www.friterm.com](http://www.friterm.com)

### REHVA ASSOCIATE ORGANISATIONS:



Airscan – Belgium  
[www.airscan.org](http://www.airscan.org)



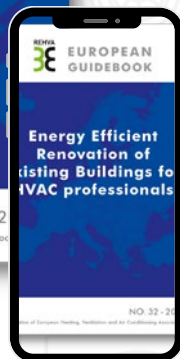
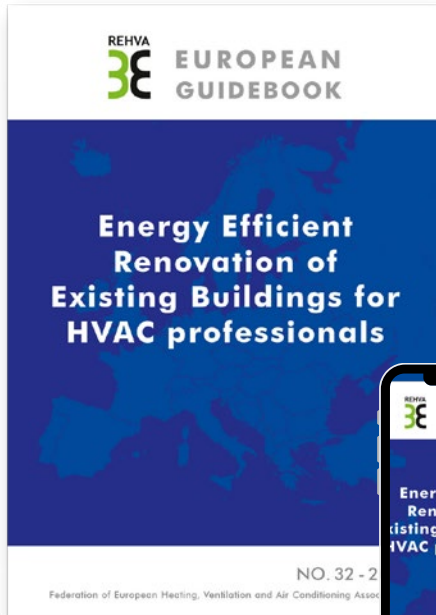
Romanian Chamber of Energy Auditors (OAER)

OAER – Romania  
[www.oaer.ro](http://www.oaer.ro)



ISIB – Turkey  
[www.isib.org.tr](http://www.isib.org.tr)

# Get the latest Guidebook



## Exclusive content!

### Read the first pages of the Guidebook No.32 : Energy Efficient Renovation of Existing Buildings for HVAC professionals

This Guidebook presents the fundamentals for specific energy efficiency and other renovation measures in existing buildings for which HVAC systems play an important role. Emphasis is placed on market-ready and technically mature solutions that have been proven in practice to increase building renovation rates and facilitate the energy renovation process of existing buildings. The Guidebook presents results from field studies with quantified energy savings that are complemented with payback time estimates to document the overall benefits resulting from different renovation measures that can be implemented by HVAC professionals and practitioners.

Read the first pages here!



rehva.eu  
info@rehva.eu