

The **REHVA** European HVAC Journal

Volume: 49

Issue: 2

February 2012

www.rehva.eu

ENERGY EFFICIENT HVAC and EU REGULATIONS

How to improve energy efficiency of fans?

**Ventilation and Energy – maybe not that
irreconcilable**

Effect of EPBD on future ventilation

**Building Integrated System Design for
Sustainable Heating and Cooling**

Phase Change Materials (PCM)

CASE STUDIES:

- **Air-conditioning is not an energy guzzler!**
- **nZEB office building in Finland**

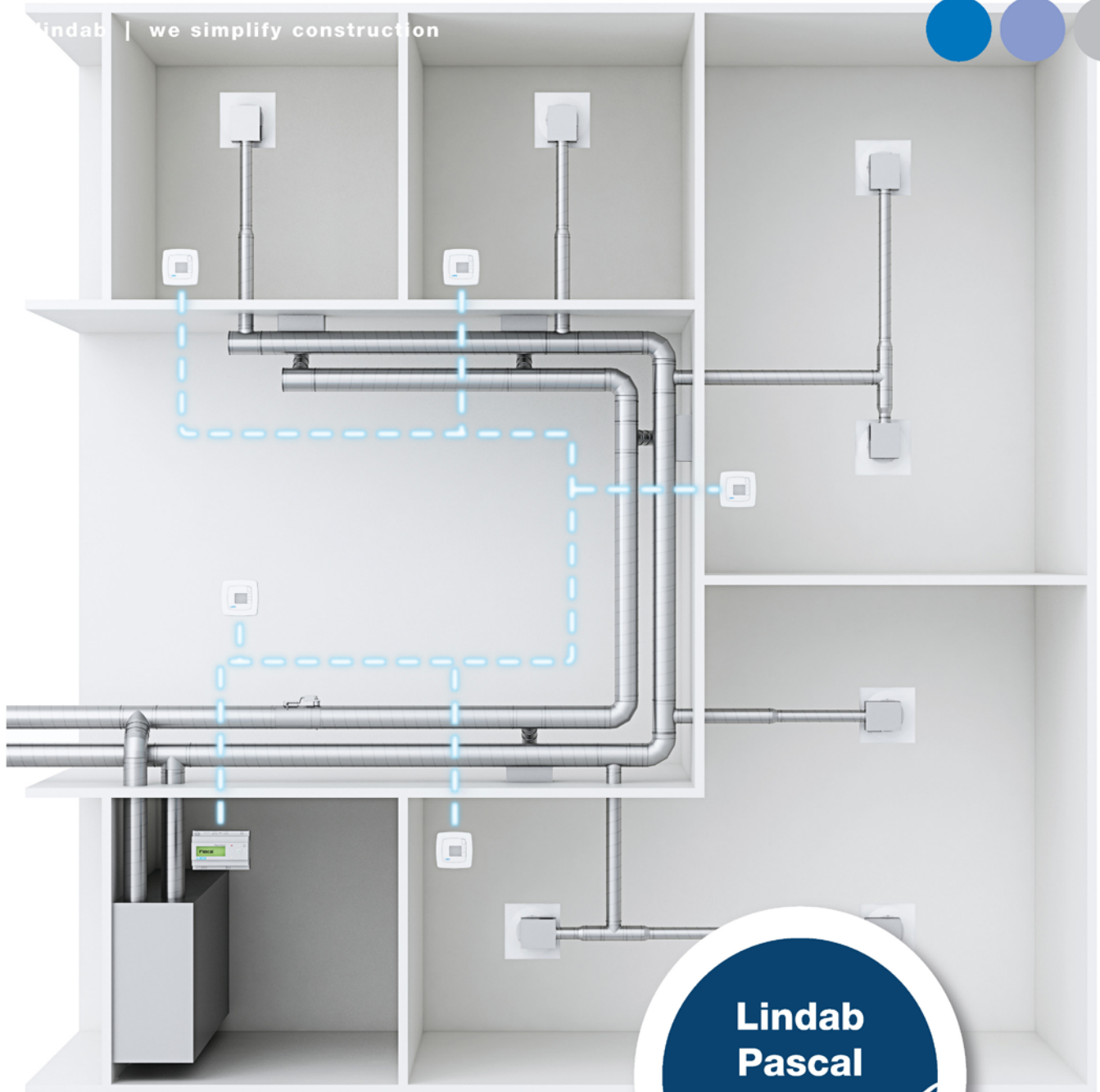

Lindab Pascal

Simplified VAV solution with full potential...

Lindab is now launching the next generation of VAV system with the purpose of simplifying and optimizing all phases of the building construction from design to operation. This solution saves you for unnecessary energy use, regulation equipment in the ducts and a complicated installation. Lindab Pascal, the most simplified solution on the market with all you need for an optimized VAV system.

Lindab - We simplify construction...



The REHVA European HVAC Journal

Volume: 49 Issue: 2 February 2012
www.rehva.eu

REHVA BOARD

President

Michael Schmidt

Vice Presidents

Jan Aufderheijde

Stefano Corgnati

Ioan Silviu Dobosi

Karel Kabele

Zoltán Magyar

Bjarne W. Olesen

EDITORIAL BOARD - 2012

Olli Seppänen, Finland

Francis Allard, France

Ahmet Arısoy, Turkey

Derrick Braham, UK

Marianna Brodatch, Russia

Vincenc Butala, Slovenia

Francesca R. d'Ambrosio, Italy

Ioan Silviu Dobosi, Romania

Signhild Gehlin, Sweden

Jaap Hogeling, the Netherlands

Karel Kabele, Czech Republic

Zoltán Magyar, Hungary

Eduardo Maldonado, Portugal

Livio Mazzarella, Italy

Renato Merati, Italy

Bjarne W. Olesen, Denmark

Dušan Petráš, Slovakia

Michael Schmidt, Germany

Branislav Todorovic, Serbia

Thierry van Steenberghe, Belgium

Maija Virta, Finland

General Executive: Süleyman Bulak

Editor-in-chief: Olli Seppänen

oseppanen@rehva.eu

Guest Editor: Mr. Jorma Railio

E-mail: jorma.railio@gmail.com

ADVERTISEMENTS

Ms Cynthia Despradel
cd@rehva.eu

REHVA OFFICE

Washington Street 40

1050 Brussels, Belgium

Tel: 32-2-5141171, Fax: 32-2-5129062

info@rehva.eu, www.rehva.eu

PUBLISHER

Teknik Yayıncılık Tanıtım A.Ş.

Balmumcu, Barbaros Bulvarı,

Bahar Sok, Karanfil Ap.

Beşiktaş İstanbul Türkiye

Tel: 90-212-2758359

Fax: 90-212-2749273

www.teknikyayincilik.com

REHVA Journal is distributed in over 50 countries through the Member Associations and other institutions. The views expressed in the Journal are not necessarily those of REHVA or its members. REHVA will not be under any liability whatsoever in respect of contributed articles.

Front cover photo: European Parliament by Alina Zienowicz

Contents

EDITORIAL

- 4** Energy efficient HVAC and EU regulations
Jorma Railio

ARTICLES

- 5** How to improve energy efficiency of fans for air handling units
Nejc Brelih
- 12** Ventilation and Energy – maybe not that irreconcilable
Vítor M. S. Leal & Hugo R. R. Santos
- 18** Performance Certification of Refrigerated Display Cabinets (RDC)
Sandrine Marinhas
- 24** Building Integrated System Design for Sustainable Heating and Cooling
Lars Sønderby Nielsen
- 28** Phase change materials
– Energy analysis of a complex heating system with PCM thermal storage in different climatic conditions
Uroš Stritih, Andreja Burkeljca & Vincenc Butala
- 34** Effect of EPBD on future ventilation systems
Olli Seppänen

CASE STUDIES

- 39** Air-conditioning is not an energy guzzler!
D. Nirmal Ram

44 nZEB office building

– Ympäristötalo in Helsinki, Finland

Jarek Kurnitski

PRODUCTS & SYSTEMS

50 INPAL ENERGIE

51 District heating and waste heat

– a combination preventing waste of energy

EU NEWS

52 The new intelligent Energy Europe call for project proposals is open

54 EU regulations

– guidance to REHVA's webpages

Jorma Railio

REHVA WORLD

58 The Russian National Standard on "Green Building" Yury Tabunschikov & Alexander Naumov

62 FINVAC: Summary of activities and collaboration

Siru Lönnqvist

64 EVENTS & FAIRS

Advertisers

- | | |
|------------------------------------|-------------------------------------|
| ✓ Lindab..... Front cover interior | ✓ Hitema 63 |
| ✓ Alfa Laval 11 | ✓ Friterm 65 |
| ✓ Light and Building 17 | ✓ MCE..... Back cover interior |
| ✓ SWEGON 23 | ✓ REHVA Guidebooks Back cover |

In the next issue of REHVA Journal (April 2012)

Theme: **Effect of EPBD on HVAC systems and buildings.**

Articles due: **20 February 2012.**

Guest editor: **Mr Eduardo Maldonado.** E-mail: **ebm@fe.up.pt**

Energy efficient HVAC and EU regulations



JORMA RAILIO
GUEST EDITOR
REHVA FELLOW
Finland
jorma.railio@gmail.com

During the last few years, European legislation related to energy and environmental issues has increased drastically. For example, the number of annually published regulations related to environment is now about three times higher than twenty years ago. This growing trend will continue at least in the near future, and some forecasts indicate that in 2050 we will have ten times more published new EU regulations than in 1990.

Much of this legislation is, directly or indirectly, related to building services and HVAC systems and products. This all means that HVAC professionals must be aware about the new regulations. This is huge “headache” mainly to manufacturers of products, because much of the legislation is targeted to products, or to components and substances in these products. But awareness is also necessary among other stakeholders: system designers, teachers, professional building owners, scientists – actually we all need to get more familiar with the new legislation.

European legislation is a big challenge also to REHVA, who has a very important role to inform HVAC professionals about all new issues affecting our profession and industry. In this mission, REHVA has prepared webpages on EU regulations. These webpages were a result of the initiative from our supporters and opened in May 2011.

These pages can be found at <http://www.rehva.eu/en/eu-regulations> – more about the pages can be found in my article further in this issue.

The main focus of this issue is in air-conditioning systems and products. In different parts of Europe, “air conditioning” can mean many different things. In the EPBD, “air conditioning system” *means a combination of the components required to provide a form of indoor air treatment, by which temperature is controlled or can be lowered.* This definition is interesting and leaves much space for different interpretations. But we must keep in mind that no definition can describe air conditioning so that all system variations in Europe are covered. In cold climates, “air conditioning systems” typically are centralized and include typically ventilation, cooling and also heating. Most systems in Central or South Europe are totally different. And the variety of systems for controlled indoor air is growing all the time.

So, the content of this issue is not restricted to certain types of systems or products, so also contributions looking “out of scope” can also be justified. At least one common feature can be found: the aim towards more energy-efficient technologies, without adverse effects on quality and safety of our indoor environment. Air conditioning should also be studied in a broader perspective: we may talk about products, but our customers – end users – are not really interested in products as they are, but what can be achieved by using these products in buildings and HVAC systems: health, well-being, safety – in other words, quality of life.

How to improve energy efficiency of fans for air handling units



Nejc Brelih
Junior project engineer
REHVA office
nb@rehva.eu

Introduction

Fans use approximately 40% of all electricity in HVAC systems. Despite all the textbooks and handbooks, which describe the proper procedure for selection of fans, practice shows that fans in existing HVAC systems have very low total efficiency. In Sweden, ECiS AB (Energy Concept in Sweden) performed performance measurements of 767 fans in existing HVAC systems between the years 2005 and 2009. The average total efficiency¹ of all the fans was only 33% (**Figure 1**). Only a minor share of the fans had the efficiency in the range 50–60%, which is below the requirements of the EU regulation on efficiency of fans. It is most likely that the data from Sweden represent better than average practice in EU countries. It is evident that on average, fans have a huge energy improvement potential. Up to 50% of electricity for fans could be saved just by designing and installing more energy efficient fans and introducing better control strategies.

Best technology products

Today's best fans include an electric motor in brushless direct current (DC) technology, also known as electronically commutated motors (EC motor), with an integrated frequency converter for step-less load control and an impeller with low aerodynamic losses. Fans should be direct-driven, i.e. the fan impeller is directly mounted on the electric motor shaft. In the range of higher flows and pressures, the EC motors are not yet available. In that range the best available technology of motor is an AC electric motor of the efficiency rating IE3 with a variable frequency drive.

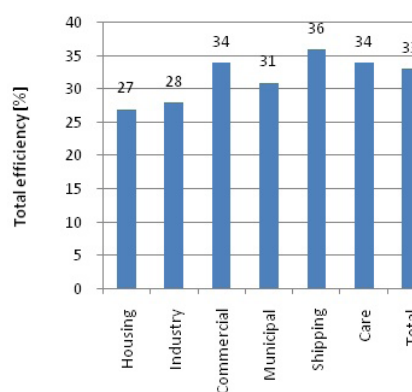
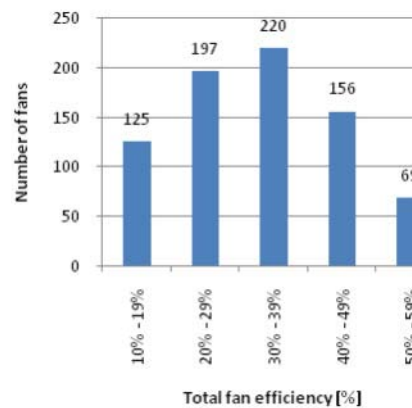

Figure 1. Results of total efficiency measurements of 779 fans in Sweden. Most of the fans had total efficiency between 30–39%. Efficiency is comparable in different building sectors (top), but the lowest in residential sector (bottom).

¹ Total efficiency is measured by comparing the electric power consumption to the mechanical power of the fan.

Requirements for the minimum energy efficiency of fans are presented in the mandatory European regulation on fans based on Ecodesign directive (EC, 2011). The fan regulation (Figure 2) only set limits for the lowest fan efficiency of the products sold or manufactured in EU. Already today in 2012, the products with bet-

ter efficiencies than those required by the directive are available in the market.

According to the regulation on fans, the efficiency of fans must be always given as a total efficiency of the fan assembly, i.e. including losses of all the components of

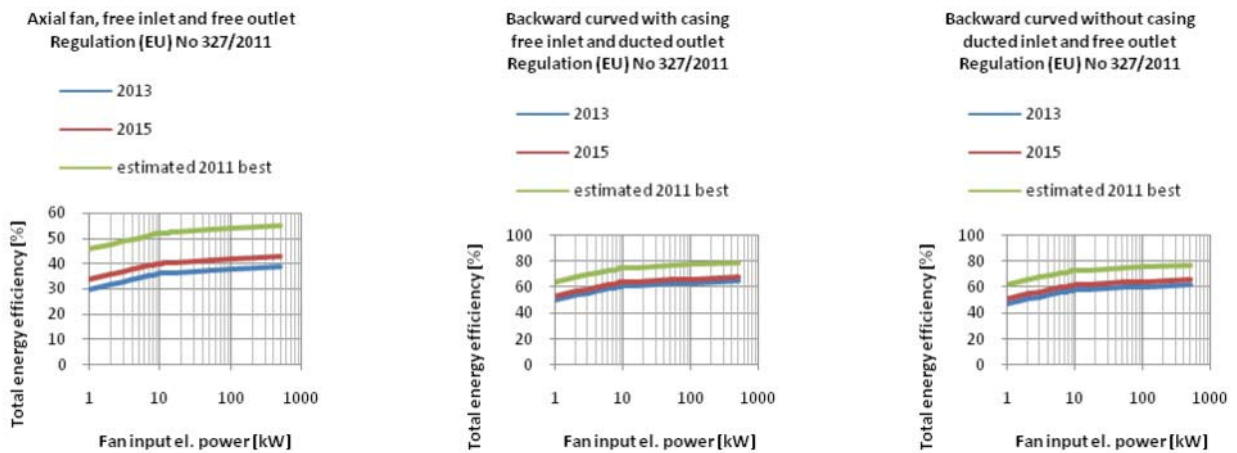

Figure 2. Target total efficiency of fans according to requirements of EU fan regulation. The charts indicate that the requirements for 2015 are stricter than the requirements for 2013.

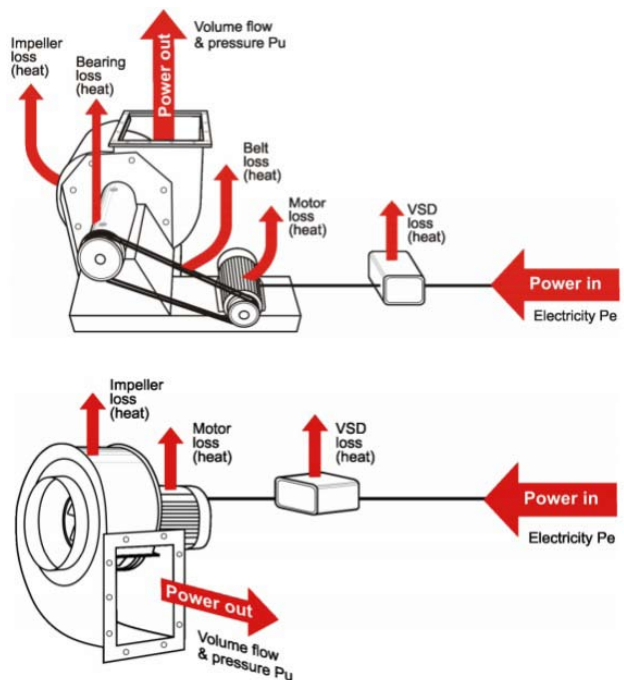
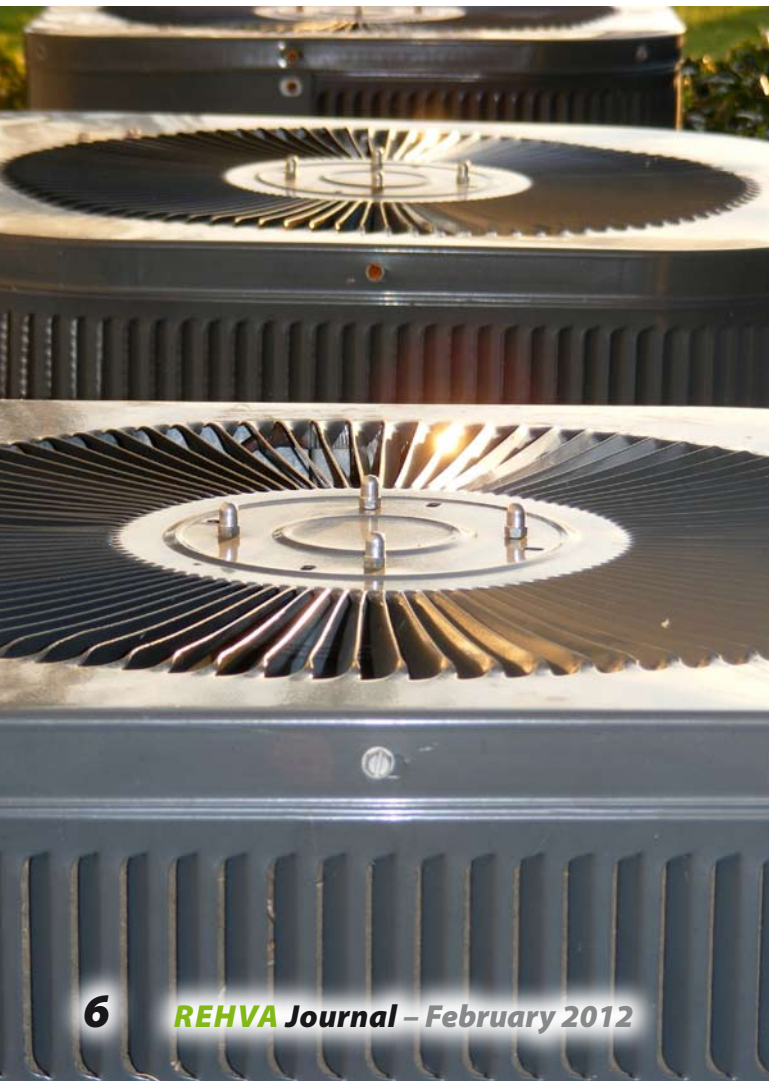

Figure 3. Breakdown of efficiency losses in fans. Belt-driven centrifugal fan (top). Direct-driven centrifugal fan (bottom). There are less steps of energy conversion in direct-driven fans, which makes them more efficient.

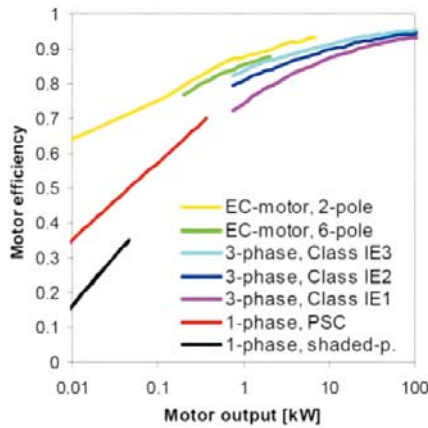

Figure 4. Efficiency of different motor types. EC motors have the highest efficiency, especially in the range of low motor output.

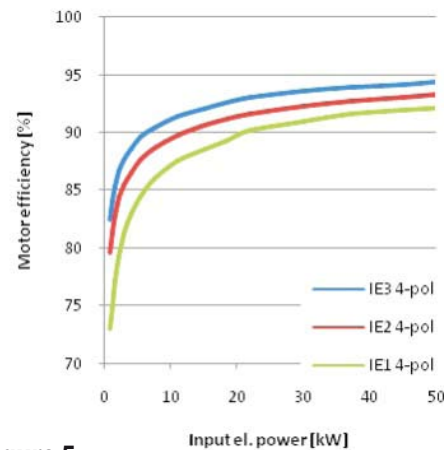

Figure 5. Efficiency classes of AC motors. IE3 class is the most stringent.

the assembly: the electric motor, the frequency converter, the belt drive (if given), the aerodynamic design, and the efficiency of the fan wheel.

The total efficiency is measured by comparing the electric power consumption to the mechanical power of the fan. The total efficiency of a fan is given as a product of all the partial efficiencies of the fan assembly:

$$\eta_{total} = \eta_{motor} \times \eta_{frequency\ converter} \times \eta_{belt\ gear} \times \eta_{dynamic\ loss} \times \eta_{fan\ wheel}$$

It is evident from the equation that in order to have a high total efficiency, all the efficiency of each component should be as high as possible. One weak link in the system can considerably reduce the efficiency of the entire fan assembly.

Motors (η_{motor}) are a crucial link in the efficiency chain of every fan. The best electric motors are brushless DC motors, otherwise known also as the EC motors because they are electronically commutated. The commutation is the application of current to motor phases for production of an optimum motor torque. With an electronic commutation, a motor can operate with e.g. 1.4 poles to find the right speed. The EC motors are currently available in the low power ranges but they are slowly penetrating into the market of the higher motor powers. The advantage of EC motors in comparison to an AC squirrel-cage induction motors is not as outstanding in the high power ranges, but it is the part-load efficiency that gives advantage the EC motor technology (**Figure 4**). The AC motors are classified into the three efficiency classes (**Figure 5**). As from 16th June 2011, motors of the class IE1 should not be sold on the market. Class IE4 (Super-Premium Efficiency) is expected to be

officially defined in the future and will take into account also non-AC motors, like EC motors. The IE3 motors are already available on the market today, and some EC motors already fulfil the requirements of the proposed IE4 class.

Variable frequency drive – VFD ($\eta_{frequency\ converter}$) adjusts the speed of the electric motor according to the load, which results in a lower motor speed and an energy saving. The frequency drive itself has an efficiency rating that needs to be taken into account, because it depends on the nominal output and the partial load. The VFD losses are typically 2...5% at the nominal torque and speed, and 10...30% at 25% torque and speed.

Belt drive ($\eta_{belt\ gear}$) imposes considerable efficiency loss. The efficiency depends on the calculation of the belt gear, type of the belt, and the complete gear adjustment. Normally an expected efficiency of a belt drive is 90% at medium power (3–15 kW), but it can easily slip to 60–70% if the gear adjustment is incorrect. The newly designed AHUs must avoid belt-driven fans and should always use direct driven fans, whose transmission efficiency is 100%.

Aerodynamic design ($\eta_{dynamic\ loss}$). There is always a dynamic pressure loss in a fan. The size of the loss is dictated by the aerodynamics of the fan hood (or the AHU chamber in the case when a hood is not used). A well designed fan hood always gives less dynamic pressure loss than a chamber does.

Fan wheel ($\eta_{fan\ wheel}$). Depending on the type and design of the blades of the wheel, the efficiency will be different. The highest efficiency of up to 85% is achieved with backward curved blades (wheel type B). The forward

type wheel is often used because it delivers greater airflow at smaller sizes of the wheel but at a cost of lower efficiency. In practice, fan wheels with backward curved blades should be used in AHUs.

Selection of a fan type and size

In selecting a fan for HVAC applications it is often found that several fans of different types and sizes provide the required performance. Considering that an engineer already defined the required performance of the fan (airflow requirement, pressure, size restrictions, ambient temperature and other special requirements), the first step in a selection process is to select fan type. If that the fan is to be installed into an AHU, the most common question is whether to select a centrifugal fan in casing or without casing. Centrifugal fan in casing usually has slightly higher efficiency than a fan without casing, but in an AHU it is more vulnerable to the installation effect, which reduces its efficiency. Therefore, for AHUs, a backward curved centrifugal fan without casing is the preferred option for majority of AHUs.

The next step is to select a fan motor. Because of the high efficiency, EC motors should be used whenever possible. Asynchronous AC motors with variable frequency drives as are the second option. When selecting the fan size, several sizes are usually able to provide the required airflow and pressure in the operating point. The size, where the operating point is closest to the best efficiency point and motor electrical input is the lowest, should be selected.

However, if the fan is going to operate in a variable flow system, and it is selected using “worst case” (design) operating point near the point of highest efficiency, such fan may operate at lower efficiency in the part load. Knowing that in variable flow systems fans operate most of the time with less than the “worst case” flow, such a fan will not have the lowest LCC. For variable flow cases, a selection should also consider efficiency and operating time in part-load range. The best efficiency point is by no means close to the 70% of maximum airflow, like suggested in EN 13779, but considerably varies with flow rate and pressure.



Another problem that will probably appear in fans, operating in variable flow but selected for the “worst case” flow is the low frequency noise problem (rumbling), which appears in part load range. This noise is difficult and costly to attenuate. It is better to select a fan size such that peak efficiency is achieved at the most common flow rate, but fan should still be able to deliver the “worst case” flow. During the short periods of maximum flow demand, the increased fan noise will have a higher frequency, which is easier to attenuate, using less expensive silencers.

Importance of good specification

Specification of a fan is an equally important step in a HVAC system design as the selection process. In many EU countries, designers only specify the needed airflow and pressure of a fan in an AHU assembly. The contractor, responsible for ventilation installations, orders equipment on the base of criteria, which is given in the project specification. If total fan efficiency or motor input power is not given in the specification, the contractor can choose any fan that fulfils the basic requirements which are given, i.e. usually airflow and external pressure. In such situation, the contractors select the fan with lowest first cost, which still fulfils the specified requirements. Due to the fact that one fan can cover a wide range of airflows and pressure, especially in combination with a variable frequency drive, it is relatively easy to choose a smaller (and cheaper) fan instead of a larger (and more expensive) fan. **Figure 6** shows how two different fans can operate at the same operating point but one fan has more than 20% lower total efficiency. The fan with the lower efficiency is two nominal sizes smaller and thus less expensive to install than the fan operating with the higher efficiency. The current EU fan regulation does not prevent such situation

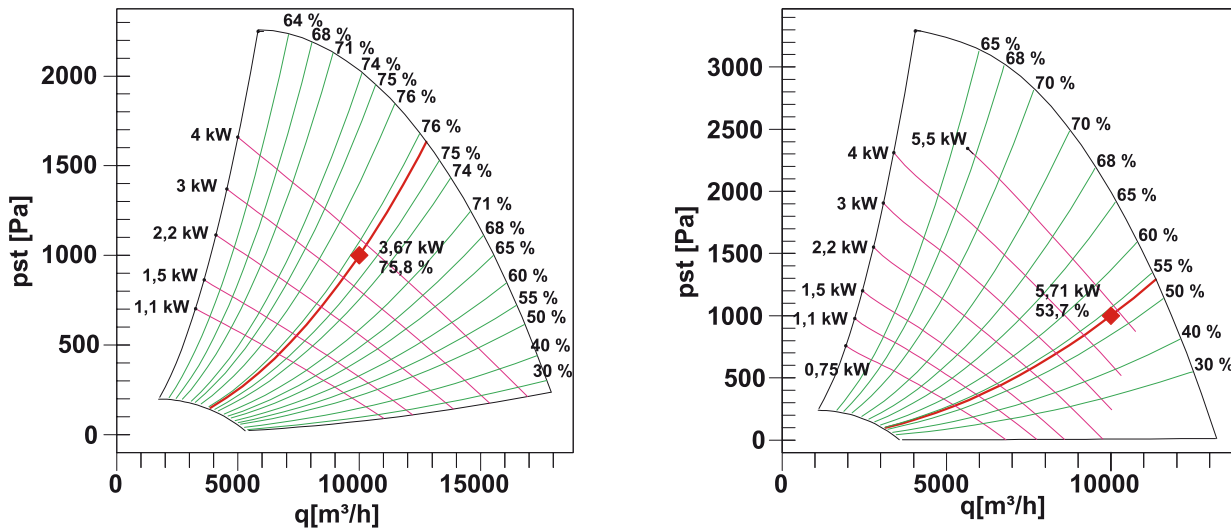

Figure 6. Comparison of two fans of different sizes operating at the same operating point but with different efficiency. The left diagram is nominal size 500 mm and the right one for a fan of nominal size 400 mm.

because it only limits the minimum total fan efficiency at the best efficiency point, which can be in practice far away from the real operating point, where efficiency is considerably lower.

If a contractor installs the fan from the **Figure 6** (right) into a system that operates 4000 hours per year, it will use 22 840 kWh of electricity. The electricity cost per year at a price of 0.10 €/kWh will be 2 284 €. If a contractor would install the more efficient fan (**Figure 6** left) it would use 14 680 kWh of electricity at a cost of 1 460 € per year. A specification of the more efficient fan would save the building owner or tenant 816 € per year or 12 240 € in 15 years. It is evident, that the installation of a ca. 500 € cheaper fan will cause considerably higher electricity use and costs to the owner or tenant.

In order to prevent such situation from occurring in practice, an engineer should always specify at least the following data; airflow, external pressure, total fan efficiency, grid power, air temperature rise. Besides that, voltage and type of motor should also be specified in order to eliminate the problem of compatibility between the fan and the electric network.

Control strategies

Control allows a fan to adapt airflow and/or pressure to the needs of a system. If we consider that the suggested SFP for new building is 2.0 kW/(m³/s) or 2.0 W/(l/s), for every litre of air per second that is moved around without purpose, 2 W of energy is wasted just for the transport its transport. The energy wasting can be several times higher if heating and cooling of the air are also considered.

Traditionally fans were usually not equipped with any of the control strategies and run at constant speed. Some belt driven fans have relied on gear mechanisms to change the fan speed and thus control air flow in steps. Other control types included pressure dampers, vane angle and bypass to control volume flow in the system. However, these systems are not energy efficient because the fan speed is not reduced.

According to the fan affinity laws, fan power is proportional to the third power of the ratio of fan speed:

$$P_{r2} = P_{r1} \times (n_2 / n_1)^3 \quad \text{(Equation 1)}$$

where P_r is the mechanical input to the impeller and n is the fan rotational speed. That means, if fan rotation speed is reduced by 10%, the fan power will reduce 27%. The most efficient way to reduce fan energy use in variable flow is to reduce fan rotation speed, which can be most efficiently achieved with frequency controlled electric motors.

The biggest advantage of using speed-controlled fans is when they are used in variable air volume flow systems (VAV). Fan power can be considerably reduced in the part-load range if air volume flow is reduced:

$$P_{input} = \frac{P_{tot} \cdot \dot{V}}{\eta_{tot}} \quad \text{(Equation 2)}$$

where P_{input} is electrical power absorbed by the motor from the grid (W), P_{tot} is total pressure across fan (Pa), \dot{V} is air volume flow (m³/s) and η_{tot} is total fan efficiency (%).

The relation in **Equation 2** between fan input power and air volume flow is linear if total pressure and efficiency are constant. In practice, total fan efficiency and pressure vary if volume flow is changing. For a fixed system, it may be said that the system resistance (equal to the pressure required to pass a given volume of air through the system) will vary as the square of the volume flow rate, i.e. $p_f \propto q_v^2$. Therefore, to double the airflow, a pressure four times greater is required from the fan. This is only true for a static system and constant air density. If the resistance of the system can be altered, e.g. by closure of a damper, then the above laws do not apply and the relation between pressure and flow is much more complicated. The efficiency in **Equation 2** is also reduced by decreasing airflow due to the part-load losses in electric motor and variable speed drive (**Figure 7**). The decrease in efficiency is greater in the case of AC motor controlled by a VFD because they have lower part load efficiencies than EC motors. This Figure also suggests that fan should not be sized with a reserve on air volume flow side. In contrast to reserve on the pressure side, reducing volume flow does considerably affect efficiency of a fan.

All new fans are suggested to be speed controlled by using EC motors, which have integrated VFD, or AC motors with an external VFD. On the first sight it may seem that a VFD in addition to an AC motor is useless or even unfavourable due to its losses in constant air volume flow systems (CAV). However, pressure conditions vary in every ventilation system which is equipped with filters, because filter pressure drop changes through time as filters get soiled. Buildings are rarely static systems. There may be significant alterations in the function or capacity of ventilation systems, which often require reset of fan operation point. Another advantage of variable frequency drives is that they allow for small pressure reserve on the fan size during the design phase. If pressure reserve is used when selecting single speed fan but the resistance of a real system is lower, a fan will operate at a higher flow rate and thus waste energy. If a variable EC motor or VFD is used in such situation, it will allow for changes of the fan speed and thus pressure of fan – air volume flow can easily be adapted to the designed air flow and energy waste is avoided. An example in **Figure 8** shows that the efficiency does not decrease dramatically when the static pressure of an EC fan is decreased (in case when a fan was selected with some pressure reserve).

Conclusion

Fans are one of the major electricity users in HVAC systems. In order to achieve good efficiency of fans once they are installed, it is not enough just to select best products on the market, but also to change design and

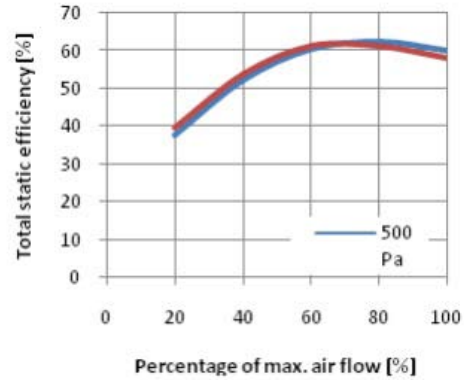

Figure 7. Total static fan efficiency of a backward curved EC fan without casing (100% = 10 000 m³/h). By reducing the airflow, efficiency first increases because the 100% operating point was selected on the right side of the best efficiency point. (Calculated with Ziehl-Abbeg fan selector)

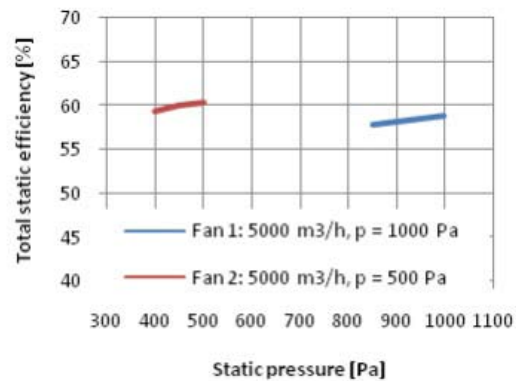

Figure 8. Total static efficiency decrease of the same fan as on the left chart due to the lower operational static pressure (Calculated with Ziehl-Abbeg fan selector).

and selection procedure to fit such technology. With increased number of variable air volume systems entering the market, old principles of design that are embeded in minds of engineers have to be changed and alligned with the development of technology.

References

EC (2011). Commission Regulation (EU) No 327/2011 of 30 March 2011 implementing Directive 2009/125/EC of the European Parliament and of the Council with regard to Ecodesign requirements for fans driven by motors with an electric input power between 125 W and 500 kW. Retrieved from <http://eur-lex.europa.eu/LexUriServ/LexUriServ.do?uri=OJ:L:2011:090:0008:0021:EN:PDF>

EN 13779:2007. Ventilation for non-residential buildings - performance requirements for ventilation and room-conditioning systems. European Committee for Standardization (CEN), 2007. **3E**

Your Comfort, our Passion



Alfa Laval has a passion for comfort. You will find our products and solutions in heating, cooling and tap-water systems in homes and buildings worldwide. They provide a level of comfort that truly enhances the quality of life.

When it comes to conserving the world's resources, we are equally passionate. This is clearly reflected in our energy saving solutions and our focus on making renewable energy sources key elements of our Comfort and HVAC offerings.

Alfa Laval – a partner with passion



www.alfalaval.com/hvac

Ventilation and Energy – maybe not that irreconcilable



Vitor M. S. Leal

Department of Mechanical Engineering
Faculty of Engineering of the University of Porto
vleal@fe.up.pt



Hugo R. R. Santos

Department of Mechanical Engineering
Faculty of Engineering of the University of Porto
hrsantos@fe.up.pt

Air change is one of the four natural components of the thermal balance of buildings, along with transmission through the envelope, internal gains and solar gains. These can be, and in most E.U. buildings in fact are, complemented by the artificial components of mechanical heating and/or cooling. However, the amount of heating and/or cooling that each room requires to be kept at a comfortable temperature depends on the results of the four natural components. This interaction will be here analyzed specifically in what regards the relation between air change and energy conservation, traditionally thought to be two conflicting interests.

The main mode of air change of rooms is Ventilation. It can occur naturally or be mechanically driven, but in either case it has the primary goal of removing “polluted” air from indoors and replace it with clean(er) outdoor air. The air flow of ventilation that is needed for each room is usually determined, directly or indirectly, by indoor air quality requirements. It does however have an important impact on the energy balance of buildings. This impact can, in some moments of the year, be favorable the energy economy. E.g., increasing the air flow in mid-season or summer in cold or mild climates can contribute to decrease the energy demand for cooling (night cooling and free-cooling). However it is clear that for most buildings and European climates the effect of air change that dominates is the increase of the energy demand for heating.

In fact, the notion that ventilation has a negative impact on the objectives of energy conservation has long

set foot on the policy-making fields. It is a matter of historical record that there was sometimes a trend for ventilation rates to decrease when the price of oil had increased. Not even the progresses of the latest years, when new technologies such as mechanical ventilation with heat recovery or demand-control ventilation, have appeared, or been perfected, or become affordable, have removed this perception. And, in fact, it should not be taken for granted without a thorough analysis that they do fully solve the problem in every climatic context. For instance, mechanical ventilation with heat recovery or free-cooling saves thermal energy but requires additional electricity to drive the fans, therefore producing a trade-off that must be analyzed in the diversity of contexts before general conclusions are drawn.

An opportunity for such a thorough analysis considering the wide diversity of climates, building types, building characteristics and ventilation systems was recently

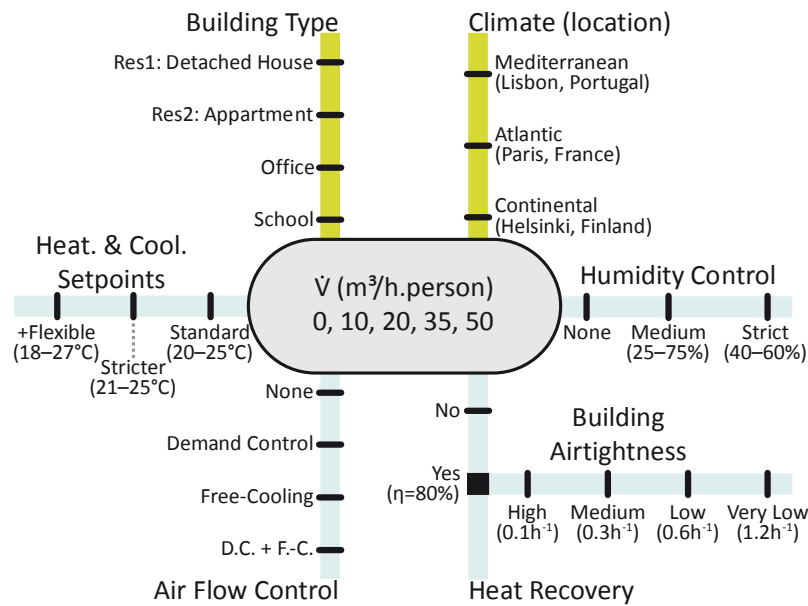

Figure 1. Schematic view of variables addressed in the study.

created in the frame of the Healthvent project (www.healthvent.eu). This project has the quite ambitious goal of developing a rationale to identify the recommendable ventilation practices for the most important building types (or room types) from a purely health-based criteria. Energy does not play there an important decision role, but it is intended that the impact of the health-based recommendations – yet to be finalized – be assessed in several dimensions, including impact on energy demand and GHG emissions.

The framework created for this analysis of the energy impact of ventilation rates is represented in **Figure 1**. It tries to capture the diversity of climates, building types, building characteristics and ventilation systems existing in Europe. A main decision was that the “impact of ventilation rates” would be assessed through the slope of the graphical representation of the results of the calculated energy demand versus the ventilation rate, thus resulting in the units of [(kWh/m².a)/(m³/h.person)]. This impact was assessed at two levels: first at the level of thermal energy needs for heating and cooling, and second in terms of overall energy for heating, cooling and moving the air. The results later confirmed that this relation is nearly linear in almost every case analyzed, thus validating the approach. In order to find the slope, each case-study was run at five different ventilation rates, ranging from 0 to 50 m³/h.person.

Besides the ventilation rate, the other variables identified as being of problem-shaping nature were the building type (four considered: a detached dwelling, an apartment, an office and a school), the climate (three considered: Lisbon, Paris and Helsinki), the heating and cooling set points (standard 20–25°C, stricter 21–25°C or flexible 18–27°C), the type of air flow control (no control/constant ventilation, demand control, free-cooling, combined demand control and free-cooling), humidity control (none, medium allowing a band between 25% and 75% RH, and strict imposing a band between 40% and 60%) and the existence of heat recovery. This latter requires balanced or nearly balanced ventilation to operate at maximum efficiency, and therefore prompts the issue of the airtightness of the building envelope (the cases of 0.1, 0.3, 0.6 or 1.2 ach⁻¹ on average were considered).

The variables were organized and discretized according to **Figure 1**. For each building and climate a base-case combination of the characteristics was defined. The characteristics of building envelope and operation were adapted to each climate, according to information supplied by local experts, and are summarized in **Table 1**.

A sensitivity analysis was performed to one variable at a time, starting from the base-case. In the end, an “advanced system” combining advanced features in each of

the variables was also considered. This “advanced system” is characterized by a very airtight envelope, high efficiency heat recovery, demand control and free-cooling. **Table 2** shows the characteristics of the base-case for each building and climate, as well as the characteristics of the advanced system considered.

The results were first assessed in needs of thermal energy for heating and cooling. This assessment was performed through dynamic simulation with the software ESP-r. **Figure 2** shows these results for the detached dwelling for the base-case and for the advanced system in each

of the three reference climates considered. The results show very clearly that the slope of the variation “thermal energy vs. air flow” becomes much lower with an advanced system than with the base-case/current practice systems in most building-climate combinations. In many cases with the advanced system this slope even becomes nearly zero, revealing an almost negligible influence of the minimum ventilation air flow rate in the thermal energy demand.

In order to integrate into the analysis the energy needed to drive the fans, as well as to consider the fact that

Table 1. Main characteristics of the four building models analyzed.

		Dwelling	Apartment	Office	School	
Useful Area (m ²)		150	72	298	464	
Regular Occupants		4	3	32	136 children + 10 adults	
Designed Occupation		8	6	35	152	
Vent. hours/day & days/week (without demand. control)		24/7	24/7	13/5	11/5	
Typical Infiltration Rate (ach ⁻¹)		Lisbon	0.6	0.6	0.6	
		Paris	0.3	0.3	0.3	
		Helsinki	0.1	0.1	0.1	
U-Values [W/(m ² ·°C)]	Exterior Wall	Lisbon	0.46	0.57	0.57	
		Paris	0.16	0.16	0.16	
		Helsinki	0.16	0.16	0.16	
	Interior Wall 1	Lisbon	1.77	1.7	0.9	
		Paris	0.25	0.27	0.43	
		Helsinki	1.77	1.4	0.26	
	Interior Wall 2	Lisbon	0.47	1.2	n.a.	
		Paris	0.17	0.43		
		Helsinki	0.18	0.45		
	Floor Slab	Lisbon	1.72	1.77	1.2	
		Paris	0.37	0.39	0.39	
		Helsinki	1.72	1.77	1.2	
	Roof Slab	Lisbon	0.41	n.a.	n.a.	0.4
		Paris	0.29			0.1
		Helsinki	0.09			0.09
	Ground Slab	Lisbon	0.67	n.a.	n.a.	0.67
		Paris	0.22			0.19
		Helsinki	0.17			0.16
	Windows	Lisbon	2.7	2.7	2.7	2.7
		Paris	1.5	1.5	1.5	1.5
		Helsinki	1.0	1.0	1.0	1.0

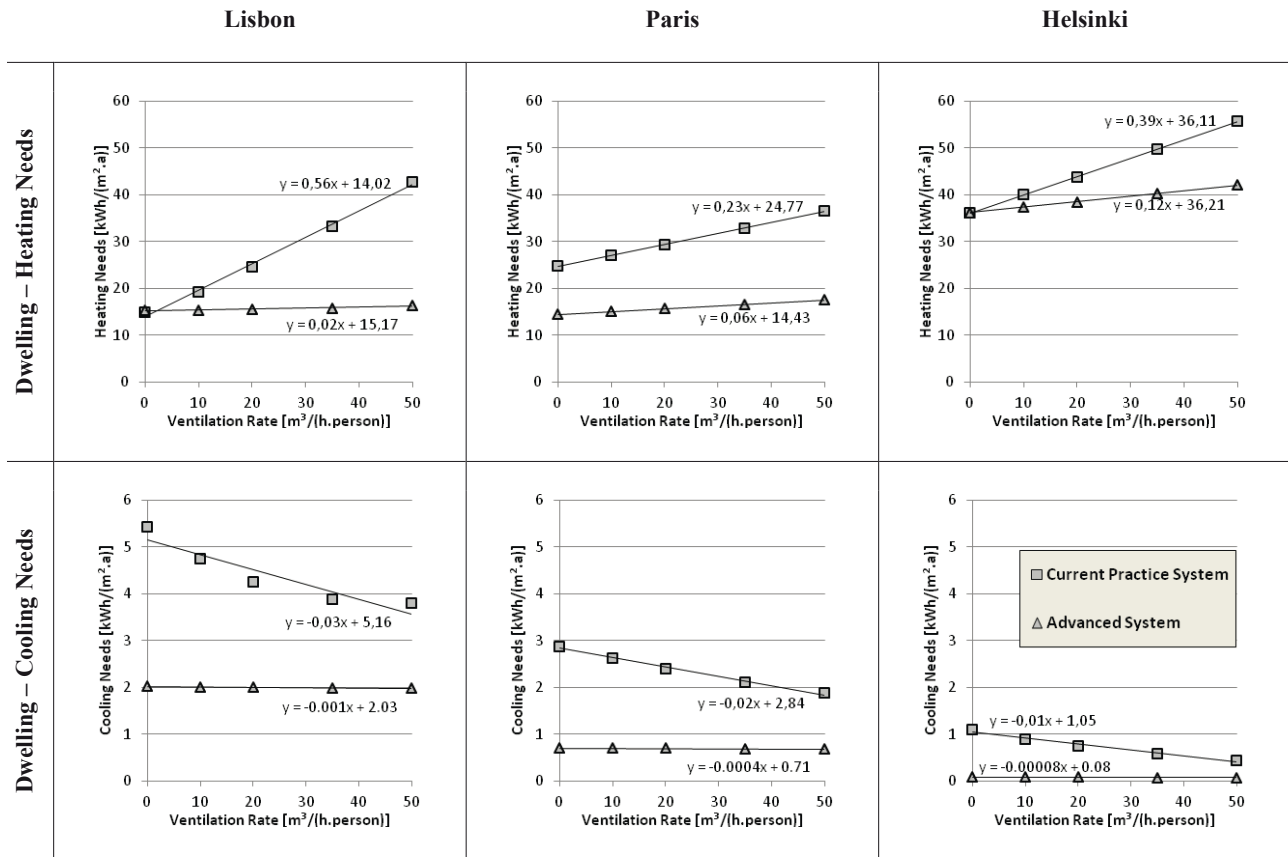

Figure 2. Heating and cooling needs versus ventilation rate with typical and advanced systems in the dwelling model and in three locations.

Table 2. Characteristics of the current practice system and of the advanced systems considered.

	Dwelling		Apartment		Office		School	
	Curr. pract.	Adv. sys.	Curr. pract.	Adv. sys.	Curr. pract.	Adv. sys.	Curr. pract.	Adv. sys.
Lisbon								
Av. Infiltration Rate (ach ⁻¹)	0 *	0.1	0 *	0.1	0.6	0.1	0.6	0.1
Ventilation Control	None	DCFC	None	DCFC	None	DCFC	None	DCFC
Heat Recovery	No	Yes	No	Yes	Yes	Yes	Yes	Yes
Paris								
Av. Infiltration Rate (ach ⁻¹)	0.3	0.1	0.3	0.1	0.3	0.1	0.3	0.1
Ventilation Control	None	DCFC	None	DCFC	None	DCFC	None	DCFC
Heat Recovery	Yes	Yes	Yes	Yes	Yes	Yes	Yes	Yes
Helsinki								
Av. Infiltration Rate (ach ⁻¹)	0.1	0.1	0.1	0.1	0.1	0.1	0.1	0.1
Ventilation Control	None	DCFC	None	DCFC	None	DCFC	None	DCFC
Heat Recovery	Yes	Yes	Yes	Yes	Yes	Yes	Yes	Yes

* the building is considered to be over-pressured, hence eliminating infiltrations.

DCFC: Demand-control and free-cooling.

► heating and cooling are usually provided with different efficiencies, an analysis was also made in terms of delivered energy. For this purpose the reference conversion scheme considered that heating is provided by a heat pump-base system (either air or ground-source), that cooling is provided by a refrigerating machine and that in the cases of mechanical ventilation air is moved through a duct and fan system with an average specific fan power. It must however be stressed that the adoption of this reference system was made only for convenience for integrating the several components of the HVAC energy demand into a single indicator – it therefore does not necessarily represent a recommendation in itself.

Figure 3 shows the impact of changing the air flow rate by $10 \text{ m}^3/(\text{h}.\text{person})$ in the total electricity consumption for heating, cooling and moving the air, with the current practice system and with the advanced system. As had happened for the thermal energy alone, the results show that the impacts of the variations are much smaller with the advanced system than with the current practice system. In the case of the advanced systems, the impact of changing the ventilation rate by $10 \text{ m}^3/(\text{h}.\text{person})$ is never more than $2 \text{ kWh}/(\text{m}^2.\text{year})$ in delivered energy.

Figure 4 expresses the previous results in the form of percent change implied by a hypothetical increase of the ventilation rates from $20 \text{ m}^3/(\text{h}.\text{person})$ with a current practice system to $30 \text{ m}^3/(\text{h}.\text{person})$ with an advanced system. It shows that, in all but two cases, should there be a need to increase ventilation rates – something that is far from being established but which is not the topic of discussion here – the energy impact of this measure could be effectively mitigated by adopting more advanced ventilation systems and airtight envelopes.

While these results confirm that the impact of increasing or decreasing ventilation rates in a “per person” base can be effectively mitigated, at least two other important

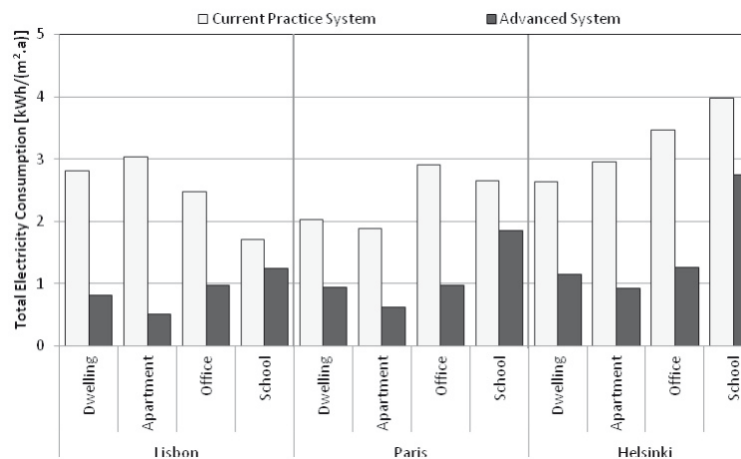

Figure 3. Impact upon total HVAC-related delivered energy of changing ventilation by $10 \text{ m}^3/(\text{h}.\text{person})$, in a scenario with a current practice system and in a scenario with an advanced system, for different locations and case-study buildings.

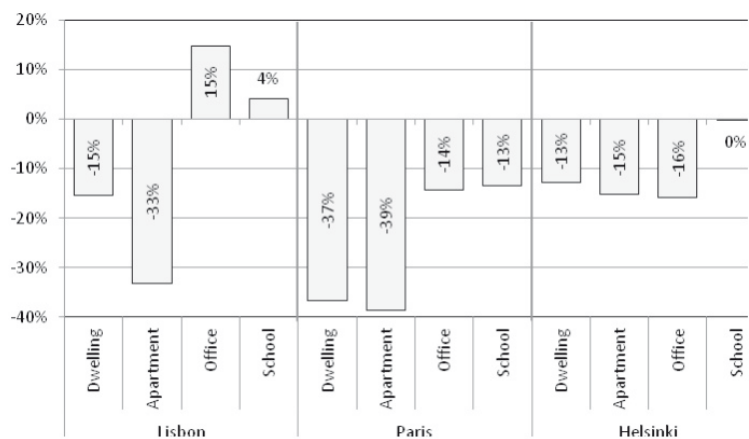

Figure 4. Percent change in HVAC-related delivered energy demand if hypothetically but simultaneously increasing the ventilation rate from $20 \text{ m}^3/(\text{h}.\text{person})$ and adopting advanced ventilation systems with airtight building envelopes, heat recovery, demand control and free-cooling.

questions arise that require further study. One is the issue of the cost-effectiveness of adopting advanced systems “everywhere” in Europe. The other, not less important, is whether very airtight buildings are compatible with the local culture of many European regions, where the building is often perceived, at least for a significant part of the year, more as an extension from the outdoor environment than as a shelter from it. **3E**

light+building

The world's leading trade fair
for Architecture and Technology

Frankfurt am Main, 15 – 20. 4. 2012

Top themes:

Digitalisation of light and buildings.
Buildings as power stations.

- > Lighting
- > Electrical engineering
- > Home and building automation
- > Software for the construction industry

www.light-building.com



messe frankfurt

Performance Certification of Refrigerated Display Cabinets (RDC)

The European Union is currently implementing some directives on equipment intended for use in residential, service and commercial buildings. The text concerning the performance characteristics of refrigerated display cabinets according to ISO standard ISO 23953:2005, which will impose minimum efficiencies, is now being completed. To better differentiate the products, Eurovent Certification has defined energy categories based on factory audits and independent laboratory testing, and in order to ensure a realistic sizing of facilities, some coefficients for use in stores.



Sandrine Marinhas
Eurovent Certification Company (ECC)
53 rue de Turbigo – 75003 Paris
s.marinhas@eurovent-certification.com

Nomenclature

BOM	bill of material - list of components	DEC	direct electrical energy consumption, kWh/day
Eff	efficiency, kWh/day/m ²	TDA	total display area, m ²
EEl	energy efficiency index	TEC	total electrical consumption, kWh/day
REC	refrigeration electrical energy consumption (of the condensation unit), kWh/day		

Introduction

The EU heading for the 20-20-20

In December 2008, the European Union (EU) adopted an extensive set of measures intended to reduce overall energy consumption in Europe and to guarantee the EU a safe and sufficient energy supply. The aim is to achieve a 20% reduction in Europe's greenhouse gas emissions by 2020, in comparison with 1990 levels, while increasing the use of renewable energy sources by 20%.

From a practical standpoint, several actors are involved in the process of drafting and applying the texts. In the European Commission, the commissioners, appointed for five-year terms and grouped into General Directorates (DG), propose legislative texts and oversee their correct application within the EU. These proposals are based on studies performed by consultants mandated by the European Commission, who describe the market and target the best lines of improvement. The ministers of the Member States then meet to debate legislative texts

that they will adopt jointly with the Parliament (whose members, called Members of the European Parliament, are directly elected by the citizens every five years).

Reducing the energy consumption of supermarkets ...

Generally, when equipment is bought, prescribers' demands, apart from size constraints, aesthetic considerations and other budgetary criteria (sometimes predominant), increasingly tend towards energy criteria, particularly because of the incentives implemented by the Member States. For a display cabinet we will therefore consider, in the first place, the capacity of the unit used to maintain products (symbolized by M-packages simulating the products) within a given temperature range, called "temperature category". We will then examine its energy performance data: the cooling capacity, evaporation temperature, the power consumption of the cabinet and its energy efficiency.

... by means of a simplified reading of the equipment efficiency

Further on in this article, we will show the complexity of the products that interest us to demonstrate that a simplified display is necessary for the specifiers. By going beyond the simple prohibition of equipment that does not ensure a minimum efficiency, the introduction of a scale of energy efficiency classes subtly encourages buyers to invest in more economical equipment. We can, in addition, guarantee the levels announced when equipment is tested in independent laboratories, and the components of the tested cabinets can be checked against production in the factory thanks to manufacturing site audits. Finally, the implementation of common coefficients for the transposition of performance data in the laboratory to performance in the store is a step forward

towards a quicker assessment of the electrical power consumption of a facility equipped with cabinets.

Physical description of the equipment

The different categories of refrigerated display cabinets

There is a variety of refrigerated display cabinets. The first distinction consists of determining whether they house

their own condensing units or are elements of a centralised system. In this document we will focus mainly on the latter type. We will now define a breakdown into five categories according to the cross-section of the cabinet (**Figure 1**).

The standard regarding display cabinets includes a coding system consisting of three letters and a number. An 'I' or an 'R' will be used for cabinets housing their

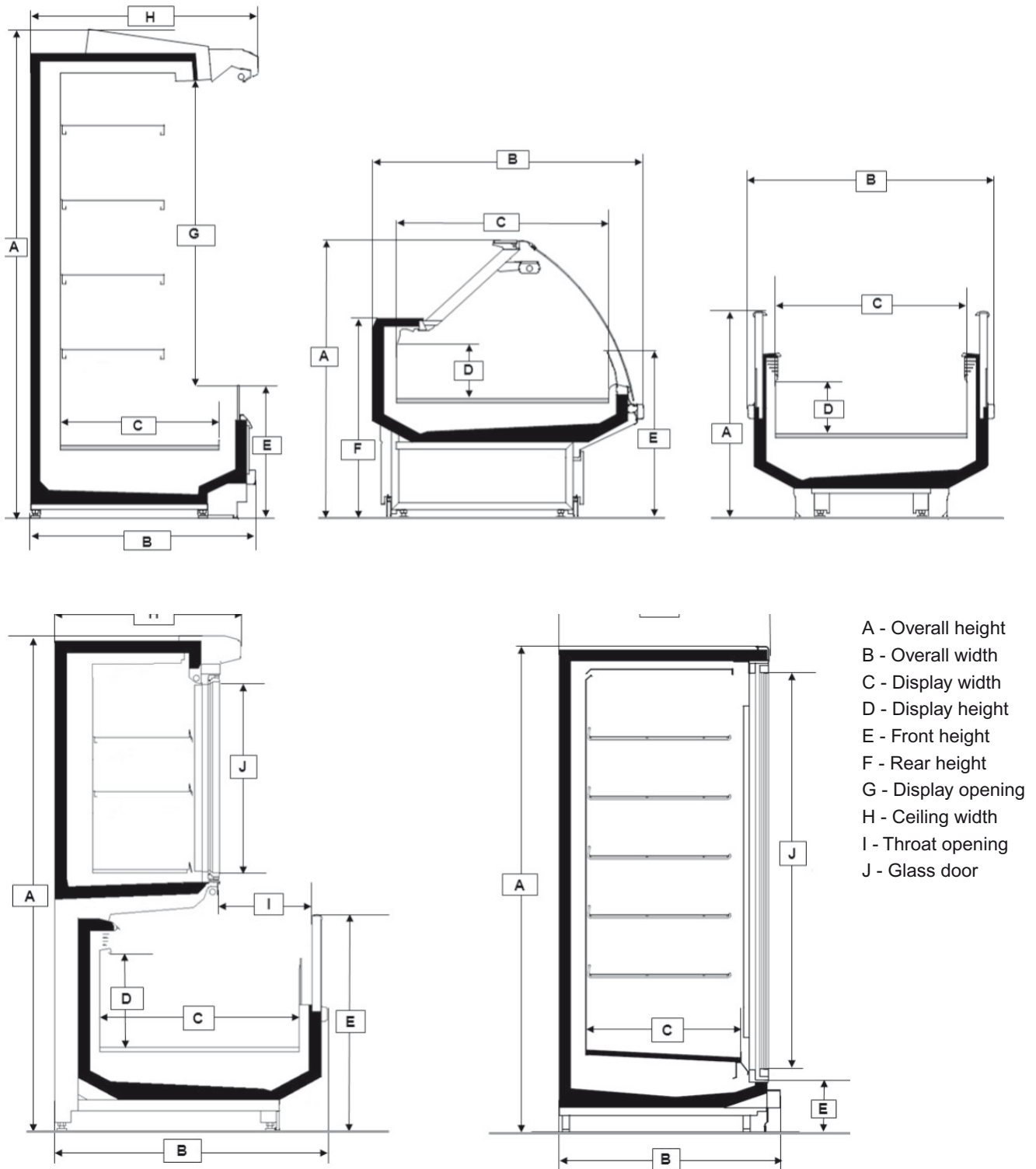

Figure 1. Kinds of cabinets and dimensions certified for (a) verticals and semi-verticals open, (b) service counters, (c) islands (d) combi-freezers and (e) verticals and semi-verticals with doors.

Table 1. The 100 Pre-defined categories and Basic Model Groups of Remote RDCs.

Category 1: Vertical or semi-vertical cabinets with doors (RVC4, RVF4)						
Height [mm]	Depth [mm]	Chilled or Frozen	Loading	Number of shelves	Lighted shelves	
≤1800	≤900	Chilled	any	any	N(o)	
1800–2150	900–1000	Frozen				
>2150	>1000					TOTAL 18
Category 2: Vertical and semi-vertical open (RVC1, RVC2, RVC3)						
Height [mm]	Depth [mm]	Frontal height [mm]	High depth	Loading	Night cover	Lighted shelves
≤1800	≤900	≤250	>700	any	Y if available	N
1800–2150	900–1000	250–440	≤700			
>2150	>1000	>440				TOTAL 54
Category 3: Islands (RHF3, RHF4, RHF5, RHF6, RHC3, RHC4, RHC5, RHC6)						
Outside depth [mm]	Glass front	Sliding panels	Loading depth	Temperature range	Lighted shelves	Night cover
≤1400	Y (Yes)	Y	any	any	N	Y if available
1400–1700	N	N				
>1700						TOTAL 12
Category 4: Counters (RHC1, RHC2, RHC3, RHF1)						
Presentation length [mm]	Chilled or frozen	Superstructure				
	Chilled	Traditional open				
≤930	Frozen	Traditional closed				
>930		Self-service				TOTAL 12
Category 5: Combined (YF1, YF2, YF3, YF4)						
Height [mm]	Glass front height	Sliding panels	Light: N at back	Chilled or Frozen		
≤2150	any	Y	N	Chilled		
>2150		N				TOTAL 4

condensing units ('I' for Integral) or remote condensing ('R': Remote). An 'H' or a 'V' will indicate whether the cabinets are horizontal (H) or vertical (V), followed by a 'C' or an 'F' to identify cabinets intended for refrigerated products (Chilled: C) or frozen goods (Frozen: F). Finally, a number completes the description by giving even more information on the structure.

By defining groups by sizes and common characteristics, we arrive at 100 preconfigured definitions, called basic model groups (BMG) (Table 1 [1]). When manufacturers declare two representative cabinets per basic model group, it is considered that this corresponds to 80% of the market.

The characteristics that influence energy performance

At this point we should identify, for each configuration, the characteristics of the representative cabinet component by component. Indeed, the interior fittings and accessories have a by no means negligible influence on the refrigerating behaviour of the cabinet and, consequently, on its energy efficiency. This nomenclature (called Bill

of Material or BOM) will be made possible by the precise description of the elements listed below:

- the cross-section of the cabinet, the configuration of shelves – if any, thus defining the useful display area (in other words, the container)
- the air flow configuration
- the lighting
- the night cover, if included
- the doors or sliding doors, in the case of closed cabinets
- the evaporator(s) and the associated fan(s)
- the defrost system

In the case of cabinets that house their condensing units, a compressor, a condenser with fan(s) and a condensation water discharge system would also be added.

Energy performance of the display cabinets under test conditions

The test conditions

Eight sets of test conditions are defined at the international level in ISO standard 23953:2005 for the determination

Table 2. “Climate 3” test conditions according to ISO standard 23953:2005.

Test chamber climate	Dry bulb Temperature (°C)	Relative humidity	Dew point [°C]	Absolute humidity $lg_{water/kg_{dry\ air}}$
Climate 3	25	60	16.7	12

Table 3. The temperature categories according to ISO standard 23953:2005.

		3L1	3L2	3L3	3M0	3M1	3M2	3H2
θ_b – the lowest temperature of the coldest package must be higher than or equal to	[°C]	-	-	-	-1	-1	-1	-1
θ_h – the highest temperature of the warmest package must be lower than or equal to	[°C]	-15	-12	-12	4	5	7	10
θ_b – the lowest temperature of the warmest package must be lower than or equal to	[°C]	-18	-18	-15	-	-	-	-

of the performance characteristics of a display cabinet. The set that most closely resembles the conditions of a store in Europe is number 3, whose data are defined in **Table 2**.

Temperature classes

In order to be able to certify a given temperature category, the equipment is tested according to the methods described by ISO standard 23953:2005 under the aforementioned conditions. The products are simulated by using packages called M-Packages, and the testing personnel make sure that their temperature stays within the ranges given in **Table 3**.

The performance characteristics

When the cabinets with remote condensing units are tested, the refrigeration electrical energy consumption *REC* (of the condensing set) is determined as well as the direct electrical energy consumption *DEC* from which the total electrical consumption *TEC* is deduced, with (it should be noted that for self-contained condensing cabinets the equation is $REC = 0$ and $TEC = DEC$ which includes the compressor energy):

$$TEC = REC + DEC \tag{1}$$





The next step is to determine the efficiency of the equipment under laboratory conditions; the efficiency corresponds to the consumption divided by the display area (Total Display Area) TDA:

$$Eff = TEC / TDA \tag{2}$$

It will be noted that the lower the Eff value, the more efficient the cabinet. It will thus be considered more as a standardised consumption than as an efficiency rating as such. In order to classify the cabinets among themselves, the following Energy Efficiency Index (EEI) has been defined:

$$EEI = \frac{\left(\frac{TEC}{TDA}\right)_{measured}}{\left(\frac{TEC}{TDA}\right)_{reference}} \times 100 \tag{3}$$

Table 4. The reference values for energy efficiency by cabinet type.

Type of cabinet	Temperature category	TEC/TDA reference value		
	RHC1	3H	6.2	
		3M2	6.7	
		3M1	7.2	
	RHF1	3L3	21.0	
		RHC3,	3H	5.5
			3M2	5.8
	RHC4	3M1	6.2	
	RHF3,	3L1	15.0	
		3L2	14.0	
	RHF4	3L3	13.0	
	RHC5,	3H	4.3	
		3M2	4.7	
	RHC6	3M1	5.0	
	RHF5,	3L1	12.0	
		3L2	11.2	
	RHF6	3L3	10.4	
	RVC1,	3H	10.1	
		3M2	12.3	
	RVC2	3M1	13.4	
		3M0	14.5	
	RVC3	3H	13.8	
		3M2	16.0	
RVF1	3L3	29.0		
	RVC4	3L1	28.5	
		3H	6.1	
		3M2	7.4	
		3M1	8.0	
	3M0	8.7		
	RYF3	3L2	30.0	
		3L3	29.0	
	RYF4	3L2	28.5	
		3L3	27.6	

The reference data correspond to arbitrary values determined statistically after gathering sales data from major manufacturers on the European market. These data allow the establishing of an energy label, as shown in **tables 4 & 5**, using the classic lettering already used by the well known labels for electrical appliances such as washing machines or refrigerators.

Table 5. The energy efficiency categories based on EEI.

Energy efficiency index EEI	Energy efficiency category	Energy efficiency index EEI	Energy efficiency category
$EEI < 55$	A	$100 \leq EEI < 110$	E
$55 \leq EEI < 75$	B	$110 \leq EEI < 125$	F
$75 \leq EEI < 90$	C	$125 \leq EEI$	G
$90 \leq EEI < 100$	D		

Mastered processes, well-sized supermarkets, minimum efficiency, efficient label

To provide customers with a guarantee of the best efficiency levels and, more generally, to increase the transparency of the data on the European market, Eurovent Certification (ECC) independently certifies more than 50 000 references for 20 kinds of products in the ventilation, air conditioning and refrigeration fields [2]. The certification of refrigerated cabinets covers several international brands, some of which have been certified for ten years now. The principle underlying this certification is the annual inspection (audit) of production facilities as well as testing in independent laboratories every six months. The purpose of the audit is to ensure that the products turned out by the factories perfectly match the declared characteristics of the models. During the visit, the auditor checks the production line and reviews recent orders to verify their compliance. By regularly testing the finished units according to the terms of ISO standard 23953:2005 and its amendments, the auditors ensure that the efficiency levels are in phase with those indicated in the catalogues. The entire process is an active and efficient means of ensuring that a B-labelled cabinet will not turn in performance data equivalent to those of a D.

Since May 2010, the performance data have been published in a new format in which they are uniformly transposed to represent the conditions in a store. Indeed, in the supermarkets the refrigerated cabinets are placed together in such a way that the ambient conditions are less homogeneous but milder than those stipulated in the standard, as shown schematically in **Figure 2**. The efficiency shown is thus closer to actual conditions and the facilities are thus better sized, reducing the overall energy bill.

With the goal of reducing energy consumption in the EU, the European Commission relies on directives

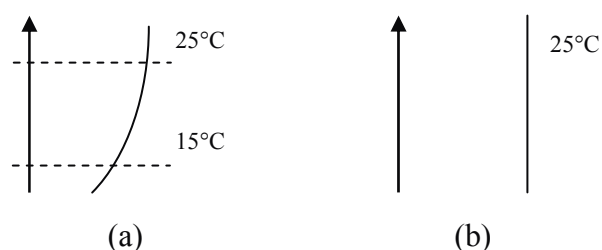



Figure 2. Simplified depiction of the ambient temperature conditions in a store (a) compared to temperature conditions in a laboratory.

which must subsequently be transposed or directly applied by all of the Member States. Among its tools, the “ErP” directive (Eco-design for Energy related Products) 2009/125/EC defines the minimum energy efficiencies, or Labelling, for energy labelling [3]. Each product family (for example: televisions, light bulbs, etc.) is covered by a “Lot” [4]: refrigerated display cabinets have been studied in the framework of “Lot 12”. The implementing measures are still being drafted, after several delays, but the efficiency thresholds can be foreseen. According to these thresholds, the G-class cabinets might be prohibited on the European market. Moreover, the implementation of an energy label will give rise, among the manufacturers, to better efficiency. Thus, the prescribers will select more efficient units.

References

- [1] S. Marinhas, Operational Manual and Rating Standard for the Certification of Remote Refrigerated Display Cabinets, Eurovent Certification (2010).
- [2] <http://www.eurovent-certification.com>
- [3] S. Marinhas et al., Air-conditioning, air handling and refrigeration equipment: European-wide certification, standards and European directives on energy efficiency, *Rehva Journal*, vol. 18 (2010), 31-34.
- [4] http://ec.europa.eu/enterprise/policies/sustainable-business/ecodesign/index_en.htm 



Now we can do anything. Almost.

You know of course, that Swegon is one of the leading suppliers of air handling units, water- and airborne climate systems, flow control, acoustics and residential ventilation products. But we can do more than that. Now we can do cooling. Our new range of Blue Box chillers and heat pumps truly turns us into a unique supplier of comprehensive solutions and systems in the ventilation and air conditioning sector. Our highly innovative Blue Box range comprises hydronic, close control, roof-top and direct expansion units. And – as all the other Swegon products and systems – the new Blue Box chillers and heat pumps come along with Swegon's outstanding competence and personal service. Let us show you what we can do for your project and which advantages you get by choosing a holistic supplier who can do anything. Ok, almost anything.

Now that we can do (almost) anything, what can we do for you?



Building Integrated System Design for Sustainable Heating and Cooling



WaterTraditional water based systems operating at optimal temperature levels represent a low tech but easy and accessible potential for energy optimisation and integration of renewable energy in the construction sector.

Good Indoor Environment with Low Energy Use Required

The requirements to modern buildings are numerous. Energy consumption must be minimised and the necessary building services must be provided in the most sustainable way in order to ensure adequate indoor climate and healthy conditions for the users. Improved energy efficiency is among the fastest and most cost efficient ways of lowering energy consumption but is often not offered the same attention as new and more exotic technologies.

Several tendencies indicate that the cooling needs in buildings are increasing due to changed indoor comfort requirements, more extreme weather types and new

building codes with stricter requirements for the tightness of building envelopes. A promising strategy for sustainable cooling is water based solutions utilising large radiant surfaces at relatively high temperatures, coupled with free cooling sources. By using large surfaces, both heating and cooling can be obtained at temperatures close to ambient, which offer optimal operating conditions for integration of renewable energy and free cooling. In buildings where occupancy pattern yields large cooling loads during day time, embedded water based systems can in addition yield substantial peak load reduction and consequent plant size reduction (Thermo active construction/building).

Sustainable Heating and Cooling

The building sector account for approximately 40% of the total energy consumption and the majority of this energy is used to maintain adequate indoor climate

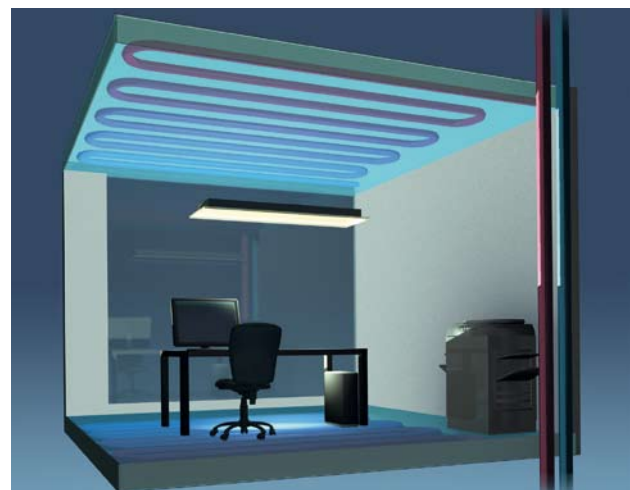

Thermo active constructions works by activating the building's thermal mass with embedded piping. This gives an optimal indoor climate while energy consumption for heating and cooling is minimized. The TAB system is a combined heating and cooling system with pipes embedded in the structural concrete slabs or walls of multi storey buildings, typically applied for buildings where occupancy pattern yields large cooling loads during day time. As the system is often operated asynchronously to the thermal loads of the building, parts of the loads can be shifted from day time to night time, resulting in substantial peak load plant size reduction.

conditions by heating, cooling and ventilation. It is estimated that about a third of this energy consumption can be eliminated by using known technologies with a very short pay back time. There exist thus a big savings potential that can be achieved by an integrated optimisation of the buildings architecture, thermal envelope and the technical HVAC systems.

A sustainable strategy for both heating and cooling is water based solutions utilising large radiant surfaces applying high temperature cooling and low temperature heating. Low energy consumption is this achieved by maintaining a mean operating water temperature (18–28°C) that is close to the ambient temperature. This increases the efficiency of heat sources such as heat pumps and enables the use of renewable energy and sources of free cooling. Radiant systems are embedded in the building's structure, which leaves visually clean surfaces, with no obtrusive and disturbing appliances, and flexible indoor architecture.

Low exergy systems

Both heating and cooling can in principle be obtained at temperature levels that are close to the ambient environment. A low delta T only requires that the heat transmission takes place over relative big surfaces as for example applied in under floor heating systems. The favourable temperature levels make it possible to utilise energy that in principle has a low quality, or more correctly a low exergy content. The exergy concept can be seen as a measure for the quality and availability of a given energy stream. In the recent years a number of international research and demonstration projects have been accomplished focusing on exergy optimisation of energy systems, including the LowEx programme under the international energy agency IEA. The conclusions underline that the future interaction between collective supply systems and the individual building will be a key element for improving the total energy efficiency on district level.

Optimal utilisation of energy sources

Water based systems such as under floor heating and under floor cooling are born as low exergy systems since they facilitate heating and cooling at temperatures close to the ambient environment. Consequently the systems can utilise all sort of energy supply very efficiently, in particular renewable energy sources such as solar, biomass, ground heating and heat pumps. The over all efficiency of most energy sources strongly depends on the supply temperature in the heating system, the lower the supply temperature, the higher the efficiency. This is in particular the case for heat pumps and for condensing boilers (natural gas and biomass). For heat pumps a rule of thumb says that lowering the supply temperature in the heating system by 1°C will yield a reduction of the annual energy consumption by approximately 2%. If the heating system is designed with under floor heating operating at a supply temperature on 30°C instead of radiators with a supply temperature on 50°C this will yield an annual saving

	System 1		System 2		System 3	
	T (°C)	Efficiency	T (°C)	Efficiency	T (°C)	Efficiency
Condensing boiler	80	0.95	80	0.95	80	0.95
Air-cooled chiller	7-12	3.1	7	3.1	7	3.1
Condensing boiler	55	1.0				
Air-cooled chiller	18	3.5				
Heat pump			55	4.05	55	4.05
Reversible heat pump			18	6.50		
Free cooling (ground water)					18	

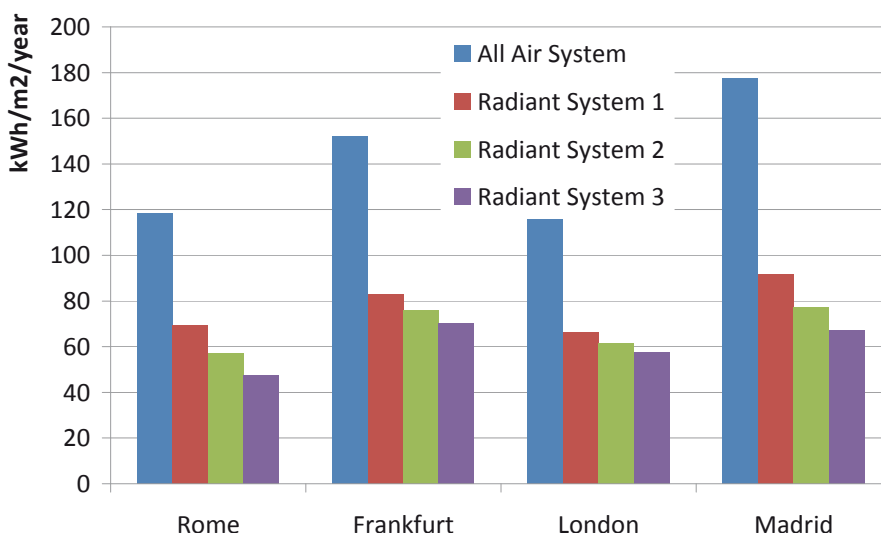

Example of simulated radiant system performance based on a comparison between a system based on a radiant floor and ceiling for heating and cooling and an all air reference system. (Annual primary energy use per square meter of the conditioned area). The simulations are done with EnergyPlus v.3.1.0. and climatic conditions adapted from the IWECC (International Weather for Energy Calculation database of climatic data).

articles

on the energy bill of about 30–40%, dependant of course on the heat pump type and other parameters.

Radiant systems

Heating and cooling systems with water conducted in pipes integrated in the floors, ceilings or walls of a building are named radiant systems, as more than 50% of the energy exchange is by radiation. Typically applied radiant systems for office environments spans from traditional under floor heating and cooling systems over various wall and ceiling integrated systems to thermally active building systems where pipes are embedded into the concrete slabs. Heat output of up to 100 W/m² can typically be achieved with floor and ceiling systems whereas cooling output of typically 60 W/m² is achievable with thermally active building systems and up to 75 W/m² cooling can be achieved with comfort panels for suspended ceilings.

Low temperature heating and high-temperature cooling is the key to energy efficiency in high-performance buildings. With a low-temperature radiant heating system, energy source efficiency will significantly increase in comparison to traditional, high-temperature systems and air heating. This results in reduced primary energy consumption. The feasibility and performance of thermally active building systems has been investigated with results showing energy savings of 25–60 % and thermal comfort yielding a decrease of extended air circulation of 25–75 %.

Integration of renewable energy sources

Using large surfaces as emitters allows heating and cooling at temperatures very close to that of the ambient environment. This means that renewable energy available from the ground, water, sun and air can be integrated and utilised with ease. Ground-source heating can be incorporated into the system via ground heat pumps. Combining a radiant cooling system with a free cooling source can reduce energy consumption by 80–90%, since traditional chillers can be eliminated and only electricity for circulation pumps is needed. Natural-ground water has ideal temperature levels for radiant cooling systems. Alternatively, the systems can be operated with sea-water cooling or solar cooling that uses absorption chillers.

Need for sustainable cooling

Several tendencies indicate that the cooling needs in the entire building mass will increase in the future. This is partly because we experience more extreme weather types with warmer summers and partly because people's requirements for indoor comfort are increasing continuously. New improved building codes with stricter requirements for the tightness of building envelopes also introduces significant cooling demands in summer. This applies in office



BOB (Balanced Office Building), Aachen, Germany. A highly energy efficient office building controlled by advanced building technology. Heating cooling is provided by a TAB system fed by borehole heat exchangers in combination with a heat pump.



BO CAFOD Headquarters, London, England. Occupying a difficult triangular site, the building is an exemplar of sustainable workplace design with cooling provided by a Thermally Active Building System in the exposed thermal mass in situ concrete structure.

and industrial buildings, where cooling is already widely used, but also increasingly in private housing.

Using a combined under floor heating and cooling system, the cooling need can be met by using floor cool-

ing with a flow temperature relatively close to room temperature, typically at 15–17°C. With this favourable temperature level the cooling needs can be covered with minimal energy consumption, for example via free cooling with a ground-coupled heat pump.

Energy efficient cooling is also required for office and industrial buildings. In these building types it is in similar way favourable to utilise high temperature cooling solutions that can exploit free cooling sources and thus reduce energy consumption to an absolute minimum. Water-based cooling solutions in the form of chilled beams and cooling panels are well known in most European markets. Thermo-active constructions, primarily known from Central Europe, are gradually increasing their market share due to their favourable comfort characteristics and energy performance. The principle of a thermo active construction is that pipes integrated into the concrete and floors, whereby the building mass is activated. This is optimal for the thermal indoor climate, and in addition peak loads can be reduced substantially, as a part of the cooling needs are shifted to the non-occupied night hours when the building's thermal mass is cooled down.

In office buildings, the need for cooling is often much greater than that for heating. A major advantage of radiant cooling is the possibility to integrate free cooling sources for example in the form of ground water, sea or lake water. Combined with a radiant cooling system this can reduce the energy consumption for cooling as traditional chillers can be eliminated, and only electricity for circulation pumps is needed. Also with conventional cooling technology such as traditional roof top chillers, a radiant system will potentially yield energy savings.

In particular when using thermally active building system, it is possible to run the system during periods when the building is unoccupied. The system utilises the concrete's thermal mass storage and discharge of thermal loads. This conserves energy by reducing the load on traditional HVAC systems and allows using off-peak energy rates for lower operation costs.

Minimizing losses

In addition to a building's net heat requirements there will typically be a loss of up to 20% from the total heating system. This additional loss can be assigned to boilers, pumps, control, distribution, emissions, etc. Emission losses depends on the choice and positioning of heat emitters (under floor heating, radiators etc.) and the system's ability to maintain an optimum temperature profile and compensate for changes in heat demand over time.



This airport in Bangkok provides cooling and thermal comfort by combination of two separate systems: a displacement ventilation system with variable flow volume and an underfloor cooling system supplied by Uponor.

A significant portion of these system losses can be minimized by proper design and layout of system parameters such as emitter location in the construction, pipe spacing and dimensions. There are also significant savings to be gained through developing and implementing dedicated control algorithms. For example, Uponor has developed a self-learning control algorithm for floor heating systems based on pulsed heat input, which virtually eliminates control loss with a documented annual energy savings of up to 8%.

Conclusion and perspectives

A radiant heating and cooling system makes commercial buildings more energy-efficient, also when it is paired with a traditional HVAC system. The radiant system works with water temperatures close to the ambient temperature, which allows low-exergy design, resulting in reduced primary energy consumption. In order to utilise our energy resources in an optimal way, it is suggested that integrated low temperature water-based systems are a key element in the future construction design practice and energy system design. Thermal comfort with minimum energy consumption can be achieved using radiant heating and cooling systems in combination with appropriate conditioning of the indoor air. Heating can be provided at optimal efficiency using large emitters with temperatures close to ambient and the cooling loads can be efficiently removed at favourable temperature levels by using free cooling sources with a ground coupled heat pump. **3E**

Phase change materials

Energy analysis of a complex heating system with PCM thermal storage in different climatic conditions



Uroš Stritih

Doc. dr.
University of Ljubljana, Slovenia
uros.stritih@fs.uni-lj.si



Andreja Burkeljca

d.i.s.
University of Ljubljana, Slovenia
andreja.burkeljca@fs.uni-lj.si



Vincenc Butala

REHVA Fellow
Prof. dr.
University of Ljubljana, Slovenia
vincenc.butala@fs.uni-lj.si

Abstract

An energy analysis of the complex heating system for heating of buildings, consisting of solar collectors (SC), latent heat storage tank (LHS) and heat pump (HP) was performed. The analysis was made for the heating season within the time from October to March for different climatic conditions. These climatic conditions were defined using test reference years (TRL) for cities: Ljubljana, London, Rome and Stockholm. The energy analysis was performed using a program which allowed hourly dynamics calculation of losses and gains for a given system. It was found that the system could cover more than 50% of energy from the sun and the heat pump coefficient of performance (COP) reached 6.

Introduction

Buildings share of total energy consumption is estimated of about 40%. The buildings sector is increasing and this consequently also increases energy consumption. Because of this reason a reduction of energy consumption and use of energy from renewable sources represent important steps towards reduction of greenhouse gas emissions. Measures to reduce energy consumption

could be the increased use of energy from renewable energy sources respecting the Kyoto Protocol and to meet both long-term commitment to maintain the global temperature rise below 2°C as well as a commitment that by 2020 total greenhouse gas emissions must be lower at least 20% and meet the requirements of the EPBD 2010/31/EU [1].

Reduced energy consumption and increased use of energy from renewable energy sources play an important role in promoting security of energy supply. One of the promising alternatives for heating is solar energy. The best way to store solar energy is heat storage device.

Energy storage in tanks can be integrated into various systems. One way is the integration in a heating system. A combination of tank and combustion of biomass gives an optimal performance because the heat which is not used for building heating is stored in heat storage and can be used for heating when the heating device does not work [2].

Sizing principles for sensible heat storage device, which is integrated into the heating system, are purposed by Viorel Badescu [3]. He presented two models. The results show that the smaller heat storage devices cool faster than larger ones and that the thermal energy stored per month and monthly energy used to drive the heat pump compressor increases with increasing length of the tank. Of course it is possible to integrate the storage device into the building. In this case heat storage device can have three working modes: charging with heat, heat discharging (while emptying) and contemporary charging and discharging. Such heat storage device with alcohol as working medium in termosifone gives the best results [4].

The media, used for filling heat storages devices are different. One possible medium for heat storing are substances that change the physical state (Phase Change Materials - PCM), which can be used in different systems for both heating and cooling. They are very suc-

cessful in reducing the energy requirements of buildings [5]. Unfortunately, before their widespread use is necessary to solve many problems on research and development level. Above all a lot of attention must be paid to thermal characteristics of PCM [6].

Latent heat storage is becoming increasingly important. The use of latent heat storage in buildings has some advantages. By using the proper PCM and its proper installation latent heat storage devices can be economically efficient in heating and cooling of buildings. For mass use, it is necessary to solve some problems of reliability and practicality [7]. Over the past twenty years PCM and energy storage has been and important subject for research. Review of publications on thermal energy storage using a solid-liquid phase change was made by Zalba and other authors [8].

Energy storage can be carried out according to the melting/solidification characteristics of PCM. For the base three different types of paraffin with different melting temperatures were taken. The impact of Reynolds and Stefan number on melting and solidification of PCM was determined [9]. In analysing the behaviour of PCM - paraffin in capsules was found that the phase change occurs in the temperature interval. Use of enthalpy method showed that the melting process depends mainly on the size of the Stefan's number, the temperature at which phase change occurs and the diameters of capsules [10]. Latent heat storage devices can be used in heating systems together with solar collectors and heat pump. Simulation was performed for the system with latent heat storage device with measurements of inlet and outlet temperature of latent heat storage device filled with PCM [11]. In such a system some design factors are important for the performance of the system [12]. Design factor can be for example fins on heat storage device. A comparison was made between a flat heat storage device and a heat storage device with fins. It turned out that in the heat storage with fins PCM melting time was reduced [13].

Much interest in the last ten years was also attracted by sorption and thermochemical heat storage devices. In

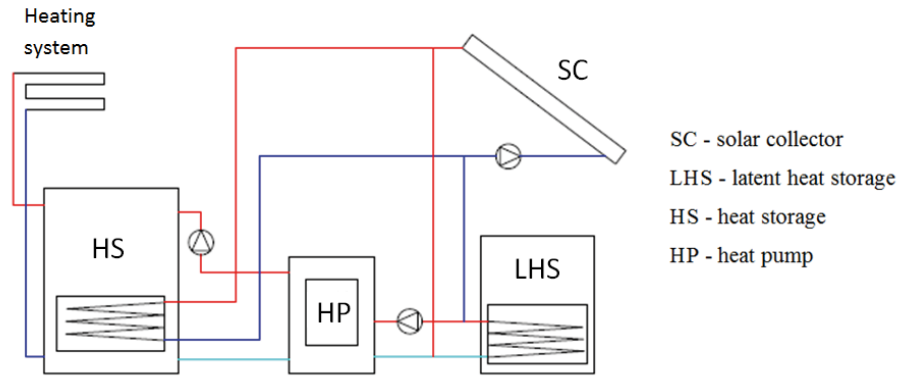

Figure 1. Scheme of the heating system.

this area some project concerning absorption and adsorption heat storage devices are carried out. Their use is limited due to high prices of materials. The advantage of this technology is the possibility of long-term heat storage [14].

Description of the system

Solar radiation is a sustainable source of energy. The annual amount of solar energy that falls on Earth is more than eight thousand times larger than the annual global demand for primary energy.

Local distribution of the total annual amount of solar energy is determined by climatic and meteorological factors that are highly dependent on their location.

For exploitation of solar energy a system composed of solar energy collector, low-temperature (latent) heat storage device, heat pump and heating system, which is linked to heat storage device, can be used. System is presented in **Figure 1**.

Functioning of the system:

Solar energy collector absorbs solar energy, which is then transmitted by the heat exchanger to the latent heat storage device, which is filled with a phase changing material (PCM) - paraffin. The phase change material store energy in the process of changing in their physical state from solid to liquid. In our case the melting temperature was 30°C.

Thermal energy is then used by the heat pump from the latent heat storage device to a higher temperature level. This energy is stored in heat storage device and then sent through a heat exchanger into the heating system which is used for heating of building. In this way a space temperature of 20°C can be provided. The temperature of the heating system is 40°C.

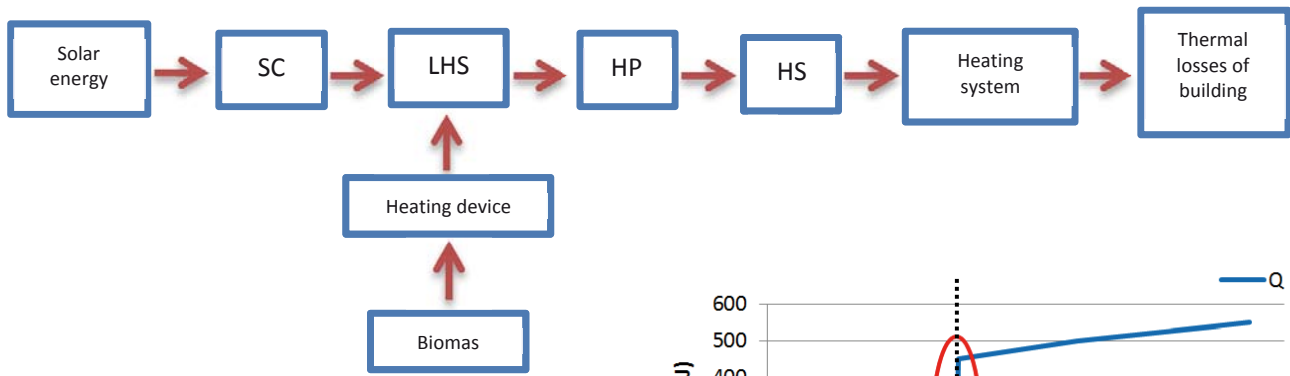

Figure 2. Scheme of the calculation.

Mathematical model

In analysis of complex heating system a computer program - application that allowed simulation of behaviour of the heating system in different climatic conditions was used. To implement the simulation input data were: hourly solar radiation, the corresponding external temperature, characteristics of the solar energy collector, latent heat storage device filled with paraffin Rubitherm RT 31, heat pump characteristic and low-energy house characteristic. For weather data Test Reference Year (TRY) was used.

The calculation scheme is presented in Figure 2.

The following are the physical parameters of the system components:

- Solar energy collector - (SC).

The solar energy collector is designed to convert solar energy into heat. In analysed system two solar collectors were used. The characteristic of each collector is presented in Table 1.

Table 1. Characteristic of the solar collector.

F'	A_{SC} [m ²]	$G_{glob,\beta}$ [W/m ²]	T_{cover}	α_{abs}	U_{SC} [W/m ² K]	T_{mid} [K]
0.95	25	500	1	0.95	1.5	30

The amount of heat generated by the sun is calculated using Equation 1.

$$Q_{SC} = F' \cdot A_{SC} \cdot [G_{glob,\beta} \cdot \tau_{cover} \cdot \alpha_{abs} - k U_{SC} \cdot (T_{mid} - T_{amb})] \quad (1)$$

where:

- F' Dimensionless efficiency factor of the absorber
- A_{SSE} Solar energy collector area (m²)
- $G_{glob,\beta}$ Global solar radiation in the plane of the collector cover (W/m²)

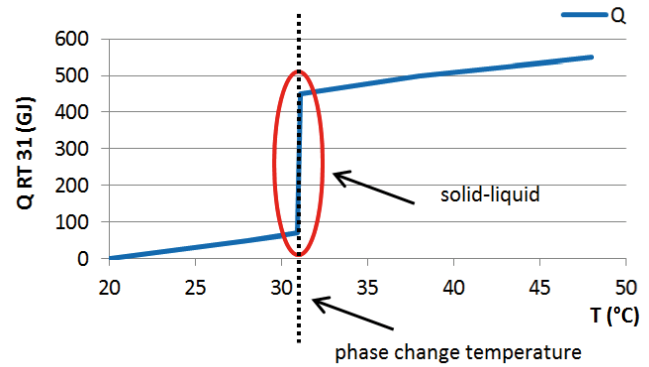

Figure 3. Temperature distribution in the latent heat storage device with RT 31.

- τ_{cover} Transitivity of the solar energy collector cover
- α_{abs} Absorptivity of solar radiation on the absorber
- U_{SC} Thermal conductivity of the solar collector (W/m²K)
- T_{mid} Mean temperature of the liquid in the collector (K)
- T_{amb} Ambient temperature (K)

- Latent heat storage (LHS) with paraffin Rubitherm RT 31

For energy storage at low temperature level, we have used latent heat storage with paraffin Rubitherm RT 31 with following characteristics:

Table 2. Characteristic of paraffin RT 31.

$C_{p\ solid}$ [kJ/kgK]	$C_{p\ liquid}$ [kJ/kgK]	ρ_{solid} [kg/m ³]	ρ_{liquid} [kg/m ³]	$T_{melting\ point}$ [°C]
1.8	2.4	880	760	31

Characteristics that paraffin have is that they store a greater amount of energy without changing their temperature at phase change (solid - liquid and vice versa) as shown in Figure 3. In this case the temperature at which the phase change occurs was 31°C.

- Heat pump (HP)

The role of heat pump in the heating system is to raise the thermal energy from a lower temperature level to

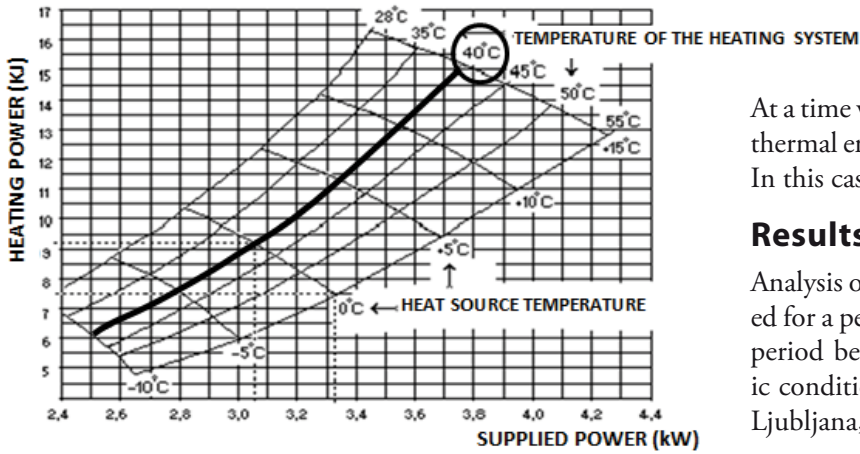

Figure 4. Diagram for determining COP.

a higher temperature level. COP (coefficient of performance) of heat pumps have been calculated using **Equation 2** for each heat source temperature according to **Figure 4** for the output temperature of the heating system (water flow) of 40°C. The temperature of the stored heat source in a latent heat storage device has varied depending on solar gains.

$$COP_{heating} = \frac{Q_C + P_{HP}}{W_{HP}} \quad (2)$$

where:

- COP_{heating} Coefficient of performance for heating
- Q_C Heat from a heat source (kWh)
- W_{HP} Heat pump supplied energy (kWh)

- Low energy building

The installed system was used for heating of low energy building with the following characteristics:

Table 3. Characteristics of low energy building.

A [m ²]	U [W/m ² K]	T _i [°C]	T _{sys} [°C]
150	0.4	20	40

Calculation of the losses has been made by the **Equation 3**.

$$Q_{loss} = A \cdot U \cdot (T_i - T_e) \quad (3)$$

where:

- Q_{loss} Heat losses (kWh)
- A Building envelope area (m²)
- U Overall thermal transmittance of building (W/m²K)
- T_i Internal temperature (K)
- T_e External temperature (K)

At a time when the sun was not able to provide sufficient thermal energy secondary heating system is switched on. In this case the biomass boiler.

Results and analysis

Analysis of a complex heating system has been conducted for a period of heating season, which we define as the period between October and March. Data on climatic conditions have been obtained for the cities: Rome, Ljubljana, London and Stockholm.

The analysis showed that the maximum solar gains through the entire heating season are highest in Rome, the lowest in Stockholm, where during the months November, December and January they are almost zero. Most solar gains for all cities are obtained in March (**Figure 5**).

Heat losses in the heating season are the largest in Stockholm, and the smallest in Rome. For all the considered sites maximal losses are in January (**Figure 6**).

Figure 7 presents data of heat obtained with a heat pump by month during the heating season. From the diagram we can see that it is possible to get more heat in March. This fact is linked to a sufficient amount of sun energy during this month.

In given location the maximum possible average gain of heat for heating is in Rome. Maximum heat gain can be achieved in Ljubljana in March, but the lowest results are in Stockholm in November, December and January.

Efficiency of the heat pump or coefficient of performance (COP) gives us the ratio between produced heat and input energy (electricity). In the presented system COP reached values during the heating season between 0 and 5.69. Value of 0 means that there was no heat source from which heat pump could draw the heat, and raises it at a higher temperature level.

As presented in **Figure 8**, the value 0 was reached in Stockholm in December and January. The maximum value of COP is 5.69, which was reached in Rome, Ljubljana and London. In Rome this value was reached in the months October, November, February and March, in Ljubljana in October and March and in London in the months of October and March. In Stockholm, the maximum value of COP was 5.12.

Because through the all heating season there is not enough sun for heating and in consequence reheat-

articles

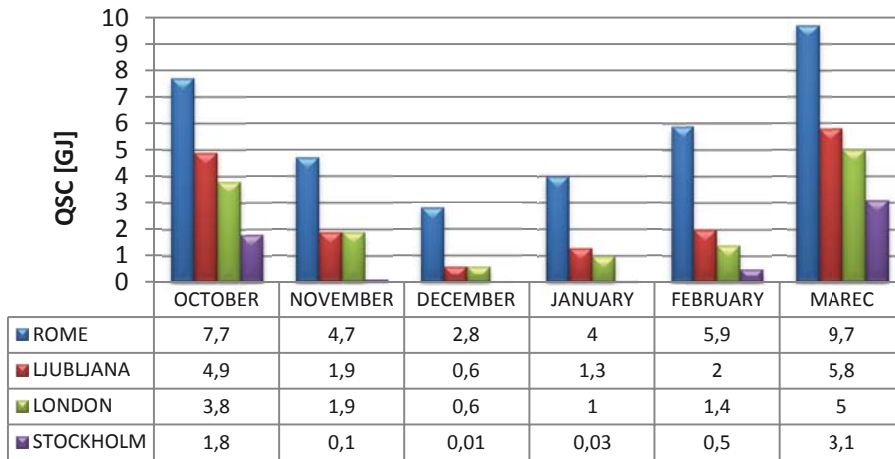

Figure 5. Solar gains during the heating season - Q_{sc}

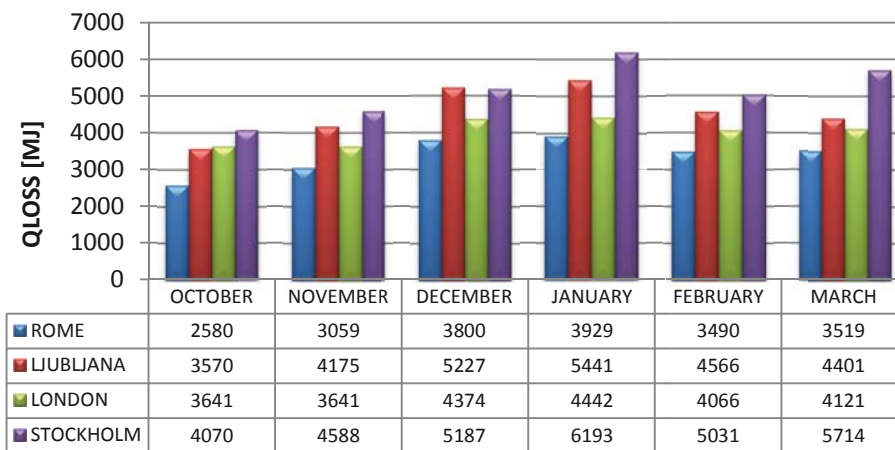

Figure 6. Heat losses during the heating season for the concerned city - Q_{loss}

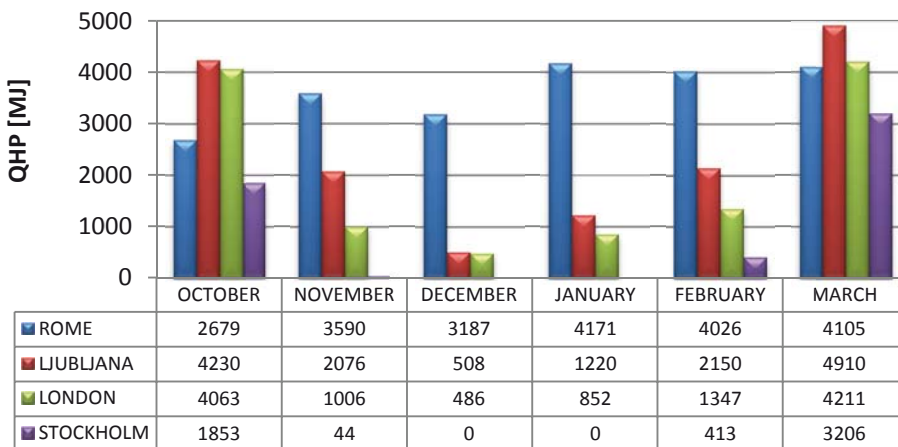

Figure 7. Heating with a heat pump in the heating season for the concerned city - Q_{HP}

ing is needed. As a secondary source of heat biomass has been chosen. As shown in **Figure 9** the greatest need for the latter is in Stockholm. It is necessary through all the heating season. In Ljubljana, reheating is not required in the month of October, the highest value is reached in Stockholm in January. Through the heating season, the reheating is necessary at lower rates in Rome.

Conclusion

Because of unsustainable use of organic fossil fuels on which the energy supply of mankind relies, it is necessary to introduce advanced technologies for heating. Among the environmentally friendly technologies that are used for heating solar energy is one of them. Solar energy in combination with a heat pump and a latent heat storage device represents an economical and efficient heating system.

To the economy of this system contributes its geographical position in first place because of the following reason: more we move towards the equator, more solar energy is available and vice versa. When solar energy does not provide sufficient thermal energy to cover losses of the building we need reheating. In this case the heating system becomes less economical, since reheating is payable and solar energy is free of charge. With this kind of system one can use solar energy to provide approximately 50% of the annual heat requirements for a low energy house. The amount of sun also has an impact on the coefficient of performance (COP) of heat pump. In accordance with the geographical position the latter can reach a value of nearly 6.

References

[1] Directive 2010/31/EU of the European Parliament and of the Council of 19 May 2010 on the energy performance of buildings (<http://eur-lex.europa.eu/>).

[2] U. Stritih, V. Butala, Optimization of a thermal storage unit combined with a biomass boiler for heating buildings, *Renewable Energy* 29 (2004) 2011-2022.

[3] Viorel Badescu, Model of a thermal energy storage device integrated into a solar assisted heat pump system for heating, *Energy Conversion and Management* 44 (2003) 1589-1604.

[4] Mao-Ching Lin, Lin-jye Chun, Wen-Shing Lee, Sih-Li Chen, Thermal performance of a two-phase thermo syphon energy storage system, *Solar energy* 75 (2003) 295-306.

[5] Vincent Veer Tyagi, D. Buddhi, PCM thermal storage in buildings: A state of art, *Renewable and Sustainable Energy Reviews* 11 (2007) 1146-1166.

[6] Murat Kenisarin, Khamid Mahkamov, Solar energy storage using phase change materials, *Renewable and Sustainable Energy Reviews* 11 (2007) 1913-1965.

[7] Yinping Zhang, Goubing Zhou, Kunping Lin, Qunli Zhang, Hongfa Di, Application of latent heat thermal energy storage in buildings: State-of-art and outlook, *Building and Environment* 42 (2006) 2197-2209.

[8] Belen Zalba, Jose M. Martin, Luisa F. Cabeza, Herald Mehling, Review on thermal energy storage with phase change: materials, heat transfer analysis and application, *Applied*

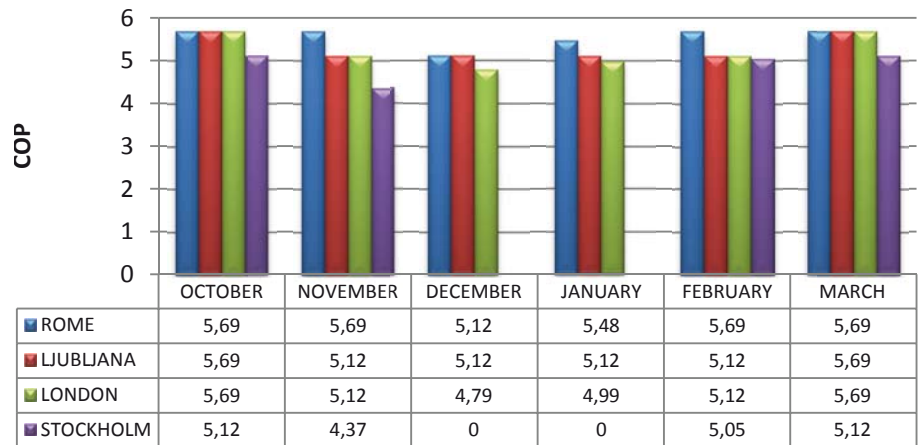

Figure 8. Maximum COP values during the heating season.

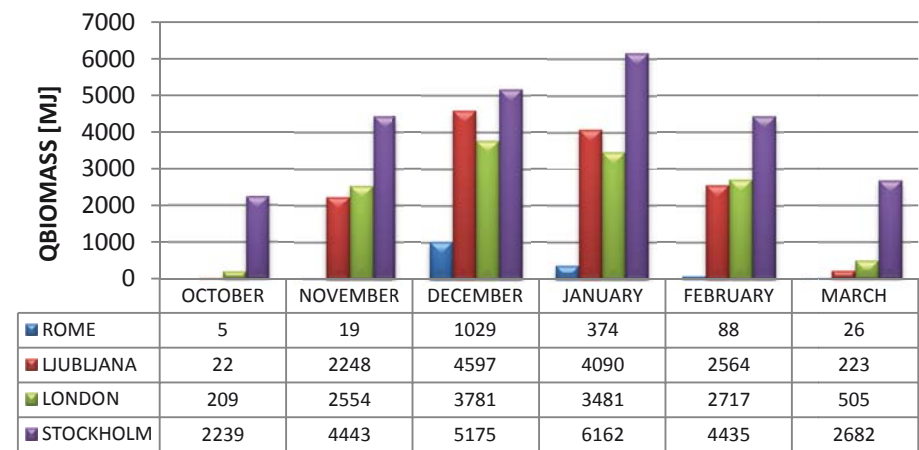

Figure 9. Additional heating with biomass in the heating season for the concerned city.

Thermal Engineering 23 (2003) 251-283.

[9] Mithat Akgun, Orhan Aydin, Kamil Kajgusuz, Thermal energy storage performance of paraffin in a novel tube-in-shell system, *Applied Thermal Engineering* 28 (2008) 405-413.

[10] A. Felix Regin, S. C. Solanki, J. S. Sami, Latent heat thermal energy storage using cylindrical capsule: Numerical and experimental investigations, *Renewable Energy* 31 (2006) 2025-2041.

[11] M. Esen, Thermal performance of a solar-aided latent heat store used for space heating by heat pump, *Solar Energy* 69 (2000) 15-25.

[12] Omer Comakli, Mahmut Bayramoslu, Kamil Kajgusuz, A thermodynamic model of a solar assisted heat pump system with energy storage, *Solar Energy* 56 (1996) 485-492.

[13] U. Stritih, An experimental study of enhanced heat transfer in rectangular PCM thermal storage, *International Journal of Heat and Mass Transfer* 47 (2004) 2841-2847.

[14] K. Edem N'Tsoukpoc, Hui Liu, Nolwenn Le Pierres in Lingai Luo, A review on long-term sorption solar energy storage, *Renewable and Sustainable Energy Reviews* 13 (2009) 2385-2396. ☞

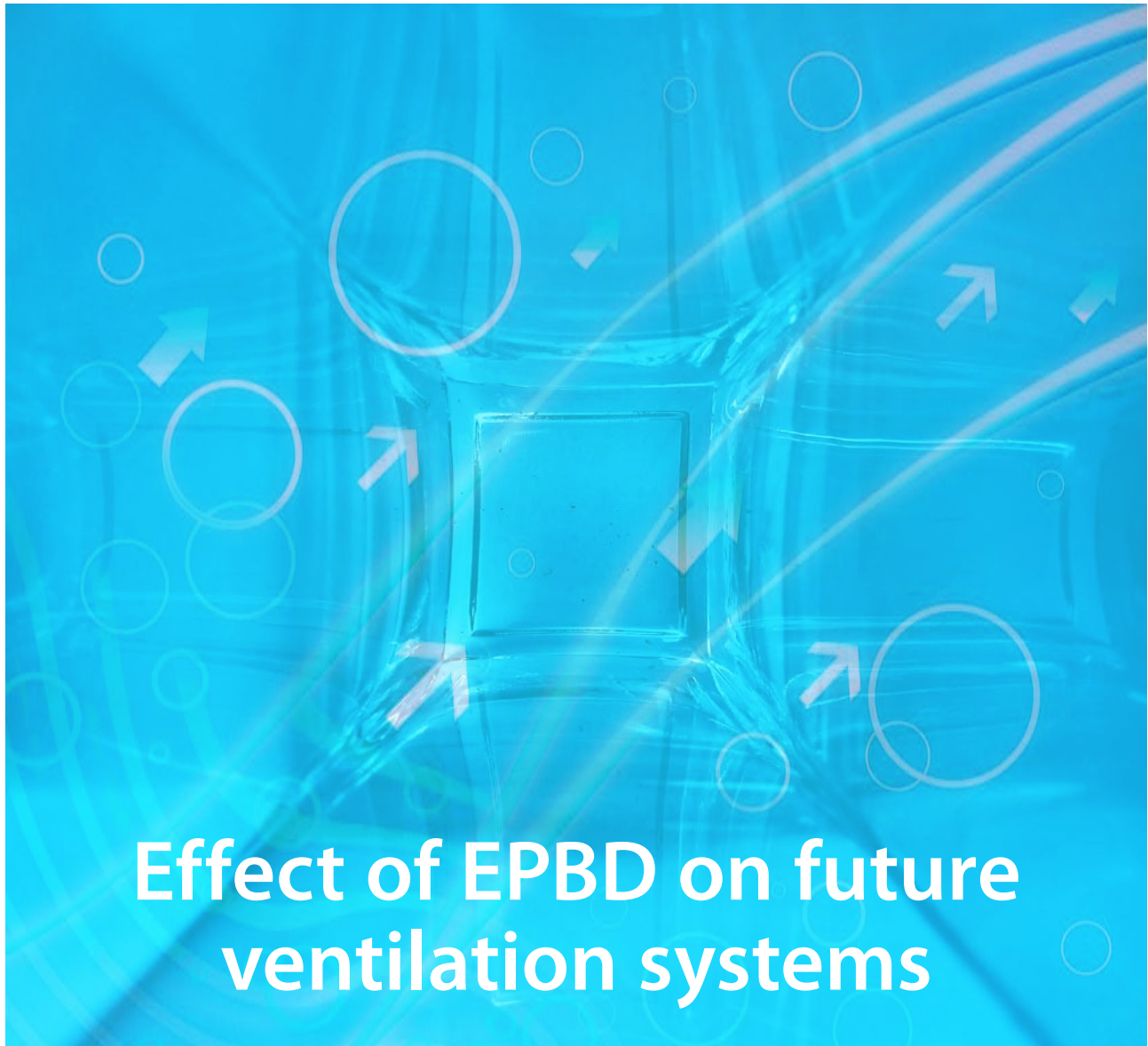

Effect of EPBD on future ventilation systems



Olli Seppänen
REHVA Fellow
Secretary General
REHVA

Introduction

In 2010, the EU adopted recast of the Directive on Energy Performance of Buildings (EPBD) (EC, 2010). This directive is a recast of an original EPBD directive from 2002 (EC, 2002). Among others, it sets more stringent requirements for insulation properties of building envelopes and requires that all new buildings in the EU to be nearly zero energy by 2020 (EC, 2011). Member States must transpose the directive into national regulations by July 2012.

The directive itself is not descriptive and does not provide any suggestions how to achieve the adopted stringent energy goals. A very worrying scenario is that in order to limit overall building energy consumption, ventilation rates will be reduced to reduce energy use. However, at the same time a considerable amount of evidence links low building ventilation rates with health and comfort problems in building occupants. The implementation of the EPBD recast should not cause a reduction of ventilation rates and consequentially related health and comfort problems for building occupants.

In order to get better understanding on how the latest modifications of the EU legislation on energy use in buildings are expected to affect ventilation practice and indoor air quality information was collected from

a group of experts on ventilation in several European countries.

Questionnaire was focused on how the EPBD recast will influence indoor air quality in buildings and use of ventilation technologies to cope with the stricter goals. The questionnaire comprised of 11 questions with multiple choices for responses.

Results

Data from 17 countries (Bulgaria, Czech Republic, Denmark, Finland, France, Germany, Greece, Hungary, Italy, Lithuania, The Netherlands, Norway, Portugal, Romania, Slovakia, Slovenia, United Kingdom) was received covering geographically all parts of the Europe. The charts presented below provide a review of answers which were provided on the received questionnaires. The reference year for the data is 2011. The question which was presented to the respondents is printed on the top of each pie cart which summarised the responses. The numbers inside the each section of pie chart indicate the national responses in numbers and percentage from the total.

Slightly more than half of the respondents answered that they expect IAQ will increase due to EPBD recast problems to increase (**Question 1**). Some countries suggest that problems will decrease due to the more use of ventilation, which will be required to fulfil EPBD requirements, and because more buildings are expected be better ventilated due to increase in need for heat recovery systems and increase of hybrid ventilation systems over natural ventilation.

Majority national experts expect that regulations on ventilation will be revised (**Question 2**). Most of those who do not expect regulations to be revised have already revised regulations in the past couple of years. Dates of

existing regulations and expected regulations for countries which provided answers are:

- Czech Republic: were revised 2007 for working environment and 2011 for dwellings
- Denmark: will be revised in 2012
- Finland: were revised 2010, in force 2011
- Germany: will stay as today from 2009
- Hungary: will be revised in the end of 2011
- Netherlands: will stay as today from 2003
- Norway: will stay as today from 2007
- Portugal: will be revised in 2012
- Romania: will be revised after new CEN standards are validated
- UK: will stay as today from 2010 until next revisions in 2013/16

Slightly less than half of the respondents think that regulations will be enforced more and slightly less than half think that they will be enforced less (**Question 3**). None has thinks that regulations will be enforced as before.

The most conclusive answer in the whole questionnaire (**Question 4**) is regarding the use of natural ventilation, which will most probably decrease in the future. The second most convincing answer was regarding the use of heat recovery where only two southern European countries answered that they do not expect that more of it will be used. Such answers are expected as both countries have hot climate with little demand for heating. Answers regarding controlled ventilation and hybrid ventilation systems are not conclusive. The question on use of controlled ventilation with mechanical supply and exhaust may indicate that more of it will be used in the future.

Vast majority agrees that requirements on envelopes of building will get tighter (**Question 5**). Only two countries expect that tightness will stay as before (those coun-

Q1) Will IAQ problems increase or decrease with recast EPBD?

- increase
- decrease

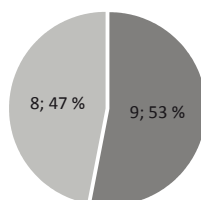

Q2) Regulations on ventilation will be revised to become more stringent or stay as they are?

- Regulations will be revised
- Regulations stay as before

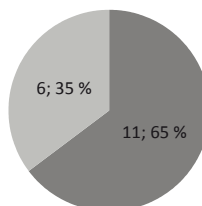

Q3) Regulations will be enforced more or as before?

- more
- as before

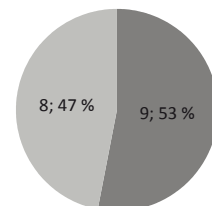

Q4) The following changes will take place in ventilation systems:

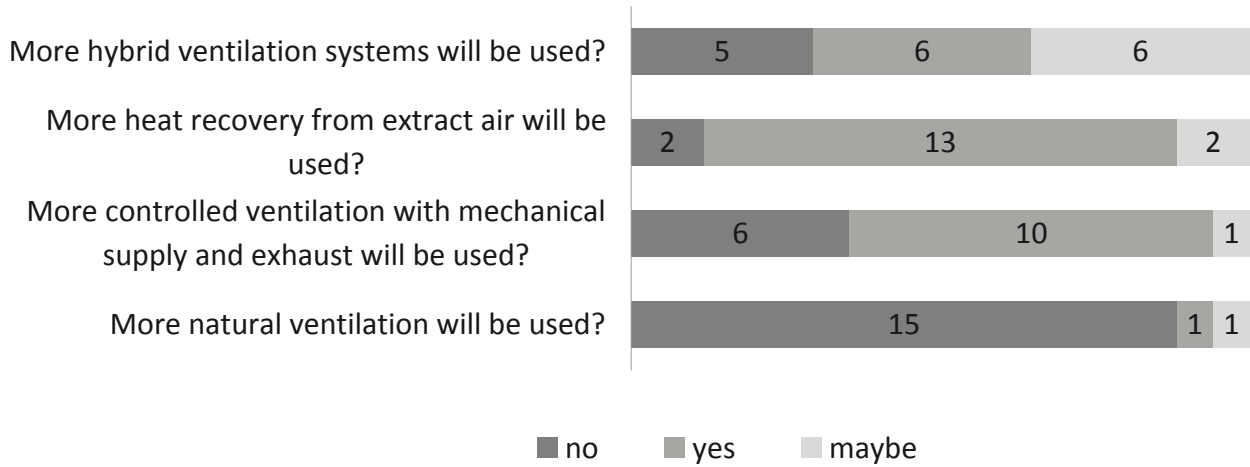

Q5) Envelope of the building will become more airtight, more leaky or stay as before?

■ tighter ■ as before

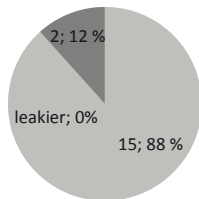

Q6) Indoor air of nearly zero energy buildings will get enough or too little attention?

■ enough ■ too little

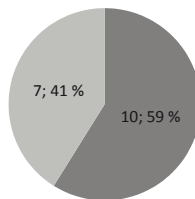

Q7) Requirements for IAQ will be included in regulations?

■ yes ■ no ■ maybe

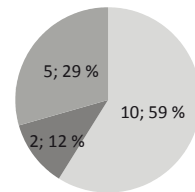

Q8) Are the requirements for indoor air pollutants controlled?

■ no ■ yes ■ partly

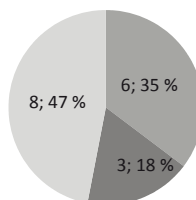

Q9) Do regulations allow lower vent rates if building materials are less polluting?

■ yes ■ no

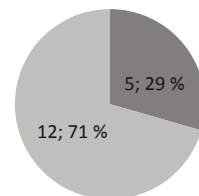

tries have already stringent requirements for airtightness).

Majority of respondents considered that indoor air of nearly zero energy buildings will get enough attention (**Question 6**).

The majority of ca. 60% thinks that IAQ will be included in ventilation regulations (**Question 7**). Additional 30% think that IAQ requirements may be included in their regulations in the future. Only ca. 10% of respondents think that IAQ requirements will not be included in the regulation. It is important to note, that the same respondents also expect that IAQ related problems will increase, IAQ of nearly zero building will get too little attention and that regulations will not be changed. Such an answer suggests that countries which do not intend to change ventila-

tion regulations and include IAQ requirements may face IAQ related problems in the future.

When asked in **Question 8** if the requirements for indoor air pollutants are controlled, slightly less than half with 47% answered “partly”, 35% answered “yes” and only three or 18% “no”. Only two of the respondents

provided additional the explanation to answers “partly” and “yes”.

Majority of countries (71%) do not allow lower ventilation rates if less polluting building materials. However, four countries allow lower ventilation rates in the case of on non-polluting materials used, each country defining this option in a different way:

1. ventilation rates can be reduced based on EN 15251 which is included in national regulations
2. in offices, ventilation rate can be reduced from 2 l/s/m² to 0.7 l/s/m²
3. values given in regulations are for non-polluting materials, designers should increase values by 50% when polluting materials are used
4. ventilation rates in regulations are given for low emission buildings and non-low emission buildings and for many object types, including offices, schools and kindergartens. For all three cases, required ventilation rate for building can be reduced from 2.9 to 1.4 m³/h/m². The regulation does not mention lower ventilation rates in dwellings, where 0.5 is set as a minimum air change rate.

In most countries, ventilation rates cannot be controlled by the outdoor air quality (**Questions 10**). It is also not possible to reduce ventilation rates if ventilation efficiency is improved or if effective room air cleaning is used. On the other hand, heat recovery from ventilation air is required in all countries responding to this question. Possibility to adjust ventilation rates based on pollution loads or needs and demand controlled ventilation are included in regulations of slightly less than half of the responding countries.

All the respondents think that demand controlled ventilation and heat recovery will be used in the future (**Question 11**). The answers are almost uniform also when asked about the possibility to adjust ventilation rates based on pollution loads and need. All except one from nine think that this technology is going to be used in the future. Two thirds of the respondents also think that reducing ventilation rates if ventilation efficiency is improved accepted in the future. Concerning the questions on ventilation rates controlled by the outdoor air quality and reducing the

Q10) Are the following technologies already included in your regulations?

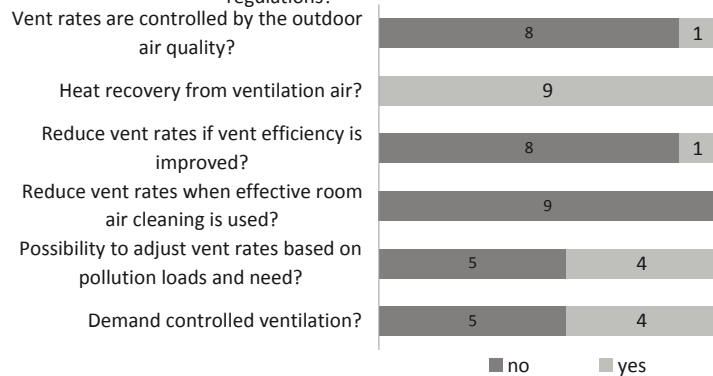

Q11) Do you think that the following technologies will be used in the future to achieve performance requirements of the future local energy regulations?

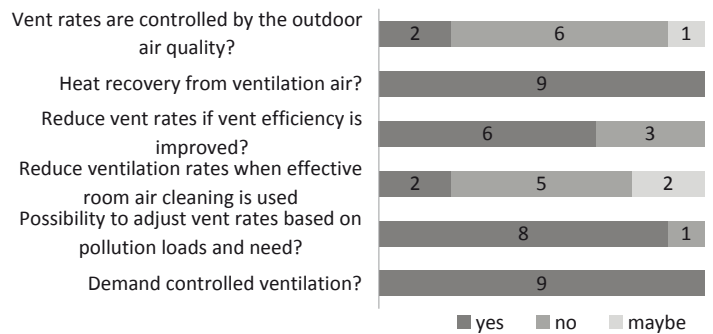

ventilation rates if effective room air cleaning is used, no predictions can be made based on the received answers, as most of the respondents answered “maybe” for both questions.

Summary

The 2010 recast of the Directive on Energy Performance of Buildings (EPBD) requires among others that all new buildings in the EU are built as nearly zero energy by 2020. A very probable scenario is that in order to limit overall building energy consumption, ventilation rates will be reduced.

The following conclusions can be made based on the results:

- IAQ related problems are expected to increase due to the tighter building envelopes and because requirements for the IAQ quality are not included in the EPBD. On the other hand, slightly less than half of the respondents think that IAQ will increase due to revised ventilation

regulation to tackle the IAQ problem.

- Majority of the respondents expect ventilation regulation to be revised in the near future. The rest do not expect their regulations to change soon because they have recently been revised.
- The opinion about the future enforcement of ventilation is split evenly with one half foreseeing regulation to be enforced less and the other half to be enforced more.
- According to the opinion of the majority, the future use of natural ventilation will decrease and the use of heat recovery will increase.
- Building envelopes will almost certainly get tighter.
- Majority thinks that IAQ will be for sure or probably included in future ventilation regulations with only 10% meaning that it will not be included. The analysis of results also indicates that countries which do not intend to change ventilation regulations and include IAQ requirements may face IAQ related problems.
- Most of the countries do not allow for possibility of reducing ventilation rates if less polluting materials are used and also do not allow to control ventilation rates based on the outdoor air quality.
- Reduction of ventilation rates if ventilation efficiency is improved or if effective room air cleaning is used is also not possible (and is not foreseen) in almost all countries in the survey.
- All the respondents think that demand controlled ventilation and heat recovery will be used in the future. A vast majority thinks that the technology to adjust ventilation rates based on the pollution loads and actual need will be used if the future.
- Two thirds of the respondents also think that ventilation rates will be adjusted with ventilation efficiency in the future.

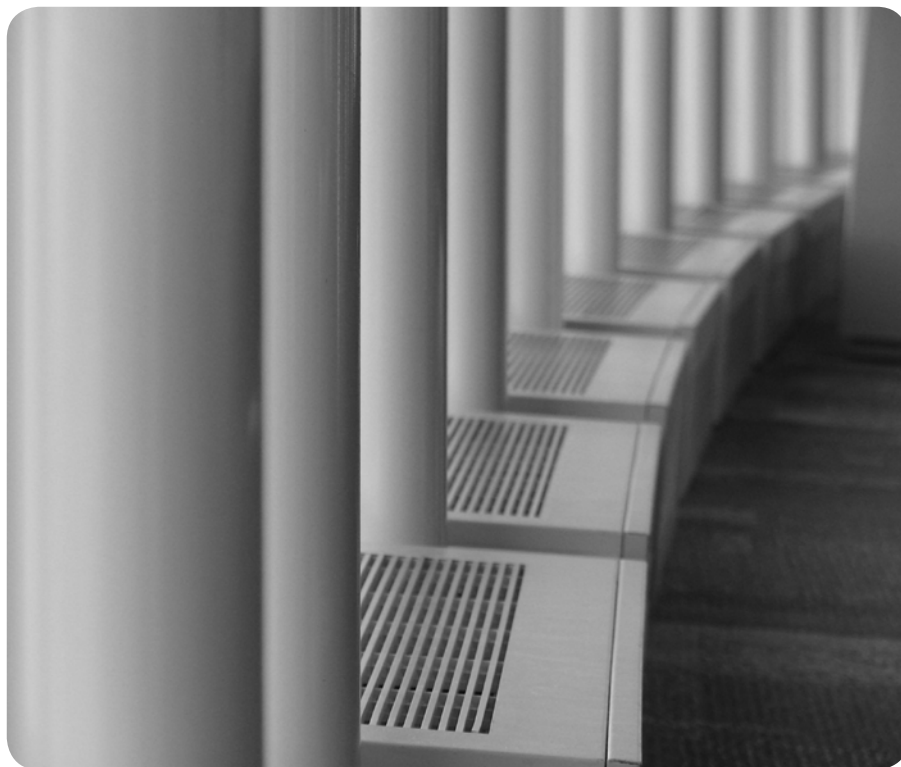

- Use of heat recovery in hot climate is not expected to increase.

Conclusion

Comparison the answers from different European countries does not show any relation between responses and climate, geographic location or construction practice. On the base of answers provided by respondents we can conclude that EPBD recast may have different effects in each European country. One reason for that is the fact that individual countries have currently very different regulations, which will respond to the new EPBD in a different way.

References

- EC (2002). Directive 2002/91/EC of 16 December 2002 on the energy performance of buildings. Retrieved from: <http://eur-lex.europa.eu/LexUriServ/LexUriServ.do?uri=OJ:L:2003:001:0065:0071:EN:PDF>
- EC (2010). Directive 2010/31/EU of 19 May 2010 on the energy performance of buildings (recast). Retrieved from: <http://eur-lex.europa.eu/LexUriServ/LexUriServ.do?uri=OJ:L:2010:153:0013:0035:EN:PDF>
- EC (2011). European Commission - Europe 2020. European Commission - Europe 2020. Retrieved from: http://ec.europa.eu/europe2020/index_en.htm 

Air-conditioning is not an energy guzzler!

Air-conditioning systems across the globe are largely powered by Electricity. One unit saved is one unit produced. Higher performance will result in saving.



D. Nirmal Ram
Chairman Acrex India 2012
Email: dnirmalram@acrex2012.com

Strategies

There are three fundamental strategies to increase energy performance:

- 1) Reduce Demand
- 2) Harvest Site Energy
- 3) Maximize efficiency

Demand reduction is accomplished by challenging initial use assumptions and by reducing internal loads and gains through the shell and lighting improvements.

Harvesting site energy includes using free resources such as daylight, ventilation cooling and solar heating to satisfy needs for space air-conditioning.

Finally the efficiency of the HVAC system should be maximized.

Orientation

The location of the building with reference to the compass points and avoiding exposure on West and East will result in an economical HVAC Design.

Ventilation

A demand controlled ventilation using CO₂-sensors controlling the dampers which in turn controls the Variable frequency drives for changing the speed of the blower will result in higher energy efficiency. For higher outdoor air quantity, heat recovery by means of heat recovery wheel, Run around coils and heat pipe will result in lesser system capacity.

Inside design conditions

Comfortable temperature is a relative figure and depends on outside temperature and humidity. Selecting a lower temperature than comfortable temperature is direct waste of energy. So compromise the need to use low temperature and humidity.

case studies

Equipment selection

Generally it is found that equipment selected on the actual instantaneous peak heat gain is oversized and therefore capable of maintaining much lower room conditions than the original design. One reason for such is the non-simultaneous occurrence of the peak in the individual loads (diversity) Also, if a smaller system is selected, and is based on the extended periods of operation at the peak load, it results in a more economical and efficient system at partially load condition.

Hybrid chilled water system

A hybrid chiller option with a combination of air cooled screw chillers, water cooled centrifugal chillers and absorption chiller with heat recovery boilers from DG sets will enable efficient operation.

Air handling units

Choice of Air handling units with supply and return/exhaust air fans will result in energy saving. During 'free cooling' conditions when the ambient temperature is comfortable, the supply fan will be drawing all outside air, whereas the return/exhaust fan will be exhausting the air from the conditioned area.

Toilet exhaust fans can be hooked with an infrared sensor/timer which will facilitate operation only during occupancy.

Server rooms and data center which are required to function round the clock can be contemplated with dual fluid precision units.

Chilled beams

Chilled beams offer a quiet indoor air free from draught.

Variable air volume units

Variable air volume units coupled with motion sensors will enable closure of the units to the minimum levels will result in energy efficiency.

Ducting

Size ductwork appropriately and install balancing dampers to reduce velocity losses. Ducts with lower aspect ratios offer lower resistance and can reduce fan energy significantly. Ducts should be insulated and sealed but indoor air quality issues should also be considered. Factory made ducts with good workmanship will result in the low leakage losses.



The lotus (*Nelumbo nucifera*) flower is the national flower of India. To Hindus and Buddhists it is a sacred symbol of enlightenment.

Thermal storage

Power tariffs and rationing during peak load hours - This becomes a potential tool for use by the designer to harness the sleeping giant of thermal storage. Thermal storage systems become handy in areas wherein due to water shortage the usage of water cooled chillers are limited.

Vapour absorption system

Alternate sources of energy particularly waste steam/heat can be used for refrigeration. Heat recovery from solar heat is also a possible option.

Variable speed drives

Variable frequency drives can be used for the primary and secondary chilled water circulation pump sets by sensing the temperature and pressure differential in the chilled water lines. Two way motorized valves in the air handling units can be actuated by a thermostat which will vary the flow according to the loads resulting in pressure changes which can be sensed and used for changing the speed of the pump sets.

Variable speed drives are used for the air handling units. Variable air volume units will regulate the airflow for various zones based on the occupancy and temperature by a variable air volume unit, which will give a pressure signal for the VFD to change the speed of the air handling unit.

A demand controlled ventilation system uses a variable speed drive operating based on the opening and closure of the fresh air dampers controlled by the CO₂-sensors.

A typical basement exhaust system can use a variable speed drive controlled by CO-sensors.

Centrifugal/screw chillers with variable speed drives are also available.

Building automation system

The main objective of the building automation system is to reduce the running and energy costs, improve

the quality and supply of information on the air-conditioning system. The system can establish basis which will be good bench mark for energy efficient operation subsequently.

Good installation practices

A good equipment will not serve its purpose if it is not installed properly. Good installation practices with stringent quality control measures will result in easy main-

Case study:

Energy efficient HVAC system for an IT park, Bangalore

Project name: Pritech 2 Sez Park, Bangalore. Commissioned on December 2008

The project involves air-conditioning of Software and Hardware Park, Pritech 2 SEZ having an air-conditioned floor area of 116,043 sq.mt having three blocks namely block 5, 6 & 7. To cater to the air-conditioning needs a combination of water cooled centrifugal, air cooled screw and vapour absorption chillers are contemplated. 3 Nos Water cooled centrifugal chillers each having a capacity of 700 TR (2462 KW), 10 Nos air-cooled screw chillers each having a capacity of 350 TR (1231 KW) and 1 no vapour absorption chiller using waste heat from Diesel Generating Set/Diesel/Compressed Natural gas totaling to a capacity of 6300 TR (22150 KW) are envisaged. All chillers excepting the vapour absorption chillers are installed. The hybrid chiller combination with water cooled centrifugal chiller will use recycled water from Sewage Treatment plant and will run when the ambient is hot, the air-cooled screw chillers again with a combination of High and Normal Efficiency (5 nos of each type) will run during the periods of low/medium ambient temperatures while the vapour absorption chiller is mainly designed to run during the periods when DG sets are functional recovering the waste heat. This hybrid combination strike a perfect balance between energy efficiency and first and running costs. No standby chillers are envisaged owing to multiple chillers with multiple compressors. Further there is no separate critical chiller system (for 24/7 operating areas) as the same set of chillers can cater to the critical needs also thereby simplifying the chilled water distribution system. The chillers are located in the Utility block having the Lower level with DG sets, Middle level with pump sets and water cooled centrifugal and absorption chillers, intermediate level for chilled water and condenser water piping system and the upper level with air-cooled chillers and cooling towers. The Chiller platform is of RCC construction



(compared to conventional metallic structure) which has a longer life span with no rusting/maintenance and lower first cost. The chiller power apportioning is using the state of the art ultrasonic BTU meters with software programming done to the exclusive need of the project. The BTU meters are protected from misuse/faulty operation by communicating the failure through mobile phones.

The system is being hooked with the phase 2 system with another Chiller Plant room with a ring main concept making the system totally failure free and free from sabotage if any thereby offering the combined advantages of the central chilled water and individual chilled water system

Chilled water circulation is with primary and variable secondary pump sets with two way motorized valves for the Air-handling units. The system provides installation of air-handling units and air distribution system by the tenants.

case studies

tenance and will pave a way to energy saving. Air leakage if any in the ducting system will result in serious energy loss.

Commissioning and handing over

Commissioning is a systematic process to ensure that the air-conditioning system performs according to the design intent and the owner's operational needs. Commissioning maximizes energy efficiency and there-

by minimizes environmental impacts associated with energy production and consumption.

Operation and maintenance

A well drawn-out diligent operation and preventive maintenance schedule really saves energy.

Proper maintaining of inside design conditions does not mean that the system is working efficiently as peak load

The facility has won the LEED Platinum rating

Extraordinary features of the System

- Water cooled centrifugal chiller having a COP of 6.38 and an IPLV of 7.51, High performance Air cooled screw chiller having a COP of 3.05 and IPLV 4.56 and Normal Efficiency air cooled Screw chiller having a COP of 2.88 and an IPLV 4.56 – all installed with a space to install 700 TR Vapour absorption chiller using DG waste heat recovered by Heat recovery boiler. All chillers are with ozone friendly refrigerants.
- All chillers were installed in a multi level utility block – Level 1 DG sets, Level 2 Water cooled chillers and pump sets, Level 3 Chilled and Condenser water Headers and Level 4 with air-cooled screw chillers and cooling towers on RCC platform compared to the conventional Metallic structure free from rusting and maintenance and offering a good maintenance.

- These chillers are to be hooked to the Phase 2 HVAC Plant room with a ring main concept offering total flexibility and free from any failure.
- State of the Art Power apportioning with BTU meters with special programming for this project with Auto SMS facility for failure.

Quantifiable and tangible benefits resulting from the innovation.

- There is a first cost saving of 0.6 million Euros with a centralized chilled water system compared to a standalone chiller system installed on the terrace of each blocks (see Annex).
- There is a running cost saving of 60,000 Euros per month with the Hybrid chiller configuration (see Annex).
 - The RCC chiller platform structure has a saving of 24,000 Euros over the metallic structure construction.



will not exist throughout the year and the plant is designed based on the peak load. As such proper preventive maintenance is to be performed for proper upkeep of the system to save electrical energy.

Operation shall be focussed only in areas, which can result energy saving without compromising the design intent. When there is a compromise, it is not a saving but a faulty operation!

Saving is only a relative term. Improvement is possible at every stage on continuous basis and there is no limit for energy saving.

Accompanying article is case study of a project for Energy Efficiency. It won the LEED Platinum rating. **3E**

Annex: Advantages of a combined chilled water system

Advantages of installing the chillers in a service block common for all blocks as against chillers on roof top for individual blocks that has the following advantages:

Saving in running cost

Combination of Water cooled Centrifugal chillers, Vapour absorption chillers and air-cooled screw chillers pumping chilled water into a common header will result in a low KW/TR compared to individual block roof top air cooled chillers.

- Combined KW/TR for chiller combinations located in the service block – 1.166 KW/TR
- KW/TR for air-cooled chillers on the roof top for individual blocks – 1.527 KW/TR

Approximate saving in running cost for 12 hours operation/day for 26 days/month with combined chillers will work out to 60,000 Euros per month.

Further chiller operation after office hours for critical area air-conditioning requirements such as UPS, Server room, Data centre will be economical.

No air-conditioning failure

Since there are multiple chillers in a common plant room, one or more chiller failure will not seriously affect the air-conditioning. In case of individual block air conditioning, failure of 1 or two chillers will affect the air-conditioning.

No chiller/pump noise on the top floor

Since there are no chillers and pumps installed on the roof of the occupied area, there is no issue of vibra-

tion and noise. Further the roof is clear for the cafeteria if any.

Maintenance at a single zone

Maintenance is at a single zone. This will result in lower AMC cost. The saving in AMC cost will work out to approximately 40,000 Euros per annum.

Chiller/pump power apportioning

Air-conditioning cost apportioning from common chiller and pump sets will be done for each tenants based on the actual usage in a scientific manner using BTU meters based on the usage and not on area basis.

Building Automation System

The features of the BAS are as follows:

- Remote switching On/Off of various equipments
- Remote adjustment of set points with levels of control
- Timed and event related functioning of equipments
- Run time equalization and sequencing of equipments
- Centralized alarm and maintenance schedules
- Trip indication status and Trouble shooting history
- Electrical power/capacity evaluation based on temperature of water, water flow, airflow and duration of operation.
- Chiller electrical power and other common services power apportioning to multiple tenants in a scientific way based on the actual usage
- Networking with multiple computers for remote operation at multiple locations.



nZEB office building

Ympäristötalo in Helsinki, Finland

City of Helsinki has taken the exemplary role of the public sector seriously. The latest proof is the Environment Centre building Ympäristötalo completed in last year. It shows the best energy performance of an office building ever built in Finland. Total primary energy use of 85 kWh/(m² a) including small power loads is expected to comply with future nearly zero energy building requirements. The building is also highly cost efficient, nZEB related extra construction cost was only of 3–4%.



Jarek Kurnitski
REHVA Fellow
Sitra, the Finnish Innovation Fund
jarek.kurnitski@sitra.fi

Energy performance

The building has a high quality building envelope, south facades being double facades with integrated PV cells providing effective solar protection at the same time. All the building, except the atrium space, is air-conditioned with effective integrated balanced

Table 1. Simulated energy performance (all values per net floor area).

	Net energy need kWh/(m ² a)	Delivered energy kWh/(m ² a)	Energy carrier factor, -	Primary energy kWh/(m ² a)
Space and ventilation heating	26.6	32.2	0.7	22.6
Hot water heating	4.7	6.1	0.7	4.3
Cooling	10.6	0.3	1.7	0.5
Fans and pumps	9.4	9.4	1.7	16.0
Lighting	12.5	12.5	1.7	21.3
Appliances (plug loads)	19.3	19.3	1.7	32.7
PV		-7.1	1.7	-12.0
Total	83	73		85

ventilation and free cooling system with passive and active chilled beams. All the cooling is from boreholes, which water is directly circulated in air handling units and chilled beams. Heating systems is based on district heating and water radiators. Highly significant energy efficiency measures are large air handling units and ductworks enabling low specific fan power, combined with demand controlled ventilation in most of rooms except cellular offices, and effectively controlled lighting. The simulated energy performance is shown in **Table 1**. On site renewable energy production of 7.1 kWh/(m² a) PV power generation and 10.6 kWh/(m² a) free cooling from boreholes have significant effect on achieved total primary energy value of 85 kWh/(m² a). Typical to nZEB buildings, the highest primary energy component is the small power loads.

Compactness and solar shading

The building has a reasonable compact massing and excessive glazed areas are avoided. The main facade to south is accomplished as a double facade in order to provide effective solar shading and to serve as mounting for PV panels. Window area is 23% of the external wall area, but the double main facade still provides an outlook of a glass building from major direction. The double facade is open from bottom and has motorized ventilation openings on the top. In total there are about 30 motorized openings/windows used for the double facade and atrium excess heat removal and some of them are also used for smoke removal. The openings are to be open when needed (manual control from reception) and they will be closed by weather station control, based on wind, rain and temperature, automatically.

Windows have blinds between panes.

YMPÄRISTÖTALO, CONSTRUCTION YEAR 2011

Construction management	City of Helsinki, PWD-Construction Management (HKR-Rakennuttaja)
Owner	City of Helsinki, Environment Centre
Construction costs	16.5 million € (2 430 €/m ²)
Estimated nZEB extra construction cost	0.5–0.7 million € (70–100 €/m ² , 3–4 %)
Heated net floor area	6 390 m ²
Gross floor area	6 791 m ²
Occupants/ mean occupant density	240 / 25 m ² /person (overall average)
Architect	Ab Case Consult Ltd, Kimmo Kuismanen
HVAC-design	ClimaConsult Finland

TECHNICAL DATA

Outdoor climate data:

Design outdoor temperature for heating -26°C

Design outdoor temperature and RH for cooling 28°C / 50%

Heating degree days (base temperature 17°C) 3 952 degree days

Indoor environmental quality targets:

Indoor air quality

Air flow rate, offices 1.5 l/s per m²

Air flow rate, meeting rooms 4 l/s per m²

Thermal environment

Indoor temperature, heating season 21°C

Indoor temperature, cooling season 25°C

Air velocity, winter 0.14 m/s

Air velocity, summer 0.20 m/s

Lighting

Illuminance level 300/500 lx.

Building envelope:

Window U-value 0.8 W/(m²K)

Window g-value 0.3

Exterior wall U-value 0.17 W/(m²K)

Base floor U-value 0.16 W/(m²K)

Roof U-value 0.09 W/(m²K)

Average U-value of the building envelope 0.259 W/(m²K)

Specific heat loss per net floor area H/A 0.276 W/(K m²)

Air leakage rate at 50 Pa 0.56 ach

case studies

Energy supply

The building is connected to Helsinki district heating system. District heating is used for hot water and space heating through central air handling units and hot water radiators.

All cooling need is covered with free cooling from borehole water. The borehole system consists of 25 boreholes each 250 m deep. A simple borehole cooling system with a circulation pump and a water tank serves both the central air handling units and chilled beam units installed in offices and other spaces. Boreholes are sized to provide 15°C supply design temperature (return 20°C) to the water tank at dimensioning conditions (normally the borehole water temperature is lower). Air handling units' cooling coils and chilled beams

network are sized to 16/20°C design flow temperatures from this water tank.

South facade of the building has a double facade with vertical PV panels and some panels are also installed on the roof. The total installed PV power is 60 kW (570 m²) that provides about 17% of electricity use of the building.

Ventilation and air conditioning system

The building has an air-conditioning system with mechanical supply and exhaust ventilation and chilled beams. There are 3 main air handling units and 4 risers with zone dampers for each floor. Separated exhaust fans for toilets are not used and are replaced with a small 0.5 m³/s air handling unit with rotary heat exchanger. The main large air handling units of 2.4, 4.2 and 4.0 m³/s have heat recovery temperature ratios of 80, 79 and 78% respectively. The rest, smaller air handling units have temperature ratios of 80–81%. Ventilation system is balanced so that design supply air flows equal to design extract air flows.

Outdoor air is filtered and heated or cooled in central air handling units and supplied to rooms. Supply air is heated in the central air handling units partly with heat recovered from extract air and partly with heating coils. When cooling is needed, supply air is first cooled in the central air handling units and then cooled further in the chilled beam units.

Room conditioning solutions

All open-plan and cellular office spaces have room conditioning with active or passive chilled beam units installed in the ceiling, and controlled by



PV installation on the double facade to south serving also as an effective solar shading.

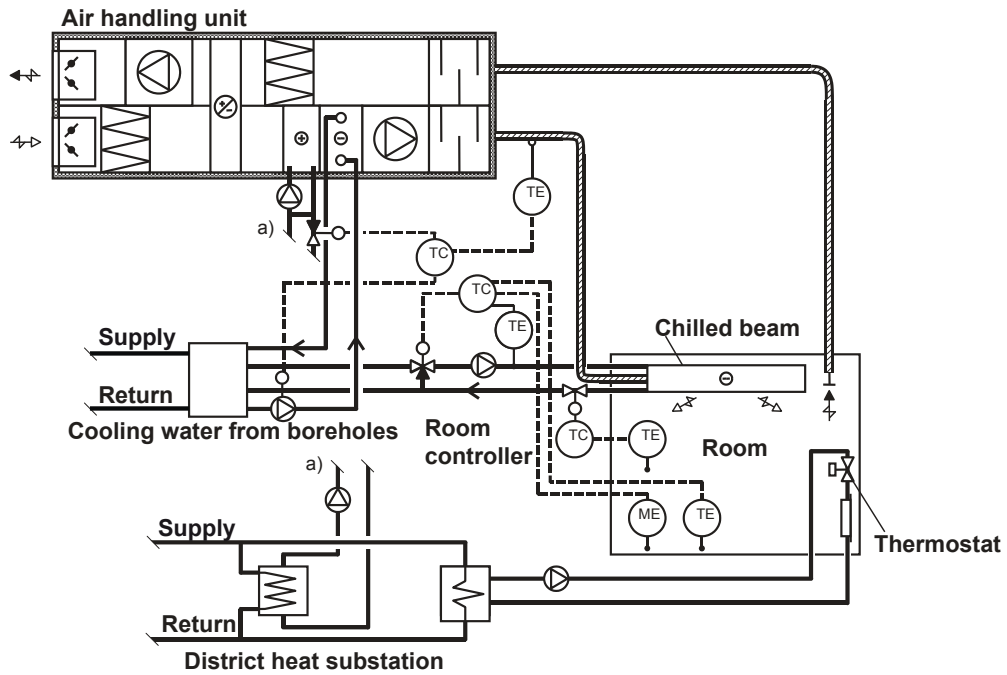

Air conditioning system with mechanical supply and exhaust ventilation and chilled beams.



Large air handling units and ductworks have been used to achieve as low specific fan power as 1.4–1.6 kW/(m³/s) for offices and similar spaces and 1.8 kW/(m³/s) for VAV air handling unit serving meeting rooms.

case studies



Active chilled beams and lighting fittings in offices.

room temperature controllers. Air volume flow rate is kept constant (constant pressure CAV). Rooms are heated with hot water radiators controlled by thermostatic radiator valves.

Active chilled beams are used in cellular offices and passive chilled beams in other rooms. Passive chilled beams allow to use cooling also during nights and weekends when ventilation is switched off. This reduces peak cooling loads to $40\text{W}/\text{m}^2$ that is important in the free cooling system with limited capacity.

Ventilation in the meeting rooms, lobby and workshop areas is controlled by CO_2 and temperature sensors. VAV dampers are used and air flow rates in the meeting rooms are controlled between $0\text{--}4\text{ l}/(\text{s m}^2)$. Office rooms have CAV ventilation of $1.5\text{ l}/(\text{s m}^2)$. The major part of cooling and heating is supplied by the water systems (beams and radiators respectively).

Supply air temperature is extract air temperature compensated and is set between 17 to 22°C . The supply air temperature is controlled by adjusting the rotation speed of the regenerative heat exchanger and the water flow control valves of the heating and cooling coils.

Lighting system

Lighting systems uses lighting fittings of T5 fluorescent lamps with $7\text{ W}/\text{m}^2$ installed power. Daylight, occupancy and time control is used in larger rooms, and occupancy and time control in cellular offices. Lights and chilled beam units have a communication link to building management system (BMS). Outside normal office hours, the BMS sets lights off and lighting demand is controlled by IR motion-sensors.

Key achieved sustainability issues

The best energy performance of an office building ever built in Finland. Total primary energy use of $85\text{ kWh}/$



Atrium space of the building has no installed cooling and overheating is avoided by opening bottom and top windows. Motorized openable windows are to be open manually when needed and will be closed by weather station control (wind, rain and temperature control) automatically.

($\text{m}^2\text{ a}$) including small power loads is an half of a code requirement of $170\text{ kWh}/(\text{m}^2\text{ a})$ and is expected to comply with future nearly zero energy building requirement.

Very good indoor climate quality according to Finnish Classification of Indoor Environment.

Well controlled construction cost of $2\,430\text{ €/m}^2$ is roughly a cost for standard office building in Finland, including only $3\text{--}4\%$ extra energy performance related cost. **3€**

INPAL ENERGIE



INPAL ENERGIE is today increasingly dedicated to heating/cooling network projects from biomass and methanation systems and is specialized in network engineering, pre-insulated pipes and accessories' manufacturing for the transportation of high and low temperate fluids.

INPAL has contributed extensively to the project Poligono Industrial – Zona Franca, exploited by the group Dalkia. Indeed the society won an international tender for the construction and exploitation over 30 years of 3 energy and cooling/heating network power plants in the south of Barcelona. Those plants will produce more than 2.9 million of Megawatt of energy, included 56% of renewable ones.

Dalkia will provide the districts of La Marina, the wholesale market of Mercabarna, the international fair of Gran Via de l'Hospitalet and the City Metropolitana. It will be the first heating/cooling network that offers a service of air-conditioning, intended for domestic use.

« Thanks to a better energy efficiency and the integration of solar thermal systems, the project responds to customers' needs and assures a quality service », explains the Veolia Environment subsidiary (34%) and EDF (66%), which is the European leader of energy services for companies and communities

Thanks to the recommended solution, Dalkia will reduce every year the primary fossil energy consumption by 67 000 MWh – equivalent to a 60 000 inhabitant city consumption and the CO₂ emissions of 13 400 tons a year.

Therefore Dalkia has trusted the Spanish subsidiary INPAL ENERGIA which won the tender as a consortium (UTE) with a Catalan construction company. UTE INPAL COPIISA is in charge of providing and installing 80% of the delivered pipes (17 km). Among the 20% remaining, after leaving the plant, the consortium also deals with earthwork with trenches that go to a 4 meter deep and a 9 meter width.

Barcelona, through this project and the Cofely network in the northern city, is a pioneer on the cooling/heating network market in the Spanish territory. This market, even though it has not been mature yet, is currently experiencing a whole structuration. **3E**



The company benefits from an efficient know-how thanks to a manufacturing process as performing as environmentally friendly. By offering products that optimize overall energy consumption, Inpal contributes to coming generation comfort. With a 30-year old energy expertise and over 10.000 km of installed networks, INPAL ENERGIE today ranks first on the French market and stays a major European actor on pre-insulated piping markets.

District heating and waste heat

- a combination preventing waste of energy

In Sweden, many district heating companies have been successful in utilizing industrial waste heat. The northern city of Luleå has one of Sweden's lowest heating costs for its inhabitants, largely thanks to the utilization of waste heat from the local ironworks/steel mill. As this example indicates, the future potential for energy saving is impressive indeed.

“Sweden is a country that has been successful in developing district heating during the last 40 to 50 years,” says Magnus Edin, Market Manager Heating, Comfort/HVAC, at Alfa Laval. “Luleå is a good example of successful cooperation between local industries and the district heating company. It demonstrates fantastic opportunities for other communities from a cost and financial as well as from an environmental point of view.”

In many companies and industries there are untapped opportunities for using waste heat or surplus heat. Such heat can be found in many forms, whether it is steam going out into the air or hot water going out into the ocean. By utilizing the waste heat when producing district heating, the same fuel does twice the work, thereby doubling fuel efficiency.

Alfa Laval plate heat exchangers and heat exchanger systems (i.e., substations) have become key components of district heating networks throughout the world. They take on the challenge of achieving an ideal temperature while holding down energy consumption in consideration of the environment.

Create effective district heating networks

When planning and analyzing total cost and total efficiency in any district heating network, there are several important factors to consider. Alfa Laval's Magnus Edin recommends focusing on the following:

1. Identify the need for heat (energy).

“In addition to acceptable insulation, every building needs a radiator- and a tap water system in balance (flow and pressure), and an efficient substation – i.e., a modern substation. In addition, it is important to make sure there are no leakages in the total district heating system.”

2. Identify available surplus heat and waste heat.

“This energy would otherwise be wasted, so it's a fantastic opportunity for any district heating system. Utilizing this opportunity is a win-win situation for any city or community.”

3. Take advantage of local fuel sources.

“Take advantage of locally available fuels and analyze the possibilities of using industrial and household waste as fuels for creating energy.”

4. Utilize combined heat and power plants.

“The rest of the required energy needs to be produced, and the most efficient way to do this is to utilize a combined heat and power plant with up to 90–95 percent efficiency. Again, use locally available fuels and make sure to consider environmental concerns.”

Great untapped potential

Magnus Edin says, “Although Sweden, Finland and Denmark are world leaders in utilizing waste heat for district heating, a lot of heat or energy is still wasted. We can do a lot more to utilize it.”

Worldwide, there is still more to be done. Huge heat losses appear in the EU energy balance, where a lot of heat is lost in power plants, oil refineries and industrial processes. Many of these losses could be retrieved and distributed by district heating systems to heat urban buildings. District heating systems provide the necessary heat load for high-efficiency combined heat and power plants and, at the same time, enable the use of renewable energy.

Impressive potential for energy reduction

In Russia, district heating is very common, and throughout Europe there are more than 5 000 district heating systems. Europe's district heating market share of the heat market is about 10 percent, and about 4 percent of heating in the United States is produced with district heating.

The overall potential for energy saving by using waste heat is staggering - especially so when implying future energy reduction by use of waste heat from industries in emerging economies. ☞

For further information, visit www.alfalaval.com/hvac



The new intelligent Energy Europe call for project proposals is open

– €67 million available for new Intelligent Energy – Europe projects



The new IEE call for project proposals is open! In 2012, there will be € 67 million available for funding. Do not miss the opportunity to submit your ideas for projects in areas such as energy efficiency, renewable energy sources, clean transport and local energy investments!

Focus on Energy efficiency and renewable energy in buildings

Background

Europe has adopted an ambitious vision for the energy performance of its buildings. By the end of 2020 (by the end of 2018 for public buildings) all new buildings shall be nearly “zero-energy buildings” (EPBD recast 2010/31/EU), with intermediate targets set by Member States by 2015. Member States shall draw up national action plans for increasing the number of “nearly zero-energy buildings”, including policies and measures to stimulate the refurbishment of the existing building stock into “nearly zero-energy buildings”. In addition, by 2015 all new buildings and buildings undergoing major renovation must have minimum levels of energy from renewable energy sources. A major transformation must occur in the building sector during the next few years, in which the role of the public sector is reinforced by even earlier deadlines. Actions launched in the period 2012–2013 should support and facilitate this transition.

The Energy Efficiency Plan 2011 focuses on instruments to trigger the renovation process in public and private buildings and to improve the energy performance of the

components and appliances used in them. It promotes the exemplary role of the public sector, proposing to accelerate the refurbishment rate of public buildings through a binding target (Following the adoption of the Energy Efficiency Plan 2011, the Commission proposed that as from 1 January 2014, 3% of the total floor area owned by public bodies is renovated each year to meet at least the minimum energy performance requirements set by the Member State concerned in application of Article 4 of Directive 2010/31/EU.)

Actions should support the acceleration of major renovations. With energy performance certification of buildings now being a reality in all EU Member States, it is feasible to capture the market not covered by major renovation. Step-wise renovation via uptake of the recommendations (including energy efficiency and renewable energies) indicated in the building’s energy performance certificate can reap major benefits. To this end, in the first stages of widespread implementation it is important to support the establishment of the certificate as a reliable market driver for renovation.

Regulation without enforcement leads to a lack of compliance. Poor quality workmanship and insufficient compliance checks in the building sector undermine efforts

to save energy saving and use renewable energies. Also, without knowledge of the levels of compliance it is difficult to determine the actual impact of current policies and regulations. Actions are needed to support compliance and for determining the impact of the existing regulations.

This approach supports the establishment of energy performance certification in the real estate market, linking it to quality of construction, whilst supporting the public sector which is called upon to act as a front runner.

Proposed project priorities 2012

Energy Performance Certification as a driver for step-by-step renovation: capturing the market

Actions bringing about increased uptake of the recommendations for energy efficiency and renewable energies of energy performance certificates. The actions should result in increased demand on the market for step-by-step renovation. This could include actions related to financing, resolving the owner/tenant dilemma, engaging consumers in relation to the significance of the recommendations made on buildings certification issued in line with the EPBD; bringing the industry together to develop one-stop shop solutions, etc.

Nearly Zero-Energy Buildings: transforming the existing building stock

Actions resulting in accelerated rates of refurbishment of existing buildings into Nearly Zero-Energy Buildings. This could include actions assisting the public sector on going beyond the proposed 3% renovation target, supporting the private sector, bringing together industry elements to provide packaged solutions, promoting frontrunners, etc.

Building as designed: quality and compliance in construction

Actions resulting in improved quality in construction and compliance to building codes in support of Article 10 of the recast EPBD (Directive 2010/31/EU) and Article 13(4) of the RES Directive (Directive 2009/28/EC). This could include market observatories, quality seals, etc, resulting in increased consumer confidence and demand for high quality construction in new buildings and renovations. In addition, establishment of robust benchmarks and knowledge of the actual performance of early renovations and installations will be a pre-requisite.



The call closes on **8 May 2012** for all types of actions except the Build Up Skills initiative which has different deadlines. For More information¹ please contact the “Intelligent Energy – Europe” helpdesk²

The IEE info day

The Intelligent Energy – Europe information day took place last Tuesday 24th January and gathered around 900 participants. The event was organized in networking sessions, bilateral meetings and workshops running in parallel. All presentation will be available on the IEE website, <http://ec.europa.eu/energy/intelligent/> 

¹ http://ec.europa.eu/energy/intelligent/getting-funds/call-for-proposals/how-to-apply/index_en.htm

² http://ec.europa.eu/energy/intelligent/contact/index_en.htm



EU regulations

– guidance to REHVA’s webpages

European legislation is a big challenge also to REHVA, who has a very important role to inform HVAC professionals about all new issues affecting our profession and industry. In this mission, REHVA has prepared webpages on EU regulations. These webpages were a result of the initiative from our supporters and after a short preparatory work opened in May 2011. The webpages give lots of links to further information – mainly to webpages of EU legislative bodies, to a number of EU Directives and Regulations, and also to European Standardization, R&D programmes and individual actions and projects which aim to support the development of EU legislation.



Jorma Railio
REHVA Fellow
Finland
jorma.railio@gmail.com

These pages can be found at <http://www.rehva.eu/en/eu-regulations> - the aim of this article is to provide a brief overview of the contents of the EU regulations webpages, and to introduce a few pages of the contents by a few examples of the text and brief notes about the items presented. A few other pieces

REHVA
3E

REHVA is the leading professional organization in Europe, dedicated to the improvement of health, comfort and energy efficiency in all buildings and communities. It encourages the development and application of both energy conservation and renewable energy sources.

Search...

Home
About REHVA
News
Events
Seminar presentations
Guidebooks
REHVA European HVAC Journal
e-Newsletter
HVAC Dictionary
HVAC Terminology
EU regulations

EU legislation >
EPBD >
Eco-design >
Energy Efficiency Directive >
Renewable energy sources directive (RES) >
Labelling of Products and Buildings >
Indoor and Outdoor Environmental Quality Standards and Standardization >
F-Gas >
Regulations related projects >
EU Regulations updates & news >

Main Page : EU regulations [print]

EU regulations

In this section you will find information related to the HVAC in buildings, that will help REHVA members and supporters to follow up all the EU regulations.

SEE UPDATES

EU legislation

Legislative process, Parliament, Council, Commission, Committees, Directives, Decisions, Regulations, Policy documents, Important directives.

EPBD - Energy performance of buildings directive

Directives, Concerted action EPBD, BUILD UP, Nearly Zero Energy Buildings, CEN Standards and EPBD, Cost efficiency.

Eco-design of energy related products directive (ErP)

Scope of the directive, HVAC product groups (Lots), Products regulations, Preparation studies, 2012-14 working programme.

NEW! Energy efficiency directive and repealing directives 2004/8/EC and 2006/32/EC

Scope of the proposal

RES
(Renewable energy sources directive)

of EU legislation, and of related activities, will be presented in later issues of REHVA Journal. Direct quotations from the pages are presented in separate boxes. The text here does not include the numerous hyperlinks, which lead the reader to a high number of other public webpages.

Contents – overview, the “EU legislation” page

The main page “EU Regulations” gives a link to the recent updates, and then presents briefly the contents of the 10 pages. ►

The Commission

The European Commission is responsible for drawing up proposals for new European legislation, which it presents to Parliament and the Council. The European Commission is organized into 20 departments (Directorate General - DG). Each department in the commission is lead by the Commissioner appointed by member states with help of permanent staff lead by Director-General.

The term ‘Commission’ is used in two senses. First, it refers to the team of men and women – one from each EU country – appointed to run the institution and take its decisions. Secondly, the term ‘Commission’ refers to the institution itself and to its staff. The day-to-day running of the Commission is done by its administrative officials, experts, translators, interpreters and secretarial staff. There are approximately 23 000 of these European civil servants. These EU officers prepare all legislation and balance the opinions of all interest groups (stakeholders).

The most common procedure for adopting (i.e. passing) EU legislation is “co-decision”. This procedure places the European Parliament (785 members) and the European Council (27 member countries) on an equal footing and it applies to legislation in a wide range of fields.

After this preparatory work in the committees, the proposals are handled in the Plenary meeting of the parliament. Simultaneously with the process in the parliament, the proposals are discussed by the Council of European Union.

What are EU directives?

EU directives lay down certain end results that must be achieved in every Member State. National authorities have to adapt their laws to meet these goals, but are free to decide how to do so. Directives may concern one or more Member States, or all of them. Each directive specifies the date by which the national laws must be adapted - giving national authorities the room for manoeuvre within the deadlines necessary to take account of differing national situations.

Directives are used to bring different national laws into line with each other, and are particularly common in matters affecting the operation of the single market (e.g. product safety standards).

What are EU regulations?

Regulations are the most direct form of EU law - as soon as they are passed, they have binding legal force throughout every Member State, on a par with national laws. National governments do not have to take action themselves to implement EU regulations. Regulations are passed either jointly by the EU Council and European Parliament, and by the Commission alone.

When a regulation comes into force, it overrides all national laws dealing with the same subject matter and subsequent national legislation must be consistent with and made in the light of the regulation.

What are EU decisions?

Decisions are EU laws relating to specific cases. They can come from the EU Council (sometimes jointly with the European Parliament) or the Commission. They can require authorities and individuals in Member States either do something or stop doing something, and can also confer rights on them. EU decisions are fully binding.

- The page “EU legislation” introduces the main elements in the legislation process and explains the main features of different types of regulations. The subtitles here are: **Legislative process, Parliament, Council, Commission, Committees, Directives, Decisions, Regulations, Policy documents, Important directives.**

The page describes the main legislative process and the role of the Commission, as well as a few words about the connections between the Commission, Parliament and Council.

Most important Directorates of the Commission related to building industry are listed with hyperlinks to the Directorates’ pages:

- Energy (DG ENER) –energy issues like Energy policy, Energy efficiency of buildings directive (EPBD), Eco-design of energy related products (ErP), district heating, renewable energies etc.
- Enterprise and industry(DG ENTR) – all general business related issues,
- Environment (DG ENV) – all environmental issues like building labelling
- Health and consumers (DG SANCO) – indoor air climate and health, radon etc.
- Research and innovation (DG RESEARCH) – funding of research projects and developing the research programmes
- Climate action (DG Clima) –F-gas regulations etc.
- ICT – Information society – Thematic network

A few paragraphs which give some additional information about the European parliament and the European Council can also be found from this page.

Directive, Regulation, Decision – what in common, what is different?

Perhaps the most discussed type of EU legislation is “Directive”. But also other types of legislative documents exist, and there are also significant differences in these, explained briefly on the pages.

The “EU legislation” page also explains a few most important activities and plans related to energy efficiency and policies to tackle the Global Climate Change, thus showing also big challenges to our industry and profession for the future. One of the main sources for further information in all energy issues on REHVA pages is the Commission’s website dealing with energy efficiency in buildings, see http://ec.europa.eu/energy/efficiency/buildings/buildings_en.htm.

The EPBD

The Directive on energy performance of buildings (2002/91/EC) is the main legislative instrument at EU level to achieve energy performance in buildings. Under this Directive, the Member States must apply minimum requirements as regards the energy performance of new and existing buildings, ensure the certification of their energy performance and require the regular inspection of boilers and air conditioning systems in buildings.

The EPBD page gives a short history, based on the descriptions at the Commission’s energy efficiency website, and describes the main contents with many links to the most important background documents. Milestones, and links to the most essential documents are listed.

- **Dec 2002:** EU adopts Energy Performance Buildings Directive (EPBD)
- **Jan 2006:** Deadline for transposing EPBD (2002) into national law.
- **Nov 2008:** Commission proposes revision of EPBD
- **Apr 2009:** Parliament adopts first-reading position
- **Nov 2009:** EU reaches political agreement on directive
- **May 2010:** Parliament approves new legislation.
- **May 2010:** EU adopts (approves) the recast (revised) EPBD 2010
- **End 2018:** Public buildings to have to be nearly zero energy standards.
- **End 2020:** All new buildings to be nearly zero energy.

The summary of the major changes in the recast 2010 compared to EPBD 2002 can be found from a linked slide presentation prepared by REHVA.

REHVA has specified the definitions to be use in the zero energy buildings. The page provides a direct link to the final report of the REHVA Task Force. This activity has been introduced in issues 3 and 5 of REHVA Journal 2011. [1],[2]

The EPBD page also introduces a few of the most important actions which aim to support and accelerate the implementation of the EPBD both into national legislation in Member States and into real practice:

- Concerted action, see www.epbd-ca.org
- The BuildUp portal, see www.buildup.eu
- European Standardization on EPBD – explained in more detail on the “Standards and standardization” page, which will be introduced in the next article.
- Cost efficiency: The recast EPBD requires the Commission to establish by 30 June 2011 a comparative framework methodology for calculating cost-optimal levels of minimum

REHVA is the leading professional organization in Europe, dedicated to the improvement of health, comfort and energy efficiency in all buildings and communities. It encourages the development and application of both energy conservation and renewable energy sources.

Home
About REHVA
News
Events
Seminar presentations
Guidebooks
REHVA European HVAC Journal
e-Newsletter
HVAC Dictionary
HVAC Terminology
EU regulations

EU legislation >
EPBD >
Eco-design >
Energy Efficiency Directive >

Main Page : [EU regulations](#) : EPBD [print]

EPBD

[Energy Performance Buildings Directive \(EPBD\)](#)
[Concerted action EPBD](#)
[BUILD UP](#)
[CEN Standards and EPBD](#)
[Cost efficiency](#)

Energy Performance Buildings Directive (EPBD)

Buildings account for 40 % of total energy consumption in the Union. Therefore, reduction of energy consumption and the use of energy from renewable sources in the buildings sector constitute important measures needed to

energy performance requirements for buildings and building elements. The draft of this methodology called “delegated Regulation supplementing Directive 2010/31/EU” is now published and can be downloaded from the page. A guideline - Commission staff working paper – also linked on the EPBD page provides relevant additional information to the Member States and reflects the accepted principles for the cost calculations required in the context of the Regulation. A separate subpage explains the Commission’s documentation in more detail.

Needs for development – also readers’ and users’ feedback is welcome

The pages were developed in spring 2011, and the recent updates have made a few additions. So it is obvious that it could not cover all subjects relevant to HVAC within this huge world of EU legislation. At least one major gap has been identified – the new Construction Products Regulation (CPR), which has replaced the old Construction Products Directive (CPD), is not yet introduced in this website yet. The CPR, briefly introduced in REHVA Journal 3/2011 [3], will most probably have more impact also on HVAC products than the old CPD - The CPR is expected to significantly improve the functioning of internal market for construction products. It will bring mandatory CE-marking to Finland, Sweden, UK, Ireland and Norway, where CE marking has been voluntary so far. In these countries

the impact of the CPR will be greater than in countries where CE-marking has already been mandatory.

Many HVAC products are also subject to other regulations not introduced in the pages yet. For example, CE marking is mandatory for air handling units by machinery and low voltage directives, proofing safety of AHUs, but not telling anything about air moving capacity. All products containing electrical or electronic components may be subject to EU legislation restricting the use of hazardous substances in electrical and electronic equipment (Directive 2002/95/EC; RoHS) and promoting the collection and recycling of such equipment (Directive 2002/96/EC; WEEE), although these regulations have so far left for national interpretations.

In any case, there is obviously a need for systematic and continuous improvement of the pages. All feedback from the users of these pages is welcome and important. REHVA welcomes comments on the existing texts, and suggestions to improve the pages.

References

- [1] Kurnitski, J. et al, How to define nearly net zero energy buildings nZEB – REHVA proposal for uniformed national implementation of EPBD recast. REHVA Journal 3/2011, p. 6-12
- [2] Kurnitski, J., How to calculate cost optimal nZEB energy performance? REHVA Journal 5/2011, p. 36-41.
- [3] Virtanen, M.J., The Construction Products Directive revised. REHVA Journal 3/2011, p. 89-91. **3E**

The Russian National Standard on "Green Building"

A number of laws were published in Russia over the last two years aimed at 40% reduction of the power consumption in buildings by 2020 and improvement of environmental safety. These laws introduce regulations for primary energy consumption, mandatory energy audits of buildings and use of alternative energy sources. Special attention of the Government and stakeholders is aimed at green construction.



Yury Tabunschikov

President ABOK
REHVA Fellow
ASHRAE Fellow



Alexander Naumov

Vice-president
ABOK
www.abok.ru

Green construction is one of the most promising directions for development not only in the construction complex, but also in the social environment.

In order to evaluate buildings according to the green construction system "ABOK" has designed standard "Green construction. Residential and public buildings. Rating system for environment sustainability evaluation." This Standard contains requirements for energy efficiency and environmental performance of buildings, as well as for a building in general as the human environment.

Evaluation of a building as human environment is related not only to the construction facility itself, but to other parameters, including the meaning of "human environment", namely: availability of parking zones, sport and children's facilities, parking spaces for cars and bicycles near the building, distance to public transport stops, etc.

Green buildings, as human environment, are attractive for investors, designers, utility equipment manufacturers and housing owners.

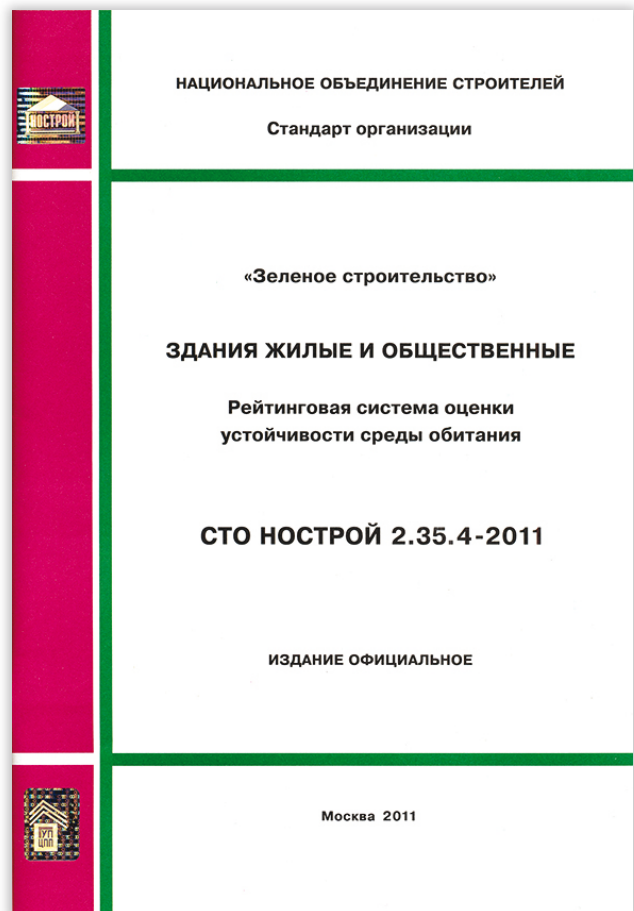

Requirements for green buildings are sufficiently high and cannot be met by the traditional design principles based mainly on typical solutions. As a result we need to arm designers, builders and operators with new creative knowledge.

In essence certification of a facility as a green building initiates a creative search for architects and engineers of such technical solutions that minimize negative and optimize positive influence of energy, environmental and

technological factors that define the building as human environment. In this work it is difficult to separate the creativity of architect and engineer: we have to consider their joint work during the entire design process and only such union can bring success in achievement of the set goal.

This standard is not the “final word” of the construction business development in Russia, but a road map that the construction industry must follow.

The construction society met this Standard positively. It is interesting for each link participating in the building life cycle – design, construction and operating organizations, investors, consumers, manufacturers of building materials, structures and engineering equipment.

A peculiarity of the Russian standard is that it contains 10 categories of the rating system of the environment sustainability. Categories and their weight are shown in **Table 1**.

Table 1. Categories of the human environment sustainability.

No.	Category name	Category weight, %
1	Comfort and quality of external environment	10.8
2	Quality of architecture and facility planning	9.2
3	Comfort and ecology of inner environment	13.3
4	Quality of sanitary protection and waste disposal	3.9
5	Rational water usage	6.1
6	Energy saving and energy efficiency	18.5
7	Use of alternative and renewable energy	9.2
8	Facility creation, operation and disposal ecology	9.8
9	Economic efficiency	10
10	Quality or project preparation and management	9.2
Each of these categories contains environment sustainability rating system criteria.		

Table 1 shows that the most important human environment rating criteria is “Energy saving and energy efficiency”. This category includes energy consumption evaluation criteria by building utility systems individually and the total consumption of primary energy. Let’s look at values of these criteria for multistory residential building:

The first criterion - Thermal energy consumption by heating and ventilation systems – evaluates decrease in the specific thermal energy consumption by the heating system. Its basic specific consumption is a calculated value that serves as the benchmark for comparison publically acceptable consumption level and acceptable level for use in the mass construction. Basic specific consumption values are given in appendix to the Standard.

For the residential building under consideration the basic specific thermal energy consumption by the heating and ventilation systems is 20 Wh/(m²°C day)

The second criterion – Thermal energy consumption for the hot water supply system – evaluates decrease in the basic specific thermal energy consumption rate by the hot water supply system.

The basic specific consumption with 21–25 m² apartment floor area per 1 person is 120 kWh/m².

The third criterion – Electricity consumption – is evaluated under the following criteria:

- decrease in the basic specific electricity consumption for building lighting;

For a residential building – determine the decrease in the basic specific electricity consumption for lighting of common areas. For example, the basic specific consumption for staircases, elevator lobbies and entrance lobbies is 30 kWh/m² per year.

- decrease in the basic specific electricity consumption for building utility systems;

The basic specific consumption for ten-storey residential building is 9.3 kWh/m² per year.

- decrease in the basic specific electricity consumption for air conditioning system.

For the design temperature of outside air in the warm period of 26°C and average daily specific inner heat emission of 11 W/m² the basic specific consumption is 15.5 Wh/(m²C per day).

A separate evaluation is done for installation of power consuming equipment and electrical devices labeled not lower than the two top categories of energy efficiency.

The fourth criterion – Total primary energy consumption for building energy supply systems – evaluated decrease in the basic specific consumption of primary energy for building utility systems.

For the building under consideration with 4 943 degree-days this basic specific consumption amounts to 49.4 kg of conventional fuel/m² per year.

Such approach allows for the most precise and diverse evaluation of green buildings, and its main advantage is possibility to optimize the energy transformation processes and minimize the consumption of primary energy resources for production of a unit of final energy carrier.

”Comfort and ecology of inner environment” is the second important one in the rating system and includes ”Control and management of building utility systems” criterion. This criterion evaluates availability of a centralized building control system with possibility of individual (zoned) regulation and local utility automation systems, which also helps to reduce power consumption through, for example selection of efficient thermal energy regulation algorithm for heating, taking into consideration room usage density, usage mode, preferences of users, etc. This category also includes the requirements for light, acoustic, air temperature comfort and protection of rooms from radon accumulation.

The third important is ”Comfort and quality of outer environment” category that evaluates the parameters and conditions of the external environment, e.g. accessibility of public transportation and social infrastructure objects, greenery of the adjacent territory, proximity of water bodies, visual comfort, etc.

One should also note that the Standard lists economic requirements for the facility in ”Economic efficiency” category. For example, ”Value of reduced costs for the facility life cycle” criterion evaluates the share of specific reduced (discounted) total costs for the facility from the corresponding share for similar object, and ”Value of annual operational costs” criterion evaluates the relation of mean annual operational costs (energy, water, maintenance, repairs) to the similar costs for a traditional equivalent facility.

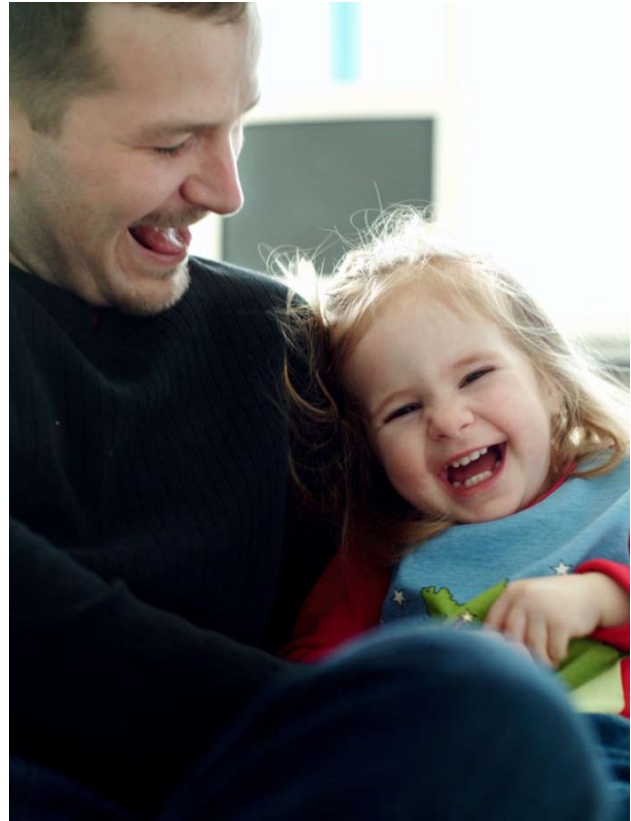

”Ecology of creation, operation and disposal of facility” category set the following evaluation criteria: minimization of the effect from materials used in construction on the environment; minimization of waste from performance of construction works; measures aimed at protection and restoration of the environment during construction, as well as minimization of impact during operation and disposal of the building.

”Quality of facility architecture and planning” category contains ”Supply of building with natural lighting” criterion, which evaluates the percentage of excess of regulatory coefficient of natural lighting inside building. This in turn provides for reduction of electricity consumption for lighting, as well as improvement of the human environment quality.

The same category contains ”Optimal form and orientation of building” criterion allowing for evaluation of the thermal energy impact of the outside climate on the building envelope using the building’s thermal performance factor. This coefficient is calculated as ratio of the minimum specific thermal energy consumption for building heating to the design consumption used during design. Such design approach allows for optimization of the positive and minimization of the negative impact of the external climate on



the building envelope, thus leading to a decrease in the consumption of fuel and energy resources during the heating period.

This category also evaluates the quality of architectural appearance of the building, greenery around the building, sufficiency of useful area, comfort of space design solutions, and sufficiency of parking spaces.

Moreover, the Standard set aside "Usage of alternative and renewable energy" category that evaluates the share of secondary and renewable energy in the facility's annual energy balance, thus helping to achieve high energy efficiency indicators and meeting the requirements for sustainable human environment.

Another important category is "Quality of project development and management". This category evaluates the designer's experience in design of green buildings, developer's (general contractor's) experience in construction of green buildings, and managing company's experience in operation of green buildings. Moreover this category contains "Performance of scientific research in preparation of the project" allowing for evaluation of simulation activities for optimization of energy efficiency in buildings and performance of alternatives' analysis of the human environment sustainability.

"Rational water use" category set the requirements for reduction of specific water consumption per person per year in relation to the regulatory value, and level of discharge treatment ("grey" discharge and storm waters).

Sanitary measures and waste treatment measures are evaluated in "Quality of sanitary protection and waste treatment" category: automated systems of antibacterial treatment, organization of primary waste sorting and system for disposal of mercury waste.

Overall the rating system requirements are aimed at reduction of the energy resources consumption, use of untraditional, renewable and secondary energy resources, rational water consumption, reduction of hazardous impact on the environment during the building construction and operation, including adjacent territory, for creation of comfortable human environment and sufficient economic feasibility of architectural, construction and engineering solutions.

Depending on the number of points received from rating criteria a building receives human environment sustainability category and receives a certificate of compliance.

The first international contest for "Green construction. Architecture and technology" was announced for practical wide-scale approbation of this standard. **3E**

FINVAC – The Finnish Association of HVAC Societies

Summary of activities and collaboration

FINVAC is a joint organization in Finland, in which four national societies of HVAC organizations (SuLVI, VSF, LIVI, SIY) participate. The societies are professional and technical societies devoted to promoting the arts and sciences of heating, ventilating, air-conditioning and allied technologies and to inform and arrange training activities in this field. FINVAC cooperates with several organizations, with SCANVAC in the Nordic countries, with REHVA in Europe and with ASHRAE in USA.

FINVAC

The Finnish Association of HVAC Societies



Siru Lönnqvist

REHVA Fellow

Head of Secretariat, FINVAC, Finland

siru.lonnqvist@finvac.org

FINVAC members

Suomen LVI-Liitto, SuLVI ry

SuLVI is established 1930. It is the national “umbrella” of 33 local HVAC societies in Finland. The number of personal members in these local societies is about 5 000. SuLVI, together with HVAC branch associations (industry, contracting...) publishes a Finnish language HVAC Journal “Talotekniikka” with 8 issues/year.

VVS Föreningen i Finland rf (VSF)

VSF is established 1936. It is the society for the Swedish speaking Finns in the HVAC-branch, with some 650 personal members. VSF publishes their own HVAC Journal “VVS värme- och sanitetsteknikern”, with 5 issues/year in Swedish.

Lämpöinsinööriyhdistys LIVI

LIVI is established 1959. It is a corporate member of “RIL” and a society for engineers M.Sc.(Tech) working in the area of HVAC engineering. The parent organization RIL, founded in 1934, is an organization for civil engineers with Master of Science degree and university students of civil engineering. RIL supports the development of building, urban planning and environmental technology and acts to preserve solid and durable building and maintenance traditions. The number of personal members in LIVI is about 240.

Sisäilmäyhdistys ry (SIY)

SIY is established 1990 and is also known as FiSIAQ according to the English language name. FiSIAQ is a non-profit organization whose purpose is to disseminate research results into practice in the construction and real estate sector. FiSIAQ carries out in Finland many activities similar to those of ISIAQ. FiSIAQ has a contact network of over 9 000 individuals interested

in IAQ issues. Over 150 companies, Finnish and international, support their work. FiSIAQ’s main products are the “Sisäilmauutiset” newsletter with 4 issues/year in Finnish language, the annual Indoor climate seminar and the Classification of Indoor Climate. During its existence, FiSIAQ has published several reports and guidelines, the proceedings of two international conferences and one textbook. Internationally, FiSIAQ is known as an organizer of international conferences: Indoor Air ’93, Healthy Buildings 2000, and, together with a few other Finnish organizations, Clima 2007 WellBeing Indoors and Roomvent 2007 conferences.

FISE – Qualification of Professionals in Building, HVAC and Real Estate Sector in Finland

FISE recognizes qualifications in building planning as well in site supervision and management based on law and complementary building act and code. Moreover, it has been included in the system a voluntary recognition of market-driven construction and built property professionals’ qualifications.

FISE covers approximately 40 professions and has recognized over 7 400 competencies. There are 18 stakeholder organizations in FISE, including SuLVI, VSF and RIL. SuLVI is in charge of the secretariat in HVAC qualifications, including for example ventilation designers, foreman of water supply and sewage installations of buildings and issuers of energy performance certificates. Qualification is recognized for seven years at a time. Recognition may be withdrawn with reason, before the validity expires.

FISE recognizes qualifications based on 25 qualification committees, named by FISE’s board of directors, and handled by 8 secretaries. Meetings are held at least twice

a year. Two hundred experts are doing mostly voluntary work in the committees in eight secretary organizations.

Promoting the use of REHVA publications

FINVAC has arranged translations of two **REHVA Guidebooks** into Finnish, namely GB 1 (Displacement ventilation), GB 7 (Low temperature heating and high temperature cooling). GB 12 (Solar shading) is also available in Finnish, translated jointly by SuLVI and Aurinkosuoja ry (the Finnish member of ES-SO). Negotiations and campaigns are ongoing in order to increase the use of GBs (and supporting material such as PowerPoint presentations prepared by REHVA) for educational purposes at universities.

REHVA Dictionary terms have been translated into Finnish with support of FINVAC in several phases. The most recent action, carried out by a product group among LIVI members in 2011, increased the number of Finnish language terms by 2 000 new ones into more than 11 600, leaving just some 700 words without translation. In addition,

of some 250 additional terms were suggested, most of these deal with energy performance of buildings.

Collaboration

A few examples of collaboration between FINVAC, its member organizations and other organizations have been presented earlier in the text. Here just a couple of others, showing the variety of joint activities from permanent forums to half-day joint seminars:

- FINVAC member organizations are active in a collaboration forum focusing on issues related to energy performance of buildings. In the Finnish HVAC energy forum the manufacturers, designers and contractors prepare common position papers and arrange contacts with MEPs and national decision-makers.
- FINVAC arranged in 2011, together with RIL, a seminar targeted to Finnish HVAC professionals and civil engineers, about technical EU legislation and REHVA's main activities. **3E**



HITEMA
PRECISION COOLING

Cooling equipment with superior operational qualities and high performance levels!

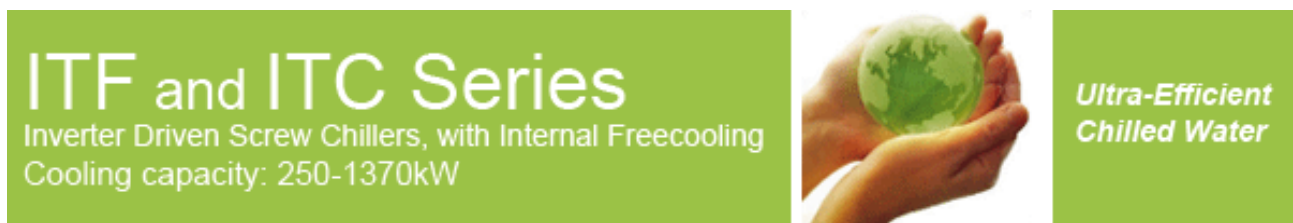

ITF and ITC Series
Inverter Driven Screw Chillers, with Internal Freecooling
Cooling capacity: 250-1370kW

Ultra-Efficient Chilled Water



Hitema, International Partner.

Advanced technology, absolute quality and closing at the Customer strong points that **Hitema** uses for its growth. **Hitema** is a Company that has shown competitive capacity and a big flexibility at Market requirements and it has been able to play a leading role thanks to the ability to place good technological solution for industrial refrigeration, close control units and HVAC design for data center and switch rooms and compressed air treatment. Surely, determined factors of our growth are the importance of the full satisfaction of the **Customer** and the various of the offer, with new products marked by **innovation and quality**.

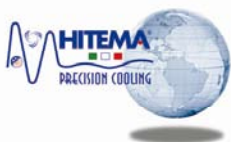

Z.I. San Gabriele - 35024 Bovolenta (Padova) - Italy
Tel.: +39 049 5386344 r.a. 12 lines - Fax: +39 049 5386300
E-mail: sales@hitema.it - Web page: www.hitema.it

The Global Solution To All Your Cooling Needs

EVENTS 2012

23–25 February	XIII Conference and Exhibition “Software for heating, ventilation, air conditioning, water and heat supply. Projection, calculations, equipment selection, automation systems,”	Moscow, Russia	www.abok.ru
13 March	Round table “Normative and methodological support in the design and construction. ABOK Standards System TM” in the framework of the “Climate World”	Moscow, Russia	www.abok.ru
13–14 March	II Energy Services Congress - Efficient Energy Management: a need for savings	Barcelona, Spain	www.congresoeses.com
22–23 March	Norwegian Cooling Technology Conference	Bodo, Norway	www.nkm2012.no
29 March	4 th International Symposium Solar and Renewable Cooling	Stuttgart, Germany	www.cep-expo.de
30 March	6 th International Conference on Application of Biomass Gasification	Stuttgart, Germany	www.cep-expo.de
29–31 March	CEP® Clean Energy & Passivehouse 2012	Stuttgart, Germany	www.cep-expo.de
28 March	REHVA and AICARR seminar at MCE, HVAC in Zero Energy Buildings	Fiera Milano, Italy	www.rehva.eu
9–15 April	Simurex 2012	Cargese, France	http://simurex.ibpsa.fr
16 April	REHVA Seminar in Light and Building	Frankfurt, Germany	www.rehva.eu
17–20 April	REHVA Annual Conference and Meeting	Timisoara, Romania	www.rehva-am2012.ro
17–19 April	XVI European AVOK-EHI Symposium “Modern energy-efficient equipment for heating, water and air-conditioning of buildings”	Moscow, Russia	www.abok.ru
18–21 April	International construction forum Interstroyexpo 2012	St. Petersburg, Russia	www.abok.ru
26–27 April	Focus on Renewable District Heating and Cooling	Copenhagen, Denmark	www.euroheat.org
30 April – 2 May	X. International HVAC+R Technology Symposium	Istanbul, Turkey	www.ttmd.org.tr/2012sempozyum
24–25 May	Romanian International Conference on Energy Performance of Buildings. “European Solutions and Policies for Sustainable Urban Development: Theory and Practice”	Bucarest, Romania	www.aiiro.ro
24–25 May	Conference on “Creating a climate for the desired objects of cultural heritage: monuments, museums, buildings for religious purposes”	Moscow, Russia	www.abok.ru
6–8 June	Conférence IBPSA France 2012	Chambery, France	http://www.ibpsa.fr
18–22 June	EU Sustainable Energy Week 2012 in Brussels	Brussels, Belgium	www.eusew.eu
25–27 June	10 th IIF/IIR Gustav Lorentzen Conference on Natural Refrigerants	Delft, The Netherlands	www.gl2012.nl
25 June – 8 July	Holiday Housing Fair	Lappeenranta, Finland	www.asuntomessut.fi
8–12 July	Healthy Buildings	Brisbane, Australia	www.hb2012.org
12 July – 12 Aug.	Housing Fair 2012	Tampere, Finland	www.asuntomessut.fi/en/housing-fair-2012-tampere
3–7 September	ICCCS 2012 – International Symposium on Contamination Control 2012	Zurich, Switzerland	www.icccs2012.ethz.ch
14 September	33 rd AICVF Congress	Brodeaux, France	http://aicvf.org/blog/agenda/congres-2012
17–19 September	Ventilation 2012	Paris, France	www.inrs-ventilation2012.fr
10–11 October	33 rd AIVC Conference and 2 nd TightVent Conference	Brussels, Belgium	www.aivc.org
17–19 October	47 th Conference of Plants – “Plants for the Early Third Millennium”	Sinaia, Romania	www.aiiro.ro
12–14 November	7 th International HVAC Cold Climate Conference	Calgary, Alberta, Canada	http://ashraem.confex.com/ashraem/icc12/cfp.cgi
5–7 December	43 th International congress of Heating, Air Conditioning and Refrigeration	Belgrade, Serbia	www.kgh-kongres.org/

FAIRS 2012

23–25 February	ACREX 2012	Bangalore, India	www.acrex.org.in
29 Feb. – 3 Mar.	SINERCLIMA 2012	Batalha, Portugal	www.eventseye.com
20–22 March	Ecobuild 2012	London, United Kingdom	www.ecobuild.co.uk
20–23 March	NORDBYGG 2012	Stockholm, Sweden	www.nordbygg.se
27–30 March	MCE - Mostra Convegno Expocomfort 2012	Fiera Milano, Italy	www.mcxpocomfort.it
15–20 April	Light + Building	Frankfurt, Germany	www.light-building.messefrankfurt.com
17–19 April	International Trade Fair & Conference “SHK – ISH Moscow 2012”	Moscow, Russia	www.abok.ru
2–5 May	ISK - SODEX 2012	Istanbul, Turkey	www.hmsf.com
10–12 May	RENEXPO® Central Europe, 6. International Energy Trade Fair	Budapest, Hungary	www.renxpo.hu
9–11 October	Chillventa 2012	Nuremberg, Germany	www.chillventa.de/en/
9–11 October	Finnbuild 2012	Helsinki, Finland	www.finnbuild.fi
17–18 October	CEP® Clean Energy & Passive House Expo	Budapest, Hungary	www.cep-expo.hu

Your Solution Partner for HVAC & R Products



Blast Freezers

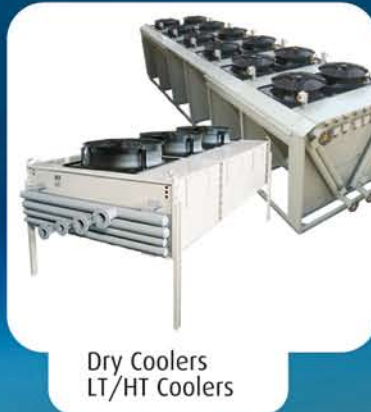

Dry Coolers
 LT/HT Coolers



Air Cooled Condensers



Starbox
 Codensing Units



OEM Finned
 Pack Heat Exchangers
 and Steam Coils



Wet / Dry Coolers with
 Ecomesh Spray System



Air Coolers



Air Heating and
 Cooling Coils Using Water,
 Software COILS 5.5 FRT1



ID NO: COILS-02-04-001/002/003/004

F2522-3/8"
 F3833-5/8"
 F4035-1/2"
 F4035-5/8"



Head office / Factory

Organize Deri Sanayi Bölgesi 18. Yol 34957 Tuzla İstanbul/Turkey

Tel: +90 216 394 12 82 (pbx) Fax: +90 216 394 12 87

e-mail: info@friterm.com web: http://www.friterm.com



REHVA SUPPORTERS

A REHVA supporter is a company or an organisation that shares the same objectives as REHVA. Our REHVA supporters use the latest European technologies to make their products. The REHVA Supporters are also members of reHVAClub. For more information about REHVA supporters' program, please contact info@rehva.eu or call +32 2 5141171.



Baltimore Aircoil



38^ Mostra Convegno Expocomfort 27-30 March 2012 fieramilano



human
comfort
solutions

Heating, cooling, water, energy.
Four sectors, one single great event.

From March 27 to 30, 2012
the world leading exhibition
in the HVAC, plumbing and sanitary
fitting sectors will bring to Milan
a complete showcase of the most
advanced technologies for comfort,
efficiency and energy saving.

Air conditioning, Ventilation /
Refrigeration / Heat pumps /
Insulation / Heating /
Renewable Energy /
Implements and tools /
HVAC components /
Plumbing technology / Water treatment /
Home and building automation /
Taps / Coatings / Bathroom ceramics /
Radiators / Bathroom accessories

www.mcexpocomfort.it



supported by



organised by



in cooperation with



REHVA Guidebooks are written by teams of European experts

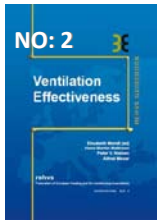

Improving the ventilation effectiveness allows the indoor air quality to be significantly enhanced without the need for higher air changes in the building, thereby avoiding the higher costs and energy consumption associated with increasing the ventilation rates. This Guidebook provides easy-to-understand descriptions of the indices used to measure the performance of a ventilation system and which indices to use in different cases.

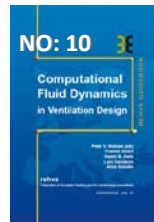

CFD-calculations have been rapidly developed to a powerful tool for the analysis of air pollution distribution in various spaces. However, the user of CFD-calculation should be aware of the basic principles of calculations and specifically the boundary conditions. Computational Fluid Dynamics (CFD) – in Ventilation Design models is written by a working group of highly qualified international experts representing research, consulting and design.

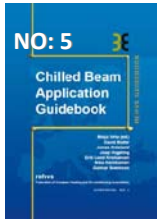

Chilled beam systems are primarily used for cooling and ventilation in spaces, which appreciate good indoor environmental quality and individual space control. Active chilled beams are connected to the ventilation ductwork, high temperature cold water, and when desired, low temperature hot water system. Primary air supply induces room air to be recirculated through the heat exchanger of the chilled beam. In order to cool or heat the room either cold or warm water is cycled through the heat exchanger.

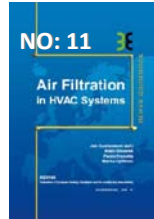

Air filtration Guidebook will help the designer and user to understand the background and criteria for air filtration, how to select air filters and avoid problems associated with hygienic and other conditions at operation of air filters. The selection of air filters is based on external conditions such as levels of existing pollutants, indoor air quality and energy efficiency requirements.

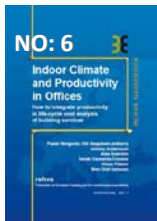

Indoor Climate and Productivity in Offices Guidebook shows how to quantify the effects of indoor environment on office work and also how to include these effects in the calculation of building costs. Such calculations have not been performed previously, because very little data has been available. The quantitative relationships presented in this Guidebook can be used to calculate the costs and benefits of running and operating the building.

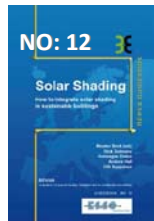

Solar Shading Guidebook gives a solid background on the physics of solar radiation and its behaviour in window with solar shading systems. Major focus of the Guidebook is on the effect of solar shading in the use of energy for cooling, heating and lighting. The book gives also practical guidance for selection, installation and operation of solar shading as well as future trends in integration of HVAC-systems with solar control.



This Guidebook describes the systems that use water as heat-carrier and when the heat exchange within the conditioned space is more than 50% radiant. Embedded systems insulated from the main building structure (floor, wall and ceiling) are used in all types of buildings and work with heat carriers at low temperatures for heating and relatively high temperature for cooling.

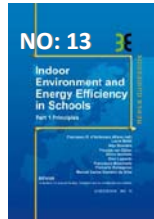

School buildings represent a significant part of the building stock and also a noteworthy part of the total energy use. Indoor and Energy Efficiency in Schools Guidebook describes the optimal design and operation of schools with respect to low energy cost and performance of the students. It focuses particularly on energy efficient systems for a healthy indoor environment.

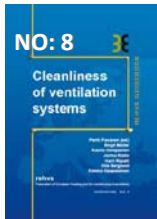

Cleanliness of ventilation systems Guidebook aims to show that indoor environmental conditions substantially influence health and productivity. This Guidebook presents criteria and methods on how to design, install and maintain clean air handling systems for better indoor air quality.

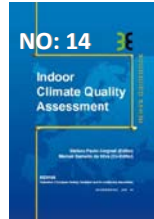

This new REHVA Guidebook gives building professionals a useful support in the practical measurements and monitoring of the indoor climate in buildings. Wireless technologies for measurement and monitoring has allowed enlarging significantly number of possible applications, especially in existing buildings. The Guidebook illustrates with several cases the instrumentation for the monitoring and assessment of indoor climate.

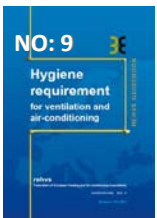

Hygiene requirement is intended to provide a holistic formulation of hygiene-related constructional, technical and organisational requirements to be observed in the planning, manufacture, execution, operation and maintenance of ventilating and air-conditioning systems. These requirements for ventilating and air-conditioning systems primarily serve to protect human health.

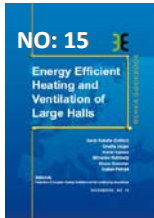

This guidebook is focused on modern methods for design, control and operation of energy efficient heating systems in large spaces and industrial halls. The book deals with thermal comfort, light and dark gas radiant heaters, panel radiant heating, floor heating and industrial air heating systems. Various heating systems are illustrated with case studies. Design principles, methods and modeling tools are presented for various systems.



This guidebook talks about the interaction of sustainability and Heating, ventilation and air-conditioning. HVAC technologies used in sustainable buildings are described. This book also provides a list of questions to be asked in various phases of building's life time. Different case studies of sustainable office buildings are presented.

**New REHVA
 eGuidebooks available
 at www.beuth.de!**

**Coming
 soon!**