

**EPBD in transition**

**CLIMA 2022 Papers  
on Energy**

**Eurovent Certification  
overview**





# REHVA

## 3 BRUSSELS SUMMIT

14-15 November 2022

*join us!*



**Editor-in-Chief:**

Jaap Hogeling  
jh@rehva.eu

**Editorial Assistant:**

Marie Joannes  
mj@rehva.eu

**General Executive:**

Ismail Ceyhan, Turkey

**REHVA BOARD**

**President:**

Cătălin Lungu

**Vice Presidents:**

Lada Hensen Centnerová

Livio Mazzarella

Pedro Vicente-Quiles

Johann Zirngibl

Ivo Martinac

Kemal Gani Bayraktar

**EDITORIAL BOARD**

Murat Cakan, Turkey

Guangyu Cao, Norway

Tiberiu Catalina, Romania

Francesca R. d'Ambrosio, Italy

Ioan Silviu Dobosi, Romania

Lada Hensen, The Netherlands

Karel Kabele, Czech Republic

Risto Kosonen, Finland

Jarek Kurnitski, Estonia

Livio Mazzarella, Italy

Dejan Mumovic, United Kingdom

Ilinca Nastase, Romania

Natasa Nord, Norway

Dusan Petras, Slovakia

Olli Seppänen, Finland

Branislav Todorovic, Serbia

Peter Wouters, Belgium

**CREATIVE DESIGN AND LAYOUT**

Jarkko Narvanne, jarkko.narvanne@gmail.com

**ADVERTISEMENTS**

Nicoll Marucciová, nm@rehva.eu

**SUBSCRIPTIONS AND**

**CHANGES OF ADDRESSES**

**REHVA OFFICE:**

Washington Street 40

1050 Brussels, Belgium

Tel: +32-2-5141171

info@rehva.eu, www.rehva.eu

**PUBLISHER**

TEKNİK SEKTÖR YAYINCILIĞI A.Ş.

Fikirtepe Mah., Rüzgar Sk. No: 44C

A3 Blok, Kat:11 D:124 Kadıköy/Istanbul, Turkey

REHVA Journal is distributed in over 50 countries through the Member Associations and other institutions. The views expressed in the Journal are not necessarily those of REHVA or its members. REHVA will not be under any liability whatsoever in respect of contributed articles.

Cover photo: Jiri Hera / shutterstock.com

*Contents*

Download the articles from [www.rehva.eu](http://www.rehva.eu) -> REHVA Journal

**EDITORIAL**

- 4 EPBD revision ongoing**  
Jaap Hogeling

**ARTICLES**

- 5 How to set primary energy requirements so that poor building envelope cannot be compensated with extensive PV?**  
Jarek Kurnitski & Jaap Hogeling

- 9 Insert: Opinion on deep energy renovation by REHVA Member**  
Tomasz Cholewa

- 10 The EPBD recast: how to come to a transparent and fair ZEB definition**  
Dick van Dijk & Jarek Kurnitski

- 16 CLIMA 2022 conference papers on the theme ENERGY**

- 18 Going active: How do people envision the next generation of buildings?**  
Elli Nikolaidou, Ian Walker, David Coley, Stephen Allen & Daniel Fosas

- 27 5-year performance of a Swedish mixed-use ground source heat pump system**  
Jeffrey D. Spitler & Signhild E. A. Gehlin

- 37 Design of highly compact indirect evaporative coolers**  
Francisco Comino, Jesús Castillo-González, Francisco J. Navas-Martos, Pablo E. Romero & Manuel Ruiz de Adana

- 43 A common European EPB Assessment and Certification scheme. U-CERT's proposal**  
Pablo Carnero, Dick van Dijk, Niccolò Mignani & Gabriela Ana

- 51 Review of Certification Procedure for Inverter Air Conditioner**  
Ali Nour Eddine

- 57 Deep energy renovation, the effect of airtightness and heat recovery in renovation projects**  
Mikko Iivonen

**CASE STUDIES**

- 61 Start breathing – future of non-residential buildings has started!**  
Ralf Wagner

**PRODUCT CERTIFICATION**

- 67 Certification Programmes for domestic, commercial and industrial facilities**

**EU POLICY NEWS**

- 87 Why embrace the EU framework for sustainable buildings (and where to start)?**  
Josefina Lindblom

**PRODUCT NEWS**

- 90 Indoor air quality – why it is important and what it hinges upon.**

**PUBLICATIONS**

- 96 CIBSE TM54: 2022 – A UK perspective on evaluating operational energy use at the design stage**  
Dejan Mumovic, Nishesh Jian & Esfand Burman

**EVENTS & FAIRS**

- 100 Exhibitions, Conferences and Seminars in 2022**

- 103 Innovative impulses for building technology at Light + Building and ISH**

*Advertisers*

✓ REHVA BRUSSELS SUMMIT .....	2	✓ LIGHT + BUILDING .....	102
✓ PURMO GROUP .....	56	✓ REHVA MEMBERS .....	105
✓ BELIMO .....	95	✓ REHVA SUPPORTERS .....	106
✓ REHVA SEMINAR AT EUSEW .....	99	✓ ECC .....	107
✓ REFCOLD INDIA .....	101	✓ NEW REHVA GUIDEBOOK #32 .....	108

*Next issue of REHVA Journal*

Instructions for authors are available at [www.rehva.eu](http://www.rehva.eu) (> Publications & Resources > Journal Information). Send the manuscripts of articles for the journal to Jaap Hogeling [jh@rehva.eu](mailto:jh@rehva.eu).

# EPBD revision ongoing

The currently ongoing revision of the Energy Performance of Buildings Directive (EPBD) is part of the 2021 Commission Work Programme “Fit for 55” package and complements the other components of the package proposed in July 2021, setting the vision for achieving a zero-emission building stock by 2050. As already indicated in the Climate Action Plan, it is a key legislative instrument to deliver on the 2030 and 2050 decarbonisation objectives. It follows up on key components of the three focus areas of the Renovation Wave Strategy, including the intention to propose mandatory minimum energy performance standards, following an impact assessment looking at their scope, timeline, phasing in and accompanying support policies. Given the need for appropriate consultation and impact assessment processes, the proposed EPBD revision could only come slightly later than the first set of “Fit for 55” initiatives adopted in July 2021.

This issue includes 2 articles on the discussion regarding the ongoing EPBD revision. The authors analysed the 2021-12 EPBD draft and have been heavily involved in discussions around the EPBD revision and related set of EPB standards. The EPBD key goal (recital 19) is: “The enhanced climate and energy ambition of the Union requires a new vision for buildings: the zero-emission building, the very low energy demand of which is fully covered by energy from renewable sources where technically feasible.”. How to prove that we reach this goal? This requires transparent and consistent definitions and assessment procedures.

By publishing these expert views and explanations REHVA expects to contribute to a final EPBD text that will serve its purpose.

In the 2 articles “How to set primary energy requirements so that poor building envelope cannot be compensated with extensive PV?” and “The EPBD recast: how to come to a transparent and fair ZEB definition” the importance of a consistent and transparent ZEB definition and assessment procedures is explained. The 2nd article proposes a new and simple metric that can be used for threshold values for “the very low energy demand” that for a zero emission building (ZEB) is to be “fully covered by energy from renewable sources”



## CLIMA 2022

This issue also addresses the CLIMA 2022 conference papers on the theme “ENERGY”. 10 papers are highlighted and 4 have been selected to include in this RJ issue. All CLIMA 2022 papers are freely available at <https://proceedings.open.tudelft.nl/clima2022>

## Eurovent Certita certification

REHVA is proud to publish this yearly overview of this European certification program. This includes 48 certification programs covering 66% of the HVAC products sold in Europe. See also <https://www.eurovent-certification.com/en/> ■



**JAAP HOGELING**

Editor-in-Chief  
REHVA Journal



# How to set primary energy requirements so that poor building envelope cannot be compensated with extensive PV?



**JAREK KURNITSKI**  
REHVA Technology and  
Research Committee,  
Tallinn University of  
Technology



**JAAP HOGELING**  
EPB Center,  
Chairperson of  
CEN/TC371

Ongoing EPBD revision has brought up a question how the definition of zero-emission buildings (ZEB) should be established so that it will support the application of energy efficiency measures hand in hand with renewable energy measures and would avoid possible misuses based on compensation due to renewable energy production on-site when included in the annual balance calculation. More specifically the issue is related to on-site photovoltaic (PV) generation. In the winter there is no or very limited PV generation and buildings have to use grid electricity that will cause CO<sub>2</sub> emissions. These grid CO<sub>2</sub> emissions happen in the different time, the heating season, where sufficient PV generation is not available. Even in cases with very extensive PV installations and export in the summer buildings cannot benefit from this without seasonal electricity storage. On a shorter time scale, hourly variations during the day, similar effects occur.

Therefore, it is important to minimize the use of fossil energy at timesteps having a shortage of renewable energy, for which assessment an hourly energy use and generation calculation is needed. ZEB entirely or largely based on renewables, i.e. fossil energy use compensation by surplus of renewable energy in summer and during peak (sunny) hours will not be the case when hourly balances will be applied. When monthly or annual balances are applied (part of) the fossil energy use remains unknown: it is disguised by

the averaging over a longer period; in other words, it is unintentionally and implicitly compensated.

In the following we look which energy performance indicator can avoid this compensation problem.

To illustrate the problem and to test relevant energy performance indicators a calculation example of a single-family house shown in **Figure 1** was prepared with two cases:

- Highly insulated building envelope and relatively small amount of PV
- Less insulated building envelope with an attempt to compensate with extensive PV



**Figure 1.** 176.5 m<sup>2</sup> single-family house used in energy calculations.

The highly insulated building had 5 kW PV system, U-values of external walls, roof, slab on the ground and windows were 0.13, 0.09, 0.1 and 0.82 W/m<sup>2</sup> K respectively, and a mechanical ventilation system with a heat recovery efficiency of 80%.

The less insulated building had corresponding U-values of 0.30, 0.22, 0.26 and 1.4, heat recovery efficiency of 60% and the PV system of 10.8 kW was selected so that with air to water heat pump the non-renewable primary energy with compensation for the surplus of electricity exported to the grid was the same as in the highly insulated case.

The values for the energy need and energy use were calculated on hourly basis following the assessment procedures in the set of EPB standards. Both cases were calculated with three energy sources:

- air to water heat pump (AWHP);
- gas boiler;
- district heating (DH).

The building was located in the Nordic climate zone and the highly insulated variant fulfilled present Estonian NZEB requirement with DH and AWHP, but not with gas boiler. Non-renewable (non-ren PE) and total primary energy (total PE) were calculated with PV electricity that is self-used and used in other on-site uses (lighting and appliances) and alternatively with export compensation to see which indicator would allow to set a threshold assuring efficiency and renewables go hand in hand and not allowing to compensate efficiency with extensive PV.

As EPBD recast proposal (dd 2021-12-13) defines ZEB as **a building with a very high energy performance, where the very low amount of energy still required is fully covered by energy from renewable sources**, the total amount of renewable energy (RE) including the export was also calculated. The primary energy factors (PEF) applied in the calculation are from informative Annex B of EN ISO 52000-1, with only exception for the efficient district heating which has a higher efficiency not defined in the standard and followed EED definition, see **Table 1**.

**Table 2** reports energy calculation for the highly insulated building. It can be seen that non-ren PE shows the best result with efficient district heating (DH), followed by AWHP, while the gas boiler is clearly the worst one. Total PE provides a completely opposite result: efficient district heating is the worse one – so the gas would be better than district heating if the threshold of total PE would be used. This demonstrates that the **total PE is not a relevant indicator to assess energy performance of buildings**.

How the primary energy values are calculated can be seen from **Figure 2**, illustrating non-ren PE calculation for AWHP case. For DH and gas, the calculation is similar, but in addition to electricity use (blue values in **Table 2**) district heating/gas (yellow values in **Table 2**) are to be added with corresponding non-ren PEF values in **Table 1**. In the total PE calculation, total PEF values are used and RE (either the self-use, or the self-use and export) is also included because it has total PEF=1.0.

It should be noted that, to reduce the penalty for heat pumps, total PE was calculated without the ambient heat accounted as renewable energy, as would be required by EN ISO 52000-1. In principle, the heat extracted from outdoor air is RE, and therefore part of the total PE, with the amount of 33.4 kWh/m<sup>2</sup>·a. If it would be accounted, total PE value of AWHP would increase to 114.7 (81.3+33.4) kWh/m<sup>2</sup>·a. In the CO<sub>2</sub> emissions calculation, ambient heat has no meaning.

The ZEB requirement to fully cover with RE is fulfilled in case of DH, where **RE (68.1) fully covers non-ren PE (48.6)**. In the case of AWHP a slightly larger PV system would be needed (62.4 > 62.2). In the case of gas boiler, this requirement is practically not achievable.

Similar energy balance calculation for less insulated building is shown in **Table 3**.

To illustrate the energy balance differences in **Tables 2 and 3**, energy flows for AWHP cases are shown in **Figure 2**. If non-ren PE is calculated with **PV export**,

*Table 1. Primary energy factors and CO<sub>2</sub> emission coefficients.*

	non-ren PEF	renewable PEF	total PEF	kgCO <sub>2</sub> /kWh
Grid electricity & PV export	2.3	0.2	2.5	0.42
Natural gas	1.1	0	1.1	0.22
DH (district heat)	0.6	0.6	1.2	0.12
RE (solar, geo, ambient)	0	1	1	0



**fossil energy use is compensated by surplus of renewable energy in summer** –non-ren PE with export has exactly the same value for these cases. Therefore, to avoid this compensation, the export should not be accounted in the non-ren PE calculation. Non-ren PE value calculated with the self-use only is almost doubled in the case of less insulated building. Thus, **poor building envelope cannot be compensated with extensive PV if the non-ren PE is calculated with the PV self-use only**. In other words, this also means that ZEB energy performance can be controlled with this one indicator.

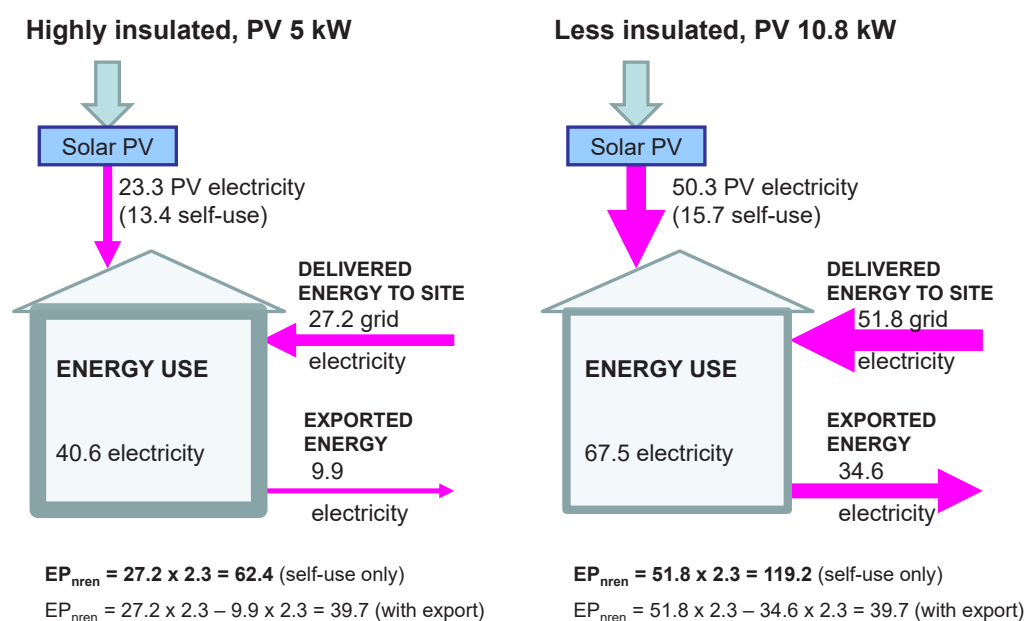
EPBD recast proposal (dd 2021-12-13) says that Member States shall take necessary measures to ensure that the energy use of a new or renovated ZEB complies with a **maximum threshold**. If we use data of highly insulated building in **Table 2**, it is possible to set the primary energy threshold that can be complied with AWHP and DH in between 40 and 120 kWh/h·m<sup>2</sup>, depending how the primary energy is calculated, see illustration in **Figure 3**. Here 40 kWh/h·m<sup>2</sup> represents non-ren PV with self-use only and 120 kWh/h·m<sup>2</sup> total primary energy where ambient heat is included. **Therefore, if EPBD will not specify that 'primary**

*Table 2. Energy calculation for highly insulated building with 5 kW PV.*

Energy balance	Energy need kWh/m <sup>2</sup> ·a	Energy use kWh/m <sup>2</sup> ·a		
		DH	Gas	AWHP
Space heating	38.5	46.3	43.9	16.6
DHW	25.0	27.8	26.3	13.5
Supply air heating <sup>1</sup> (electric)	5.0	5.0	5.0	5.0
Fans and pumps <sup>2</sup>	5.5	7.5	7.5	5.5
PV self-use		10.7	10.7	13.4
PV export		12.6	12.6	9.9
<b>Non-ren. primary energy, self-use only</b>		48.6	81.3	62.4
Non-ren. primary energy, export included		19.6	52.4	39.7
<b>Total primary energy, self-use only</b>		104.1	92.4	81.3
Total primary energy, exported included		85.2	73.5	66.4
<b>Renewable energy</b>		68.1	23.7	62.2
CO <sub>2</sub> emissions, kgCO <sub>2</sub> /m <sup>2</sup> ·a		4.4	10.9	7.2

<sup>1</sup>To ensure 18°C supply air temperature in cold winter and frost prevention conditions, ventilation unit is equipped with electric reheating coil after rotary heat recovery operating with frost prevention limit value for exhaust air temperature of 0°C.

<sup>2</sup>Fans and pumps include ventilation unit fan electricity (5.5) and electricity of circulation pumps (2.0). AWHP is calculated as a package where circulation pumps are included in space heating and DHW values.



**Figure 2.** Illustration of energy flows and non-ren PE calculation in cases with AWHP.

energy' means **non-renewable primary energy and its threshold needs to be calculated without compensation by PV export, it may lead to situation where ZEB requirements implemented in Member States may differ by factor 3 at the same performance level.**

It is important to understand that the primary energy threshold (first EPBD requirement) should refer to the use of grid electricity (and district heating/cooling) that could not be avoided by efficiency measures and on-site/community renewable energy production because there is not enough solar PV generation available in the winter and a building without seasonal electricity storage must use the grid electricity. Therefore, in this threshold, all non-renewable primary energy delivered to the site should be accounted that means that only the 'self-used' and used in 'other on-site uses' PV electricity can be subtracted in the non-renewable primary energy calculation, and exported PV electricity compensation should not be calculated because this occurs mainly in the summer. At the same time, the second EPBD ZEB requirement, to fully cover with renewable energy, differently accounts for the full amount of renewable energy. This is an important detail that renewable energy is calculated differently in these two ZEB requirements according to policy choices used in the EPBD recast proposal.

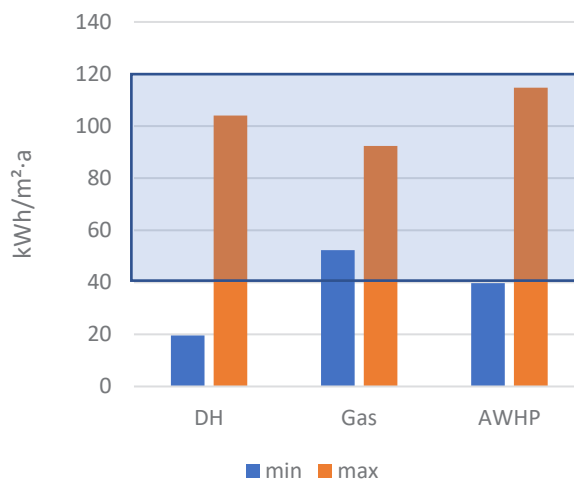
## Conclusions

Results show that current EPBD recast proposal (dd 2021-12-13) allows to specify the primary energy threshold (the first ZEB requirement) within extremely wide range – by factor 3 difference in the numeric value, depending on unspecified choices in the primary energy calculation. It was shown that this requirement

will become meaningful and poor building envelope cannot be compensated with extensive PV, if primary energy is calculated as **non-renewable** primary energy with subtracting only the amount of PV that is **self-used and used in other on-site uses**. At the same time, the second ZEB requirement of fully covering with renewable energy should be calculated differently, as current EPBD recast proposal comprises that all renewable energy including also exported energy is accounted. **Therefore, for consistent and transparent ZEB definition according to current policy choices these two small technical details, marked with bold, have a great importance and should be addressed.**

Apart from this essential conclusion regarding non-renewable primary energy inclusion it is important to

### ZEB primary energy threshold



**Figure 3.** Possible range of the primary energy threshold of 40 – 120 kWh/(m²·a) following EPBD recast proposal 2021-12-13, based on the highly insulated building data in Table 2.

**Table 3.** Energy calculation for less insulated building with 10.8 kW PV.

Energy balance	Energy need kWh/m²·a	Energy use kWh/m²·a		
		DH	Gas	AWHP
Space heating	77.0	92.5	87.7	33.1
DHW	25.0	27.8	26.3	13.5
Supply air heating (electric)	15.4	15.4	15.4	15.4
Fans and pumps	5.5	7.5	7.5	5.5
PV self-use		12.3	12.3	15.7
PV export		38.0	38.0	34.6
<b>Non-ren. primary energy, self-use only</b>		96.5	149.8	119.2
Non-ren. primary energy, export included		9.3	62.5	39.7
<b>Total primary energy, self-use only</b>		183.1	164.2	145.2
Total primary energy, exported included		126.2	107.3	93.4
<b>Renewable energy</b>		124.5	52.4	116.0
CO <sub>2</sub> emissions, kgCO <sub>2</sub> /m²·a		2.9	13.6	7.2



realise the following: EPBD recast proposal defines in article 9 that during the coming years all new (from 2030 onwards) and existing building step by step should reach ZEB by 2050. The assessment of ZEB can only be done in a reliable fashion with hourly calculation to overcome the mismatch of energy use and availability of renewable energy. Therefore, in

the longer run, hourly calculation methods should be required to be taken into use in all Member States. In this respect it is also important to note that with monthly or annual calculation energy balances, due to the averaging over longer periods, exported energy is disguised as self-use, which means: implicit, hidden compensation for exported energy. ■

## Opinion on deep energy renovation by REHVA Member

**B**uildings in the European Union use around 40% of the final energy consumption for their operation, but it is clear that this refers to existing ones. Based on this and taking in to account that around 85–95% of the existing buildings will continue to be used in 2050, the decarbonization should tackle seriously this group of objects. But first step to carbon-neutral buildings is considerable increase of energy efficiency.

If the primary energy consumption in building is reduced by at least 60%, it may be called deep energy renovations. To reach such a goal, the activities should include not only ensuring the required thermal insulation of building envelope and air tightness, but also the high efficiency of HVAC in building. In specific cases, the additional layer of thermal insulation is even not considered, especially if the payback time of investment costs is not satisfactory for the investors or building managers. In this light the crucial role plays the HVAC systems, which deliver above mentioned amount of energy to specific rooms in existing buildings. So, it is necessary to first increase the energy efficiency of the existing building as much as possible that is technically and economically justified, considering besides the energy renovation of the building envelope, renovation/

optimisation of all HVAC systems, and user education with the parallel improvement of IEQ and use of low embodied energy (carbon) materials. By this process the best available solutions should be used in order to be in line with preference of users and managers of existing buildings such as: easy implementation within the existing building and installed HVAC systems, minimal occupant disturbance during implementation, short implementation time in existing buildings, short payback time for investment costs and high potential for repeatability to other buildings.

Taking this in to account, it is important to address in this aspect all available HVAC systems and their components in specific buildings, particularly heating/cooling sources and main control systems, heating systems, domestic hot water systems, space cooling systems, ventilation systems and heat recovery.



**TOMASZ CHOLEWA**

Author of the REHVA Guidebook No. 32  
Lublin University of Technology, PZITS

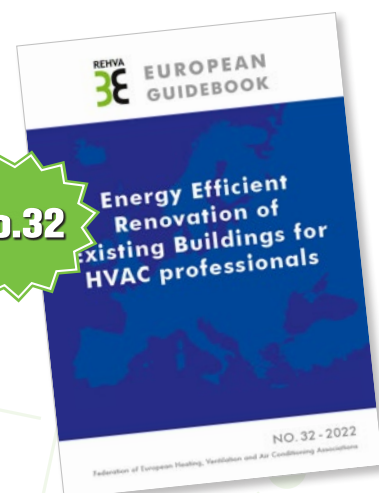
## REHVA EUROPEAN GUIDEBOOKS

### Energy Efficient Renovation of Existing Buildings for HVAC professionals

Energy Efficient Renovation of Existing Buildings for HVAC professionals.

This REHVA Guidebook shows the baseline for specific energy efficiency and other renovation measures in existing buildings for which the HVAC systems play an important role. It presents the best available techniques and solutions that can be used as part of the energy modernization of the HVAC systems.

REHVA  40 RUE WASHINGTON 1050 BRUSSELS, BELGIUM  
 +32-2-5141171  [INFO@REHVA.EU](mailto:INFO@REHVA.EU)  [WWW.REHVA.EU](http://WWW.REHVA.EU)



# The EPBD recast: *how to come to a transparent and fair ZEB definition*



**DICK VAN DIJK**

EPB Center expert, convener of ISO/TC 205 & TC 163 Joint Advisory Group on the set of EPB standards (EN ISO 52000 family)  
dick.vandijk@epb.center



**JAREK KURNITSKI**

REHVA Technology and Research Committee, Tallinn University of Technology

In the discussions on the definition and metrics for zero-emission buildings in the ongoing EPBD revision, several aspects have been covered in recent articles. In this article a new and simple metric is proposed that can be used for threshold values for “the very low energy demand” that is to be “fully covered by energy from renewable sources”. It can be used to safeguard a highly energy efficient building and, in combination with the main overall energy performance indicator, to set out trajectories towards a true zero-emission building (ZEB).

**Keywords:** EPBD recast, zero-emission buildings, threshold values, energy performance indicator, hourly energy performance calculations

## Introduction

In [2] Kurnitski addresses a variety of aspects of the EPBD recast proposal [1], including the definition of a zero-emission building (ZEB). More specifically, a series of calculation examples clearly demonstrate that ZEB threshold values should not be based on overall total primary energy (where “total” stands for all non-renewable *plus all renewable* primary energy, but on **overall non-renewable primary energy**).

In [3], Kurnitski and Zirngibl present additional examples that confirm the conclusions of [2] and where they continue with the focus on the impact of compensation of non-renewable primary energy use by export of surplus renewable energy generated on-site, as reward for replacing non-renewable electricity production in the grid. The EPBD proposal [1] states that for the threshold values the energy balance can be calculated on a “net annual basis”; ergo: non-renewable energy delivered to the building in winter can be ‘covered’ by a surplus of RE generated in summer. Kurnitski and Zirngibl conclude that the EPBD should be clear on this and replace the term “covered by RE” by “**compensated** by RE”. At the same time Kurnitski and Zirngibl point to the fact that an **additional requirement** is needed for the quality of the building, to avoid that a bad building quality is masked by compensation with exported renewable energy.

In [4] Kurnitski and Hogeling take the logical next step by addressing the negative impact of this compensation. Their examples prove that due to compensation a poorly insulated building can obtain the same high energy performance as a highly insulated building. They conclude that for the threshold values the primary energy should be calculated as **non-renewable** primary energy with subtracting only the amount of PV that is **self-used and used in other on-site uses**. This implies that also **hidden compensation** for exported renewable energy has to be avoided. With monthly or annual calculation energy balances, due to the averaging over longer periods, **exported energy is disguised as self-use**. Monthly or annual calculation leads to an overoptimistic energy performance and the non-renewable energy that has to be delivered to the building is severely underestimated. They conclude that, as a consequence, hourly calculation methods should eventually be required to be taken into use in all Member States.

## Compensation covers up non-renewable energy use

The question is, why **explicit** compensation (by rewarding exported renewable energy in the energy performance of a building) and **hidden** compensation (by monthly or “net annual basis” for the energy



balance calculation) is not (yet) banned. Two reasons can be imagined:

- (1) When there were only small amounts of renewable energy exported to the grid, these could be easily absorbed by the grid as a welcome renewable contribution, worth compensating by a reduction of the penalty for delivered non-renewable energy. But already nowadays we are faced with congestion in the grid: e.g. sunny hours where the price of electricity becomes even negative because the grid is overloaded with renewable energy from PV and wind.
- (2) It is feared that in e.g. Nordic climate ZEB is not reachable in a cost-effective way without resorting to this compensation (see also [3]). For the reason shown under (1) there must be another way to tackle this problem, because compensation:
  - (a) gives the **false impression** that no (or less) non-renewable energy is used,
  - (b) leads to the **wrong incentives**, and
  - (c) does not recognize and appreciate **smart designs**, where supply and demand are better matched by local storage and/or smart control of energy using equipment and appliances.

By the way, expressing the energy performance in terms of CO<sub>2</sub> emission makes no difference, because the same compensation mechanisms apply when using fixed CO<sub>2</sub> weighting factors instead of primary energy ones. So, also for the carbon balance it is important to stress that there should be no implicit or explicit compensation.

### Two problems, one solution: the residual energy to be delivered to the building site

So, two problems need to be solved:

- an **additional requirement** to safeguard the quality of the building is needed;
- if **truly ZEB** is not technically feasible, what would be a suitable metric, knowing that a ZEB based on compensation is not the way to proceed, because it obscures the goals and takes away the necessary triggers to progress towards real ZEB.

Let's go back to one of the key goals of the EPBD: *“The enhanced climate and energy ambition of the Union requires a new vision for buildings: the zero-emission building, the very low energy demand of which is fully covered by energy from renewable sources where technically feasible.”* ([1], recital 19).

A solution is to take *“the very low energy demand of the building which is to be fully covered by energy from renewable sources”* literally:

The building itself, as approached from the outside world, is as energy efficient as possible. This can be accomplished by limit values on the performance of the building envelope and technical building systems, complemented with a threshold value on -indeed- *“the very low amount of energy still required”*. This can be translated as the amount of residual energy needed for the EPB services that has **to be delivered ‘from elsewhere’**: how much heat and electricity should be delivered to the building from nearby (e.g. district heating/cooling) or distant (e.g. public grid). This is illustrated in **Figure 1**.

A few notes at this point:

**Note 1: it leaves open if the delivered energy is renewable or non-renewable:** the thermal energy and/or electricity may be (partly) non-renewable **now**, but evolve to more renewable sources **later**, during the lifetime of the building. On the other hand, if not converted to primary energy we are comparing apples and oranges. So primary energy factors have to be assigned. Since dynamic (hourly) primary energy factors are currently not available, we see two alternative options here, either to use primary energy factors 1 (because in the end it should be all renewable), which *de facto* means: take the delivered energy (this would be in favour for on-site heat pumps) or, to use generic non-renewable primary energy factors (to treat district heat and on-site heat pumps on equal basis) or perhaps better: to use weighting factors that are tailored to the national trajectories towards ZEB. This is a subject for (national) fine-tuning.

**Note 2:** So, it includes (whatever kind of) **energy** that has to be **delivered “from elsewhere”**: this strengthens its role as metric for an energy efficient building. Renewable energy needed from elsewhere is not taken for granted; it is not abundantly and freely available. While the optimum use of renewable energy sources available on-site is up to the owner of the building.

**Note 3: No compensation** for surplus of renewable energy produced on-site and exported to the grid<sup>1</sup>. Note (again) that in this metric, the *“very low amount of energy still required”* is really supposed to be **covered** and **not compensated** by renewable energy from ‘elsewhere’ (and yes: including the grid).

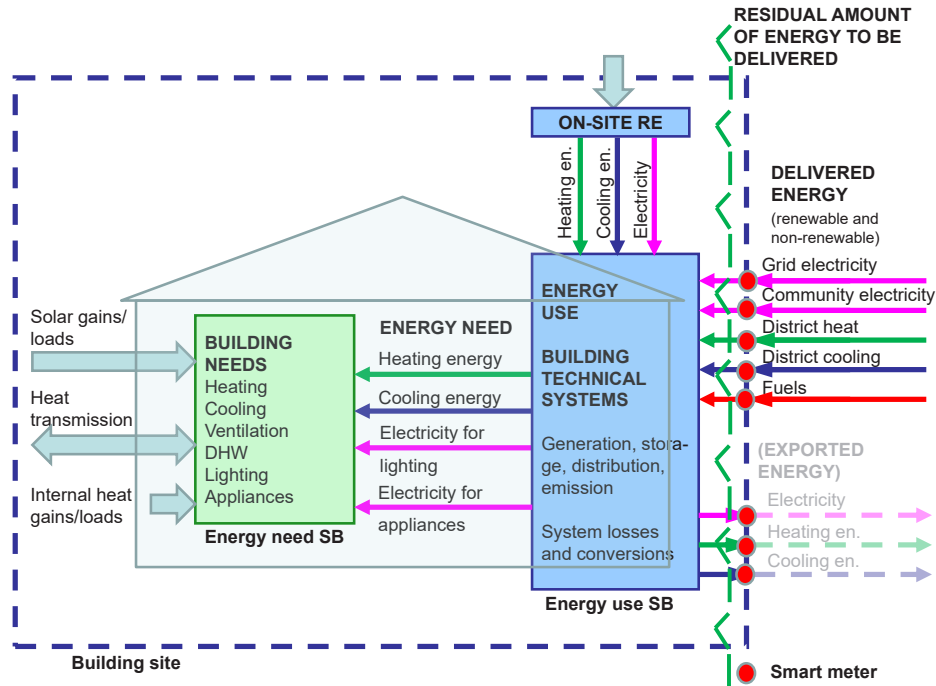
**Note 4:** According to EN ISO 52000-1 renewable energy produced on-site is also counted as energy delivered to the building through the assessment boundary<sup>2</sup>. When we take the *boundary for the residual energy still to be delivered*

1 In terms of the choices provided in EN ISO 52000-1 [6]:  $k_{exp}=0$

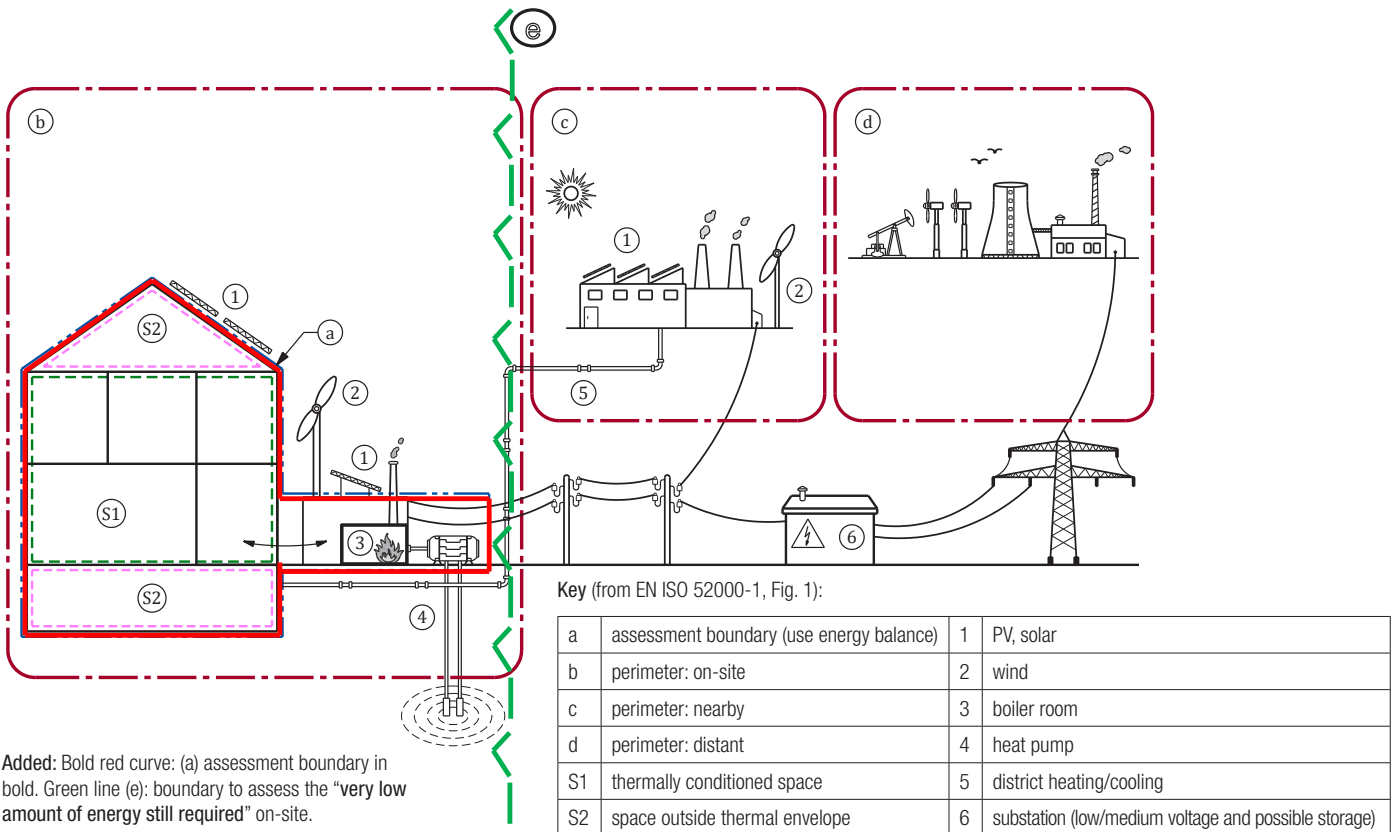
2 EN ISO 52000-1 assessment boundary is marked as Energy use System Boundary in **Figure 1** and is still needed for the calculation of the complete energy balance.

to the building site, the RE produced, processed and used on-site is already taken into account. Note that this is in line with the philosophy of EN ISO 52000-1 [6] that states “Inclusion or exclusion of energy contribution according to the perimeter (origin) depends on the calculation objective.”

**Note 5:** A big positive side effect of this proposal is that there is **no need to separately assess how much renewable energy is produced, processed and used on-site**. No discussion on whether and how to take free cooling by night ventilation into account or on what



**Figure 1.** The **boundary** proposed as metric for the very low amount of energy still required, which for a ZEB is to be covered by renewable energy.



**Figure 2.** Assessment boundary for the EP calculation according to EN ISO 52000-1 and the boundary for the residual energy still required.



to do with the heat extracted from ambient air by an air-water heat pump; no need to discuss whether to take the input or the output from a solar collector as renewable energy, etc.<sup>3</sup>: only how much energy is still needed from elsewhere is what counts.

**Note 6:** It must be stressed again that **(sub-)hourly calculations are necessary** to avoid hidden compensation and overoptimistic results. This is illustrated in **Figure 3**, derived from one of the publicly available **spreadsheets** at the EPB Center website (Laurent Socal, [5]) that, together with a series of extensive **Case study reports** and **short videos** supports the understanding and use of the set of EPB standards.

**Figure 3** clearly shows that by averaging over the whole day there seems to be only  $(9,88 - 7,88) = 2,0$  kWh electricity delivered from the grid, while the hourly balance reveals that in fact 9.88 kWh is delivered from the grid during that day. Actually, for a proper appreciation also the PEF and CO<sub>2</sub> values should be dynamic, to distinct summer versus winter and e.g. daytime versus evening; see note 4 in the next section.

Using a monthly energy balance, the underestimation of delivered non-renewable energy due to ignoring the hourly variation in demand and supply could be mitigated by a **generic correction (“matching”) factor**. But a generic matching factor does not reward

individual designs using smart technologies to better match demand and supply (summer-winter; daytime-evening), and to apply on-site storage.

Note that hourly calculation is also essential for assessing the indoor environment quality. E.g. a **thermal comfort indicator** is important to prevent that a high energy performance is at the cost of the quality of the indoor environment needed for healthy and comfortable living and working conditions.

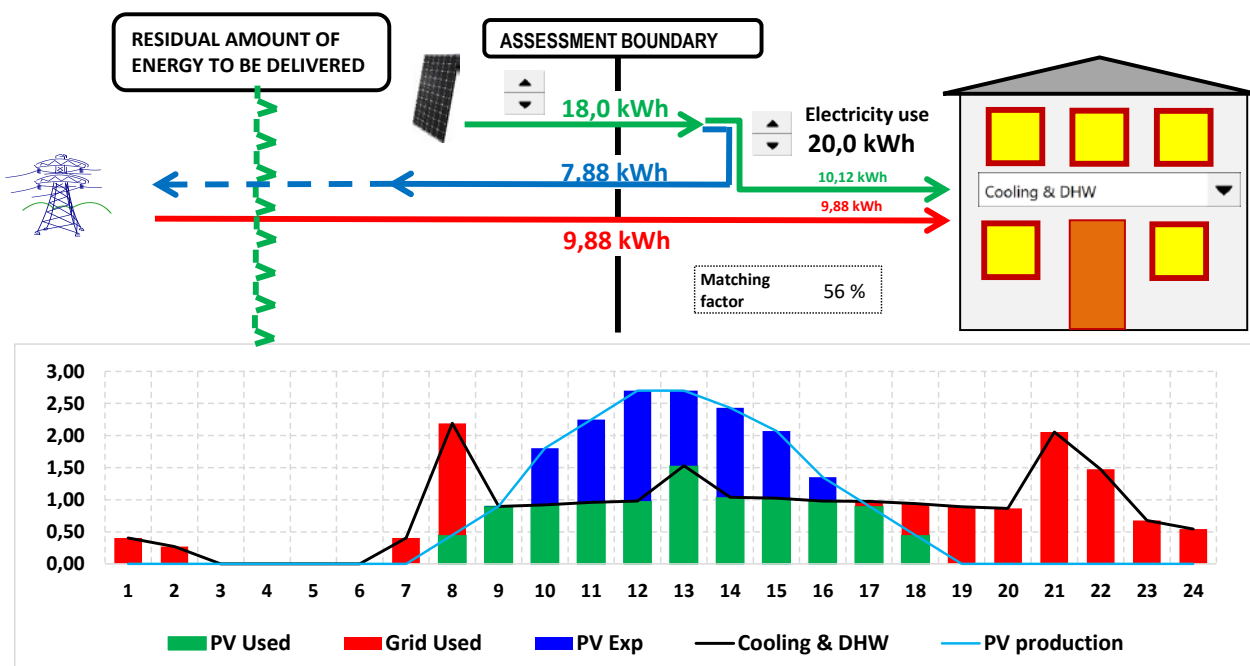
A short summary is given in **Table 1**.

### Main overall EP indicator: the non-renewable primary energy

Compare the indicator introduced above (see **Table 1**) with the main EP indicator: the non-renewable overall primary energy performance, see **Table 2**.

Again a few notes:

**Note 1:** In the EPBD proposal [1], **renewable energy communities and citizen energy communities** are listed as potential sources of renewable energy. In this context we should distinct between communities that have a physical connection dedicated to specific buildings and communities that are economic / contractual organizations that e.g. invest in renewable



**Figure 3.** Illustration of hourly PV mismatch (based on [5]) but updated).

<sup>3</sup> For the same reason, but also because renewable energy should by priority be used where high energy efficiency is difficult, the Renewable Energy Ratio (RER) is an indicator that can lead to irrational choices.

energy production for the public grid or dedicated to other users (e.g. industry). Only if there is a **permanent and dedicated physical connection**, the energy community can be regarded as a specific source. It is then at the same level as district heating and cooling. Without such connection, it would lead to double counting: as RE source for the specific building and as RE source for the public grid <sup>4</sup>.

**Note 2: Renewable energy from the electric public grid** is an eligible source to assess the EP of the building. In the EPBD proposal [1] only sources on-site and nearby are listed. This seems to be given in by the focus on the improvement of the building and its nearby provisions. But looking from a macro perspective it is evident that autarkic buildings are not the goal, so renewable energy from the grid is included here.

**Note 3:** Again: **hourly calculation** is necessary to avoid hidden non-renewable energy use, overoptimistic EP and lack of incentives, recognition and appreciation for smart design.

**Note 4:** For a really proper appreciation the **PEF and CO<sub>2</sub> values should be dynamic**, to distinct summer versus winter and e.g. daytime versus evening: the hourly and monthly variation of supply and demand of the building and the hourly and monthly variation of supply and demand of renewable energy in the grid are all taken into account simultaneously. On-site or nearby energy storage is rewarded as well as smart use of equipment, leading to use of energy from the grid when there is sufficient renewable energy in the grid and export of own produced renewable energy to the grid when the grid has a large demand.

*Table 1. The very low amount of energy to be delivered to the building site.*

The residual energy to be delivered to the site		Comment
<b>Boundary:</b>	The building site	with the building site being zero carbon from fossil fuel
<b>Main purpose:</b>	Metric for "Highly energy efficient building" and indication how much energy still to be delivered from nearby and/or distant	<b>threshold values</b> as function of climate and building category (= conditions of use, occupancy pattern, internal gains, ...)
<b>PE factors:</b>	For the primary energy still required and [eventually] to be fully renewable in the future. PEF values to be fine-tuned, see text above (Note 1)	<ul style="list-style-type: none"> <li>the sources are not defined at the building site boundary</li> <li>in the future these should be 100% renewable: see main text</li> </ul>

*Table 2. The non-renewable primary energy performance indicator.*

The non-renewable primary energy performance ( $EP_{Pnren}$ )		Comment
<b>Boundary:</b>	on-site + nearby + distant	Including the public grid
<b>Main purpose:</b>	the main EP indicator	keeping in mind that still several important choices are to be specified to unify this indicator; see e.g. U-CERT project [7]
<b>PE factors:</b>	Heat and electricity, for nearby (physically connected RE energy communities, district heating and cooling) and distant	At policy level trajectories can be given for the transition of nearby and distant sources towards 100% renewable before 2050; see main text below.

<sup>4</sup> This is in line with EN ISO 52000-1 Table B.23, *Specification of nearby perimeter*:

- Biofuels (liquid or gaseous): Connected to the same branch of the distribution network or having a dedicated connection, requiring specific equipment for the assessed object to be connected to it
- Electricity: Connected to the same branch of the distribution network, meaning medium voltage or lower
- District heating/cooling: always nearby



Monthly PEF values, instead of hourly, take away the extra stimulus to optimize the interaction with the grid with respect to hourly peaks and overloads / congestion. Annual PEF values miss the opportunity to boost initiatives aiming at a better distribution of renewable energy production over the seasons.

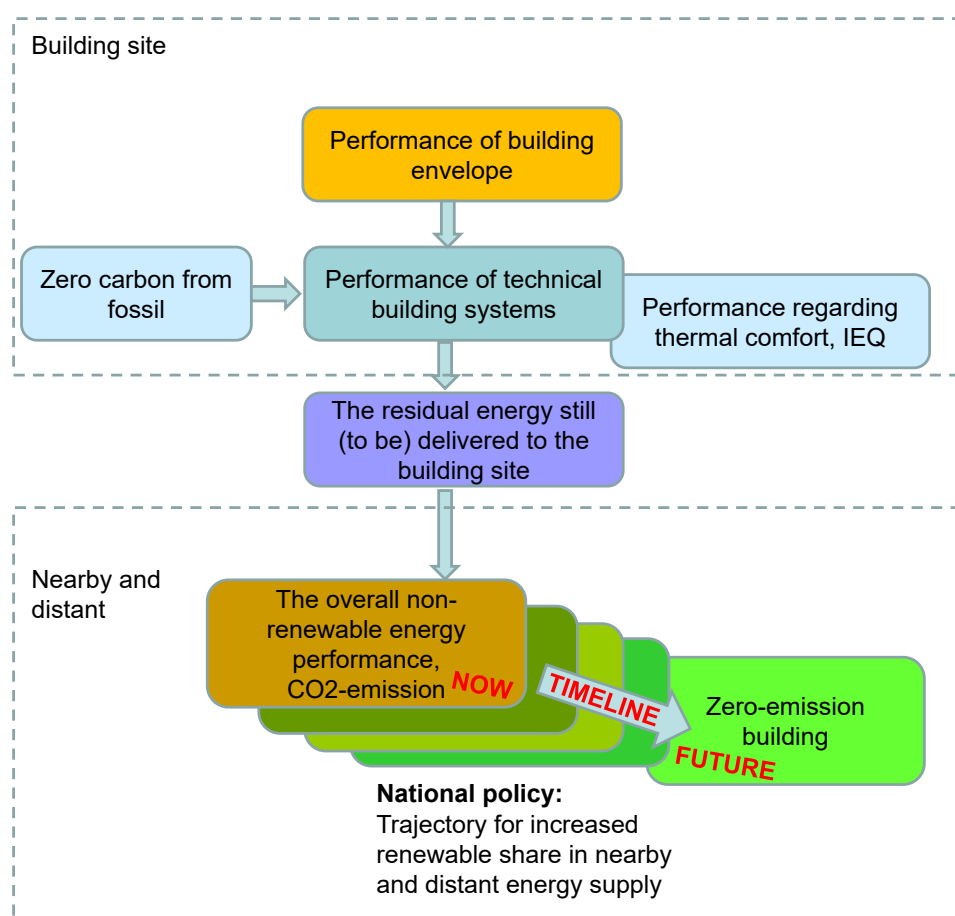
**Note 5:** According to the current EPBD proposal ‘self-used’ is defined as the part of on-site produced renewable energy used by on-site technical systems for EPB services. While ‘other on-site uses’ is defined as the energy used on-site for uses other than EPB services, and may include appliances, lighting in dwellings, miscellaneous and ancillary loads or electro-mobility charging points.

And ‘exported energy’ is defined as, expressed per energy carrier and per primary energy factor, the proportion of the renewable energy that is exported to the energy grid instead of being used on site for self-use or for other on-site uses.

It makes sense to make the distinction between ‘other on-site uses’ and ‘exported energy’, because “**export**” of a surplus of on-site produced renewable energy **to the ‘other on-site uses’ does not interfere with the grid**. And because covering (part of) the ‘other on-site uses’ leads to a **real decrease of the amount of electricity taken from the grid**, it should be deductible from the electricity to be delivered from the grid for the EPB services. In contrast with exported renewable energy to the grid, it is not disguising or compensating delivered non-renewable energy! Of course the maximum that can be deducted is 100% of the amount of ‘other on-site uses’, at the given (sub-) hourly time interval.

### Finally: illustration of the suggested successive steps

A diagram to illustrate the successive steps is given in **Figure 4**.



**Figure 4.** Diagram illustrating the suggested successive steps.

### Conclusion

In the discussions on the definition and metrics for zero-emission buildings in the ongoing EPBD revision, several aspects have been covered in recent articles. In this article a new and simple metric has been proposed that can be used for threshold values for “the very low energy demand” that for a zero-emission building (ZEB) is to be “fully covered by energy from renewable sources”. It can be used to safeguard a highly energy efficient building and, in combination with the main overall energy performance indicator, to set out trajectories towards a true zero-emission building (ZEB).

### Acknowledgements

The authors like to thank Laurent Socal and other EPB Center experts for their valuable input and critical comments.

### References

Please find the complete list of references in the htm-version at <https://www.rehva.eu/rehva-journal> ■

# CLIMA 2022 conference papers on the theme ENERGY

The following papers have been acknowledged as high ranking on the theme ENERGY.

Included in this issue:

## **Going active How do people envision the next generation of buildings?**

Elli Nikolaidou, Ian Walker, David Coley, Stephen Allen, Daniel Fosas  
(Best paper award for the theme Energy)

## **Performance of a mixed-use ground source heat pump system in Stockholm**

Jeffrey D. Spitler, Signhild E. A Gehlin

## **Design of highly compact indirect evaporative coolers**

Francisco Comino, Jesús Castillo-González, Francisco J. Navas-Martos, Pablo E. Romero, Manuel Ruiz de Adana

## **A common European EPB Assessment and Certification scheme. U-CERT's proposal**

Pablo Carnero, Dick van Dijk, Niccolo Mignani, Gabriela Ana

The other papers can be accessed on-line:

## **Intelligent building envelope solutions in Finnish new and old apartment buildings**

Azin Velashjerdi Farahani, Juha Jokisalo, Natalia Korhonen, Kirsti Jylhä, Heikki Ihasalo, Jaakko Ketomäki, Risto Kosonen

This study investigated the effects of intelligent building envelope solutions (automated blinds, openable windows, and awnings as well as electrochromic windows) in Finnish old and new apartment buildings. Moreover, the results are compared to the passive solutions (manual blinds and solar protection windows). The main goal was to compare the performance of each solution in improving the indoor temperature conditions in Finland's current climate.

<https://proceedings.open.tudelft.nl/clima2022/article/view/438>

## **Potential of WASTE WATER HEAT RECOVERY in reducing the EU's energy need**

Pavel Sevela, Johannes Frenger, Jürgen Schnieders, Rainer Pfluger

Waste-Water Heat-Recovery (WWHR) technology was identified as the most promising technology to unlock the under-addressed potential in reducing the energy need for water heating.

Particularly interesting application of WWHR is for showering, which accounts for about 70 to 82% of the daily residential hot water tapping profile. Shower-wise installed heat-exchangers offer a cost-effective way of utilizing otherwise wasted heat for preheating cold fresh water, thus reducing the temperature span covered by the water heater. The total energy demand savings for hot water heating can be up to 40%.

<https://proceedings.open.tudelft.nl/clima2022/article/view/439>

## **Advanced solutions to improve heat recovery from wastewater in a double heat exchanger**

Mihnea Sandu, Aamjed Albaiyati, Ilinca Nastase, Paul Danca, Florin Bode, Cristiana Croitor

Usually, heat recovery from wastewater is designed to recover residual energy from the hot drainage water and this recovered energy is used to preheat incoming cold water or to heat pumps. The paper presents numerical simulations using a SST  $k-\omega$  turbulence model in order to compare a regular geometry with a helicoidal one. The second one provides a more turbulent flow that allows an intensification of the outer flow, thus allowing the enhancement of the heat transfer from the inner heated flow to the outer flow.

<https://proceedings.open.tudelft.nl/clima2022/article/view/429>

## **Optimal design and operation for heat prosumer-based district heating systems**

Haoran Li, Juan Hou, Natasa Nord

This study aimed to break this economic barrier by introducing water tank thermal energy storage (WTTES) and optimizing the operation of heat prosumers with WTTESs, considering the widely used heating price models in Norway. Firstly, a generalized heating price model was introduced, which could represent the current widely used heating price models in Norway. Secondly, the WTTES was integrated into the heat prosumer to improve the self-utilization rate of the prosumer's heat supply from its distributed heat sources, meanwhile, shave the prosumer's peak load.

<https://proceedings.open.tudelft.nl/clima2022/article/view/347>

## Concise cycle test methods to evaluate heating/cooling systems with multiple renewable sources

Robert Haberl, Maike Schubert, Thibault Péan, Iván Bellanco, Francisco Belio, Jaime Salom, Daniel Carbonell

The goal of the project TRI-HP is to develop systems based on electrically-driven natural refrigerant heat pumps coupled with photovoltaics to provide heating, cooling and electricity to multi-family buildings with an on-site renewable share of 80%. The implementation of different energy sources for such a system often leads to a complex architecture of the overall system. The performance evaluation of such systems is not trivial and cannot be done via steady-state measurements of individual components. Instead, dynamic measurements using the hardware in-the-loop approach are performed to test the performance of the newly developed system

<https://proceedings.open.tudelft.nl/clima2022/article/view/390>

## Biomass in District Energy Systems Overview and Perspectives for an Italian Case-Study

Lorenzo Teso, Tiziano Dalla Mora, Piercarlo Romagnoni

This work focuses on the use of district heating networks supplied with energy from biomass as a form of sustainable development for cities and communities, with attention to the Italian situation. To demonstrate how the use of biomasses in district energy networks represents a valid alternative to fossil fuels an analysis of the utilization of forests for wood harvesting in the Italian energy sector is carried out, showing how greenwoods and forests can withstand even greater exploitation for the collection of wood material for energy production. In order to prove the feasibility of the switch, a case study district, representative of the Italian residential building stock, is analysed.

<https://proceedings.open.tudelft.nl/clima2022/article/view/398>

## Next-Generation Energy Performance Certificates, What novel implementation do we need?

Lina Seduikyte, Phoebe-Zoe Morsink-Georgali, Christiana Panteli, Panagiota Chatzipanagiotidou, Koltsios Stavros, Dimosthenis Ioannidis, Laura Stasiulienė, Paulius Spudys, Darius Pupeikis, Andrius Jurelionis, Paris Fokaides

This study performed under the H2020 project "Next-generation Dynamic Digital EPCs for Enhanced Quality and User Awareness (D<sup>2</sup>EPC)", aims to analyze the quality and weaknesses of the current EPC schemes and aspires to identify the technical challenges that currently exist, setting the grounds for the next generation dynamic EPCs.

<https://proceedings.open.tudelft.nl/clima2022/article/view/348>

## Heat recovery ventilation solutions for school building renovation case study

Helena Kuivjõgi, Henri Sarevet, Martin Thalfeldt, Jarek Kurnitski

Two solutions with different cost are studied in this paper: classroom air handling unit (AHU), and central AHU. The aim of this study is to determine which solution is better in energy

efficiency if there is demand to renovate ventilation system in school building. The calculations have been done in standard and real use and climate. Study will show the cost-optimality of these solutions in school buildings.

<https://proceedings.open.tudelft.nl/clima2022/article/view/208>

## Benchmarking the measured energy use of Nordic residential buildings and their Zero Energy-readiness

Andrea Ferrantelli, Martin Thalfeldt, Jarek Kurnitski

Building energy benchmarking provides information to stakeholders and motivates energy retrofits, by evaluating and comparing a building to similar units and/or to a reference building in terms of energy consumption with the minimum amount of data possible.

In this paper nearly 19000 Estonian Energy Performance Certificates (EPCs) of detached houses have been analysed. By means of a systematic statistical investigation, we determined the time evolution of EPC labels and evaluated the impact of incentives pre/post renovations, drawing a comprehensive and updated picture of the Estonian detached houses.

<https://proceedings.open.tudelft.nl/clima2022/article/view/171>

## Assessment of Use Cases Involving Data from the Energy Performance Certification Process for Buildings - From Individual Buildings to Regional Scale

Gerfried Cebrat, Alessandra Manzini, Christiana Panteli, Claudia Julius

The main objective of this paper is to analyse use-cases which are based on data from the Energy Performance Certification (EPC) process. This data, which is often collected for compliance checks by authorities, can be used exploited for multiple purposes. The most basic service is energy consulting by engineers, based on a living document from the EPC process, depicting the buildings thermal characteristics and specification of the HVAC system. But also, the design of regional decarbonization can be data driven, and the drafting of energy policies supported, investigating effect of renovation and decarbonization incentives.

<https://proceedings.open.tudelft.nl/clima2022/article/view/112>

## From Diesel to Electric to NZEB, an Energy Performance Contract in a Hotel

João Raposo, Daniel Silva, António Mortal, João Lopes

How could a 1975 4\* 220# bedroom beach hotel evolve from an old system with Diesel Boiler and cooling only chiller to become a NZEB building. An Energy Performance Contract, funded by innovation funds, a hotel in south Portugal obtained 60% Energy reduction, a new Chiller and integrated Heat Recoveries results on eliminating diesel consumption with almost free Sanitary Hot Water in the summer and next steps to achieve a NZEB Building. Energy Performance Certificate came from D to B which is already considered NZEB in Portugal.

<https://proceedings.open.tudelft.nl/clima2022/article/view/28>





This paper has been awarded as best paper under the Energy theme by CLIMA 2022 scientific committee

Copyright ©2022 by the authors. This conference paper is published under a CC-BY-4.0 license.

# Going active: How do people envision the next generation of buildings?

**ELLI NIKOLAIDOU**Department of  
Architecture and  
Civil Engineering,  
University of Bath,  
Bath, United Kingdom**IAN WALKER**Department of  
Psychological  
Sciences, University  
of Surrey, Guildford,  
United Kingdom**DAVID COLEY**Department of  
Architecture and  
Civil Engineering,  
University of Bath,  
Bath, United Kingdom**STEPHEN ALLEN**Department of  
Architecture and  
Civil Engineering,  
University of Bath,  
Bath, United Kingdom**DANIEL FOSAS**School of Engineering,  
University of Edinburgh,  
Edinburgh, United  
Kingdom**Keywords.** Active Buildings, decarbonisation, stakeholder engagement.**DOI:** <https://doi.org/10.34641/clima.2022.325>

## Abstract

With several countries having declared a climate emergency and set decarbonisation targets, the built environment is expected to change radically. Several building standards have been developed to reduce carbon dioxide emissions from buildings, but they do not provide a clear pathway to a net zero future. The recently launched Active Building Code (ABCCode) offers guidance on minimising the environmental impact of the next generation of buildings termed Active Buildings (ABs). This is achieved through their synergistic relationship with the grid. This paper presents our two-stage investigation into the stakeholder perceptions of ABs. In stage 1, we collected thoughts on the future of the built environment through a series of online focus group discussions with 30 industry experts. In stage 2, we quantified the ideas that arose

from stage 1 through an online survey of 30 academics and researchers. Participants answered four questions, namely: (i) what is missing from existing regulations and standards; (ii) what is an AB; (iii) how should the performance of ABs be assessed; and (iv) what are the challenges to the popularisation of ABs. The data that was collected from the focus groups and the survey was analysed visually and statistically using logistic regression to identify the aspects stakeholders find important when envisioning the next generation of buildings. No significant differences were, in general, observed between the two groups, with industry and academia agreeing that whole-life carbon, energy demand, and energy flexibility should be used for the performance assessment of ABs – therefore aligning with the metrics suggested by the ABCCode. Both groups interpreted ‘activeness’ as responsiveness, with industry experts

highlighting the need to better define the relationship between buildings and the grid. They also regarded people's mindset as the biggest challenge faced by ABs, due to the general tendency to make decisions based on capital cost. Academics and researchers also worried about the cost of technologies involved, which is however expected to drop over time. Results should be used to inform regulations and standards to make sure these are comprehended by all stakeholders and ultimately drive down carbon on all building projects.

## 1. Introduction

With human-induced global warming having caused multiple changes in the climate system [1], several countries have now declared a climate emergency. To act on it, countries will have to shift onto a path of decarbonisation, setting targets and timelines for net zero carbon. Countries will thus have to achieve a balance between the amount of carbon they add to the atmosphere and the amount they remove from it [2]. Aiming to achieve such a balance and ultimately stop its contribution to global warming by 2050, the UK was the first major economy to pass a net zero emissions law [3]. The building sector is expected to play a critical role in reaching this net zero target, as buildings are associated with approximately 40% of total carbon dioxide (CO<sub>2</sub>) emissions in Europe [4]. However, reports produced by experts, such as the LETI Climate Emergency Design Guide [5], state that current building regulations are seriously lagging behind the trajectory required to achieve net zero and stop global warming. In a similar way, voluntary building standards do not push the decarbonisation agenda far enough, as they do not always encourage holistic solutions, nor do they offer incentives for well-performing buildings [6].

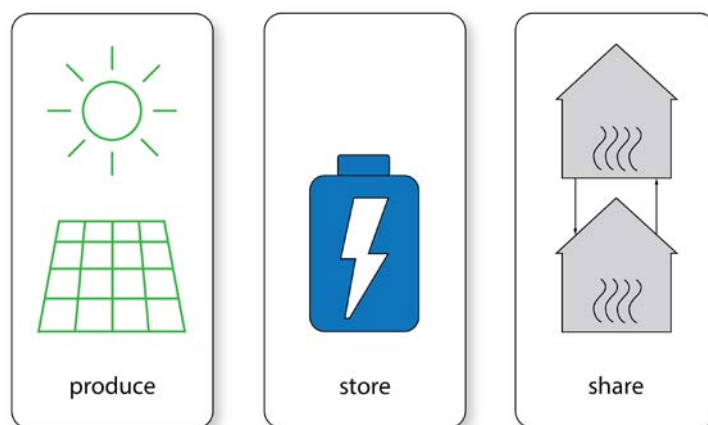
In more detail, buildings commonly draw the energy they require to satisfy the needs of their occupants from the grid. Hence, they are commonly regarded as passive users of energy, not as active parts of the energy infrastructure. Thanks to technologies such as solar panels and batteries, buildings are however able to support a bi-directional relationship with the grid. Such a relationship can provide the grid with a greater energy flexibility, which is vital to meeting net zero – given the time-varying renewable energy generation [7]. Active Buildings (ABs) aim to exploit this missed opportunity [8]. These are buildings that produce, store, and share energy (**Figure 1**) based on the needs of their occupants, as well as of the grid [9]. Thanks to their active interaction with the grid, ABs can help both the building and energy sectors reach

net zero. At the same time, such a synergetic relationship can reduce peak demands and thus the need to invest in energy infrastructure. It can also transform building occupants into prosumers (that is, producers and consumers of renewable energy) and hence reduce their energy bills.

If we are to adopt such an approach, stakeholders would need some form of guidance on what an AB is and how its performance should be assessed during the design and in-use stages. The easiest way to do this would be via some form of building code. Given that building technologies and energy infrastructure are rapidly evolving and that creativity in design is necessary, any proposed Active Building Code needs itself to be active – i.e., to evolve over time. ABCode1 is our initial proposition for an Active Building Code (ABCode) [10]. Additional iterations (e.g., ABCode2, ABCode3, etc.) may emerge in the future to account for any advances in the building and energy sectors, and ensure that we are on track for decarbonisation.

This paper presents our two-stage investigation into the stakeholder perceptions of the next generation of buildings called Active Buildings (ABs), aiming to:

- 1) Identify the aspects that are missing from existing regulations and standards, which should be accounted for when developing or revising relevant frameworks;
- 2) Justify our initial proposition for an Active Building Code (ABCode) and provide a clear definition of ABs and a suitable framework for assessing their performance; and
- 3) Identify the barriers to the popularisation of ABs, which should be dealt with by future iterations of the ABCode.



**Figure 1.** Going active: Produce, store, and share energy.

## 2. Research Methods

Section 2 describes the data collection and analysis process applied in this study.

### 2.1 Data collection

The first stage of our investigation aimed to help us get an insight into industry thinking. The focus group method was used, as this is recommended for cases where researchers wish to get a feel for an emerging topic, and an understanding of what is important to a given population [11] – but may not yet know what questions must be asked quantitatively [12]. Twelve focus group discussions were conducted, with each group comprising two or three industry experts and the moderator/facilitator (i.e., one of the authors of this paper). These were decided to be online – and not face-to-face – due to COVID-19. Online focus group discussions are accompanied by great savings in time, cost, and CO<sub>2</sub> emissions [13].

Each discussion lasted for approximately one hour. Initially, participants briefly introduced themselves. They then engaged in a general discussion about the future of the built environment in view of the net zero target – including the extent to which existing building regulations and standards support such a target. Finally, they participated in a more specific discussion about ABs, providing their definition of ‘active’ without having any knowledge of the term. They also shared their thoughts on the performance assessment of ABs, as well as on the barriers to their acceptance. Each of the sessions was videorecorded upon agreement of all participants, with the help of Microsoft Teams. As focus group discussions do not seek to sample representatively from a population, participants were all selected on the basis of their extensive experience within the building and energy sectors. In particular, they are experienced industry practitioners across the whole value chain, having a variety of backgrounds and work experience (i.e., architecture, engineering, sustainability consulting, energy management, and housing development).

This sampling strategy is called purposive sampling, as participants are selected purposely to yield rich information [14]. 30 industry experts were recruited in this study. The total number of participants – and therefore of focus groups – was dictated by the so-called ‘saturation point’; i.e., the point at which no new information was emerging from the discussions [15]. An initial round of five focus groups were here conducted. As no saturation was reached, additional participants were recruited, and a second round of seven focus groups were conducted – until no new information was emerging. Regarding

the size of the groups, a low number of participants per group was here selected due to the complexity of the topic. In more detail, triads and dyads were preferred as they offer a balance between the individual and the group context, and therefore allow participants to become familiar with the topic and reflect on what they hear from others [16].

The second stage of our investigation aimed to help us get an insight into academic thinking. An online survey was used, as this would help us quantify the ideas that emerged from the first stage (i.e., the focus group discussions). The survey included four closed-ended questions to reflect the themes that emerged from the discussions with the industry experts. The options that were given to participants reflected the most popular responses among the industry experts. The survey was completed by a total number of 30 academics and researchers, who had the freedom to select up to two options per question.

### 2.2 Data analysis

Grounded Theory was here used to analyse the data that was collected from the focus group discussions in the first stage of our investigation. This is a well-known approach to theory generation, developed by Barney Glaser and Anselm Strauss in the 1960s [15]. After becoming familiar with the data by listening to all the recordings and keeping notes, we completed the coding step by attaching labels to text segments. Coding was essential for generating core categories (themes), which can provide an easily recognisable description of any valuable data. Four themes arose through constant comparison (i.e., the definition of codes and their comparison to previously identified codes). These were then expressed in the form of questions (as presented in Section 3) – which were subsequently posed to academics and researchers through an online survey in the second stage of our investigation. The data that was collected from the focus group discussions and the survey was analysed visually (in Python), and statistically (in R, using a logistic regression model).

Focusing on the statistical analysis of the responses, a generalised linear model was here used to predict the binary outcome (i.e., whether a specific option is selected by a person, or not). The *lme4* package for R and, in particular, its *glm()* function was used to fit such a model and to analyse the fitted model. The fitted model revealed the interaction or not between options and the two groups of stakeholders. That is, it showed whether industry experts, and academics and researchers, tend to respond in a different way, or not. Note that, analysis automatically used the first option (i.e., the



first label of the x axis in **Figures 2–5**) as the reference category. It then showed whether the rest of options are significantly different from it, or not. In other words, each pair of responses (i.e., of blue and green circles in **Figures 2–5**) was compared to the reference category. Finally, the odds ratios from the binary logistic regression were calculated in R using  $\exp(\text{model\$coefficients})$  to demonstrate the options that are more likely to be voted for by any stakeholder – and that should be hence prioritised when designing the next generation of buildings. It is worth pointing out that conclusions refer to the collected data. In the future, additional observations could be collected to boost statistical power.

### 3. Results

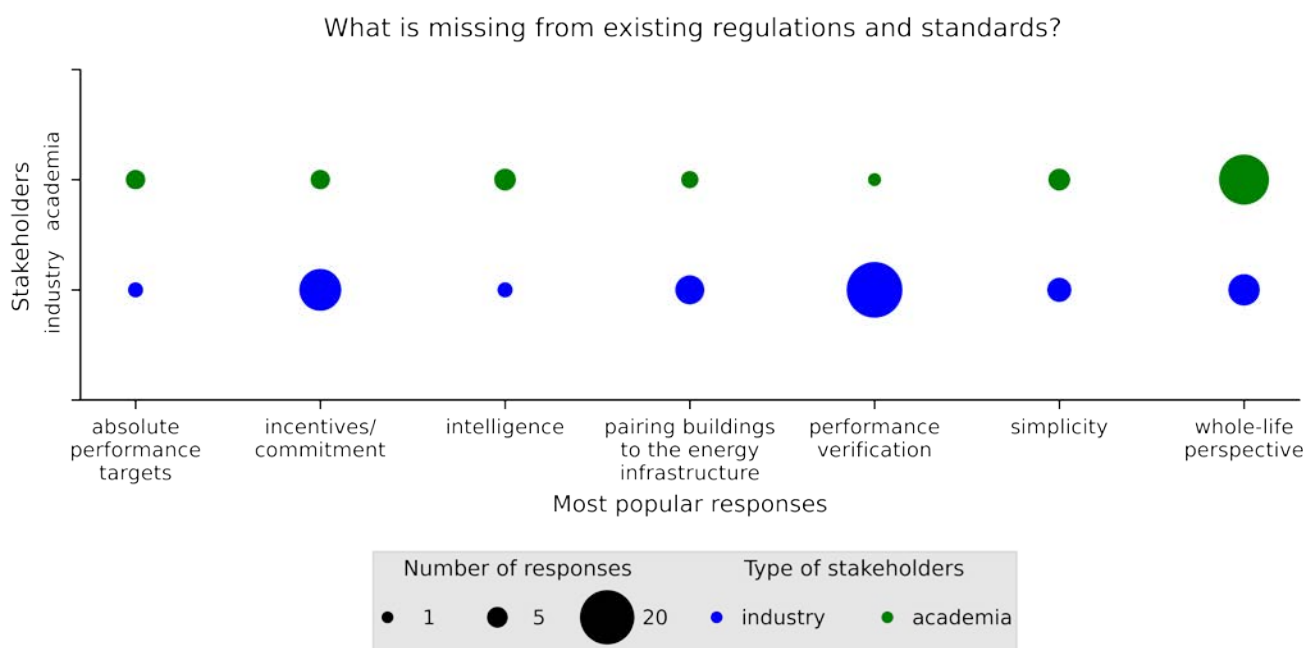
Section 3 presents results in the form of four major themes. These express the topics that emerged from the online focus group discussions with the industry experts. They also reflect the close-ended questions that were then posed to academics and researchers. These had the freedom to select up to two responses (among the most popular responses provided by the industry experts, as shown on the x axis in **Figures 2–5**).

#### 3.1 Theme 1: What is missing from existing regulations and standards?

The great majority of the industry experts regarded *performance verification* as the aspect that is mainly missing from regulations and standards (**Figure 2**). In more detail, all focus groups brought to discussion

the lack of a compulsory scheme for post-occupancy evaluation for all building types, expressing worry that this may prevent buildings from achieving net zero carbon in operation. The second most popular response was *incentives/commitment*. Almost half of the industry experts stated that the current lack of carbon incentives does not motivate stakeholders to invest in greener solutions. Another omission is that there is not any agreement that forces stakeholders to commit to a high level of performance in use. In the case of academics and researchers, none of these two aspects were popular responses, as they were voted by one and four persons, respectively. *Whole-life perspective* was the most popular response for these stakeholders, who appear to believe that the whole-life performance of buildings is not dealt with sufficiently by existing regulations and standards.

Focusing on the statistical analysis of responses, the logistic regression model in R indicated that options and groups interacted significantly in the case of the following options: *performance verification* (p-value = 0.002); *incentives/commitment* (p-value = 0.03); and *pairing buildings to the energy infrastructure* (p-value = 0.05). This implies that, in these occasions, academics and researchers responded significantly differently from industry experts – using *absolute performance targets* as the reference category. The analysis also showed that these three options as well as *whole-life perspective* were significantly different from the reference category. The calculation of the odds ratios confirmed the popularity

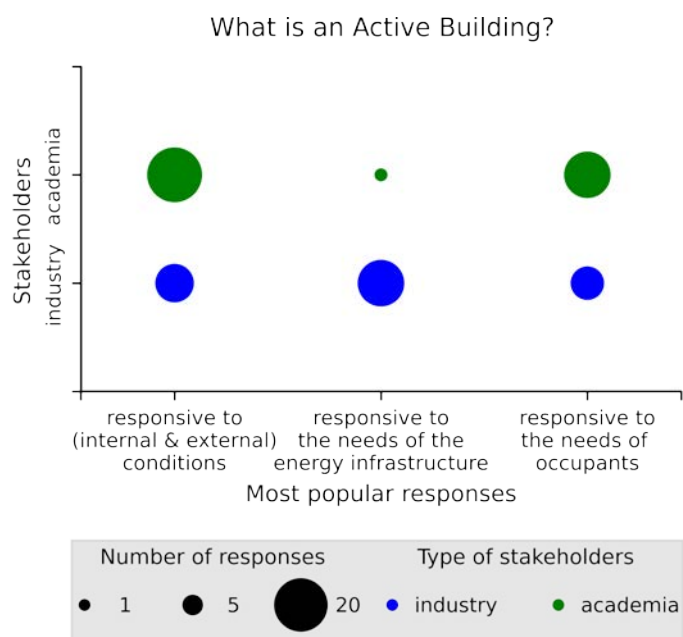


**Figure 2.** The aspects that are missing from existing regulations and standards, according to the 30 industry experts (blue) and the 30 academics and researchers (green).

of performance verification, commitment, whole-life perspective, and pairing buildings to the energy infrastructure. In more detail, it showed that the odds of someone voting for these options are greater than the odds of someone voting for *absolute performance targets* by a factor of 21, 10.71, 6, and 5.1, respectively.

### 3.2 Theme 2: What is an AB?

When asked to provide their own definition of active without any prior knowledge of the term, industry experts highlighted the importance of designing and delivering buildings that are *responsive to the needs of the energy infrastructure* (Figure 3). ABs should thus be active parts of the grid, playing an important role in its decarbonisation and also minimising its need for upgrade – which can be very expensive. Around one third of the industry experts connected the term ‘activeness’ with the *responsiveness to internal and external conditions*. ABs are thus expected to directly respond to inputs, such as the weather, with the aim of optimizing building energy performance. Another interpretation of activeness was the *responsiveness to the needs of occupants*. ABs are hence expected to interact with their end users to satisfy their needs, such as heating and cooling, and ultimately maximise their health and wellbeing. This was chosen by half of the academics and researchers who participated in the survey, while the *responsiveness to the needs of the energy infrastructure* was selected by only one academic. The *responsiveness to conditions* was the most popular response for this type of stakeholders.

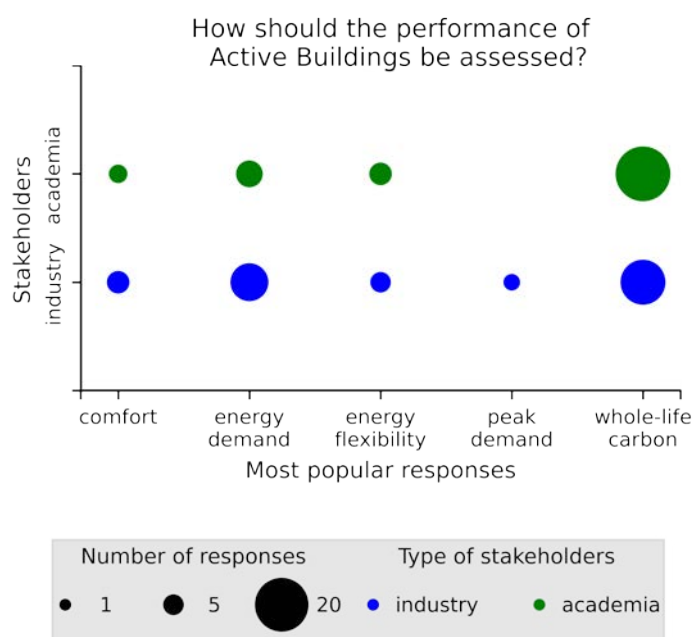


**Figure 3.** The definition of an Active Building, according to the 30 industry experts (blue) and the 30 academics and researchers (green).

The logistic regression model in R showed that the interaction between options and groups was highly significant just in the case of the *responsiveness to the needs of the energy infrastructure* (p-value = 0.0004). This is thus the only occasion where academics and researchers responded significantly differently from industry experts. No other significant difference was found as none of the options is significantly different from the reference category (as a pair of responses). The calculation of the odds ratios suggested that the odds of someone voting for the *responsiveness to the needs of the energy infrastructure* are slightly greater than the odds of someone voting for *responsiveness to internal and external conditions* by a factor of 1.5.

### 3.3 Theme 3: How should the performance of ABs be assessed?

Evaluating the performance of buildings during the design and in-use stages is critical in ensuring that we are always on track for decarbonisation. It is still an open question though what metrics must be used. This question yielded a consensus of opinion among stakeholders, as the most popular response for both groups (i.e., industry and academia) was *whole-life carbon* (Figure 4). That is, the majority of stakeholders support the use of a target for the whole-life carbon performance of buildings, with the aim of increasing potential savings in their operational and embodied carbon sides – and ultimately mitigating the climate emergency. The second most popular response was *energy demand*. Several stakeholders stated that this



**Figure 4.** The metrics for assessing the performance of Active Buildings, according to the 30 industry experts (blue) and the 30 academics and researchers (green).

metric will gain popularity over the next few years, as electricity is getting closer to its decarbonisation. They also claimed that this can be easily measured in real life and judged against predicted performance values. Other proposed metrics were *comfort*, *energy flexibility*, and *peak demand*. The latter was found to be important for three industry experts, but was not selected by any academic or researcher.

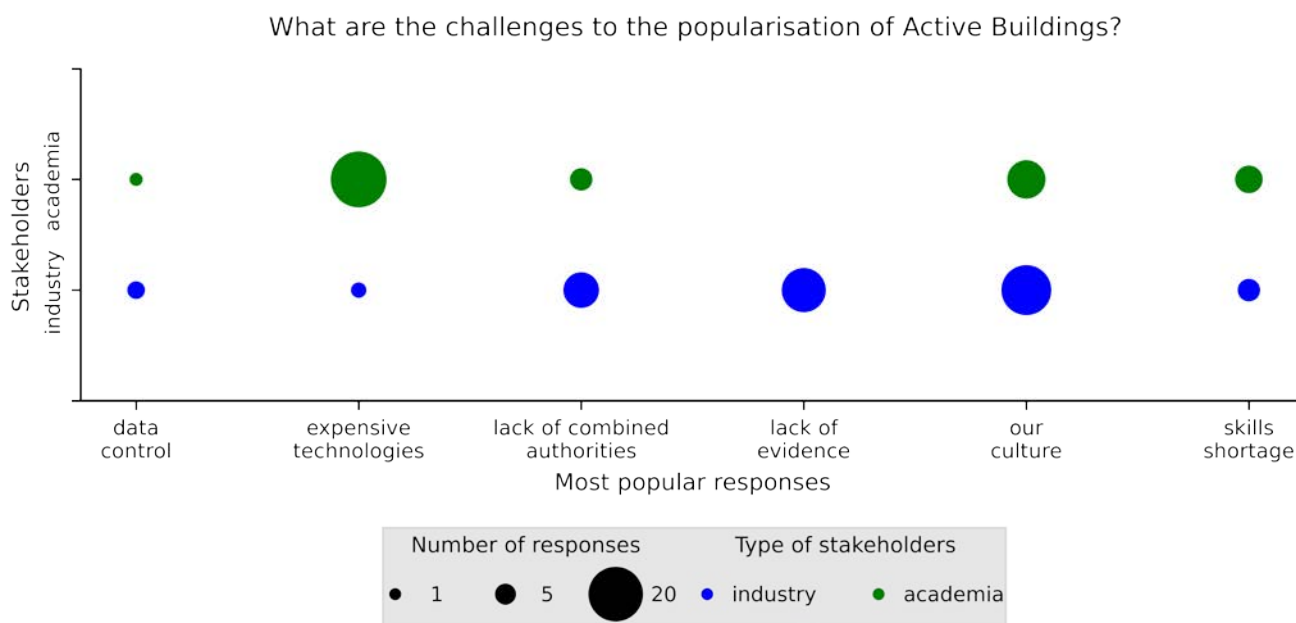
The logistic regression model verified that the two groups responded in a similar way, as there was no occasion where the interaction between options and groups was statistically significant. It also indicated that *whole-life carbon* (p-value < 0.0001) and *energy demand* (p-value = 0.02) were significantly different from *comfort*. The calculation of the odds ratios confirmed the popularity of *whole-life carbon*, and *energy demand*, followed by *energy flexibility*. That is, it showed that the odds of someone voting for them are greater than the odds of someone voting for *comfort* by a factor of 7.54, 2.7, and 1.1, respectively.

### 3.4 Theme 4: What are the challenges to the popularisation of ABs?

The industry experts also referred to the potential challenges to the popularisation of ABs (Figure 5). *Our culture* was found to be the biggest challenge, as our cultural mindset determines the acceptance – or not – of a new concept and therefore drives the market. Embedding net zero carbon in people’s mindset may prove to be challenging, as the carbon fluency of the general population is not there yet. This means that people do not automatically do things that improve the

carbon performance of buildings, but have to be nudged into doing the right thing. It is also difficult to convince people to care about the life-cycle carbon performance of buildings at the expense of capital cost. The *lack of evidence* was also considered as a main challenge. In particular, given that this is a new concept, a database of evidence has not been built yet. This is however essential for demonstrating the real-world benefits of the concept and ultimately for convincing the various stakeholders to adopt it. The *lack of combined authorities* was also found to be a challenge to the popularisation of the AB concept. It is thought that there is a lack of local connectivity, as well as a lag between planning policies and best practice – as the former often refer to a performance that barely passes the building regulations, and thus not force stakeholders to opt for greener solutions. *Expensive technologies* was only mentioned by two industry experts, but was the most popular answer for academics and researchers. This was followed by *our culture* and *skills shortage* – as there is still a shortage in terms of labour, but also of professionals with a knowledge and experience of how to deliver well-performing buildings. None of the academics or researchers voted for the *lack of evidence*.

The logistic regression model showed that options and groups interacted significantly only in the case of *expensive technologies* (p-value = 0.005). In other words, this option led to a different response pattern as it was considered as the most significant challenge by academics and researchers, but as the smallest challenge by industry experts. *Our culture* (p-value = 0.002), the *lack of evidence* (p-value = 0.007), and the *lack of combined authorities*



**Figure 5.** The potential challenges to the popularisation of Active Buildings, according to the 30 industry experts (blue) and the 30 academics and researchers (green).



(p-value = 0.04) were significantly different from *data control*, as the latter was not a popular response for either group. The calculation of the odds ratios confirmed that *our culture* is the most likely response, with the odds of someone voting for it being greater than the odds of someone voting for *data control* by a factor of 9. The latter is the least likely response, followed by *skills shortage*.

#### 4. Discussion

Section 4 discusses the stakeholder perceptions of the next generation of (active) buildings, as revealed from the focus group discussions with the industry experts, as well as from the survey of the academics and researchers.

##### 4.1 Current situation

The discussions with the industry experts revealed the immediate need to re-evaluate how we design, construct, and operate buildings – if we are to reach net zero and tackle the climate emergency. Existing building regulations and standards will have to be revised accordingly as they were found to be missing aspects that are vital for achieving decarbonisation. The aspects that were mentioned by the majority of industry experts were *performance verification* and *incentives/commitment*. That is, there is a need for a compulsory scheme for post-occupancy evaluation to ensure that buildings are truly net zero carbon in their operation. There is also a need for incentives to motivate different stakeholders to invest in low carbon solutions.

The online survey of the academics and researchers highlighted another aspect that is currently missing from regulations and standards, namely, a *whole-life perspective*. That is, a more holistic way of thinking and acting is needed in terms of minimising the CO<sub>2</sub> emissions of (new and existing) buildings. This calls for a whole-life carbon assessment to be embedded in the decision-making process. As we are gradually moving towards a better operational performance of buildings, the consideration of and reporting on embodied carbon is becoming even more crucial.

The importance of these three aspects was verified by the statistical analysis of the responses of both groups (i.e., industry and academia). These aspects were followed (in order of importance) by *pairing buildings to the energy infrastructure* and *simplicity*. Hence, to achieve decarbonisation, it is important to encourage and legislate the synergetic relationship between buildings and the grid. To ensure the wide adoption of any standard even from the early design stages, it needs to rely on a simple, well-understood formula. Finally, the revision of existing standards or the development

of new ones should account for *absolute performance targets* and *intelligence*. That is, assessing the performance of buildings in relation to notional buildings (as currently proposed by the regulations) was reported to often lead to inefficient building shapes. Absolute performance targets are hence needed to prevent designers from developing poor design solutions. Despite their important role in ensuring the optimal performance of buildings, smart building technologies were also found to be commonly neglected by regulations and standards.

##### 4.2 Going active

Aiming to cast light on the characteristics of the next generation of (active) buildings, both groups were asked to interpret ‘activeness’, without having any prior knowledge of the term. All industry experts perceived activeness as ‘responsiveness’, with the great majority of them referring to a *responsiveness to the needs of the energy infrastructure*. That is, to minimise the detrimental effect of both the building and energy sectors on the environment, buildings will have to be reactive to the needs of the grid. This agrees with the ABCode which was built around two main principles: whole-life sustainability and energy network support. Most of academics and researchers interpreted activeness as *responsiveness to internal and external conditions*. This emphasises the need to design buildings that react to changes in real time (e.g., a temperature drop), but also in the long term (e.g., a new building use). Another interpretation of the activeness was the *responsiveness to the needs of occupants*. That is, the design of buildings should include a user-centred control system that ensures the health, wellbeing, and comfort of occupants.

Another topic that arose from the discussions with the industry experts was the use of a suitable metric for assessing the performance of (active) buildings. This topic yielded a consensus, as the majority of the participants in both groups advocated the adoption of *whole-life carbon*, followed by *energy demand*, and *energy flexibility*. This also aligns with the metrics suggested by the ABCode, namely: embodied carbon, energy consumption, renewable energy production, and energy flexibility. As with the embodied carbon, energy flexibility is becoming increasingly critical in achieving decarbonisation. In more detail, achieving a stable and decarbonised grid is calling for the use of storage technologies – and hence for a metric that incentivises their use. The inclusion of *comfort* and *peak demand* in the evaluation framework for ABs was also brought to discussion. The former echoes the importance of user experience, and the latter is a reflection of the direct impact of buildings on the energy infrastructure.

### 4.3 Challenges and opportunities

The discussions also revealed the challenges to the popularisation of ABs, with the majority of industry experts regarding *our culture* as the biggest barrier. That is, according to industry experts, stakeholders tend to be driven by the capital cost of buildings. It may hence be challenging to convince them to opt for a solution that is associated with a higher capital expenditure, even if the payback period is short. The *lack of evidence* was found to be the second biggest challenge. This is also related to the way of thinking and acting of stakeholders who, in the absence of sufficient evidence, may not be convinced that it is worth adopting a new concept. The *lack of combined authorities* was also found to be a barrier, showing the catalytic role of stakeholders – and in particular of local authorities – in the wide adoption of such a new concept. In more detail, industry experts stated that there is an absence of local connectivity which detrimentally affects decision-making, as it does not encourage stakeholders to commit to building to a better standard. Interestingly, the great majority of academics and researchers considered the *high cost of technologies* as the main challenge to the adoption of the AB concept. This was mentioned by only two industry experts, with both of them stating that this is expected to change over the next years, given the rising demand for such technologies. *Skills shortage* and *data control* are also potential challenges. The former refers to the lack of experience in delivering high-performance buildings and the associated skills gap. The latter indicates the existing reticence with sharing data, which may prevent data management from reaching its full potential.

In addition to drawing attention to the barriers the wide adoption of the AB concept may possibly face, the discussions with the industry experts indicated future opportunities. In other words, they revealed approaches and technologies that are expected to be gaining popularity on our way to decarbonisation – and that should thus be further expanded in future iterations of the ABCode. Focusing on social aspects, there is an increasing demand for healthy buildings, which was accelerated due to COVID-19. The ability of ABs to boost the *health, wellbeing, and comfort* of their occupants, should hence be further promoted. The applicability of the AB concept to a community of buildings should also be underlined as, in addition to any environmental and financial benefits, it offers a sense of *collectiveness* that adds value to the user experience. The growing interest in *circular economy* is another opportunity that should be henceforth harnessed by the ABCode, which already encourages

users to consider the life-cycle environmental effect of buildings. Regarding any technical aspects, the ability of ABs to provide energy flexibility should be expanded by harnessing emerging technologies e.g., *smart technologies, storage systems, electric vehicles, and digital twin*.

## 5. Conclusions

As countries declare a climate emergency one after another, setting targets and timelines for net zero carbon is becoming crucial. The building sector is a major contributor to carbon dioxide emissions, and hence a vital player in addressing the climate crisis. Nevertheless, building regulations and standards are failing to promote holistic solutions, hence seriously lagging behind the trajectory needed to achieve net zero. Despite the direct link between buildings and the grid, regulations and standards lack a synergistic way of thinking and acting. This is certainly a missed opportunity for the decarbonisation of both sectors. In this context, we recently introduced the Active Building Code (ABCode) [10]. This is a new building standard that promotes the synergetic relationship between the electrical grid and the next generation of buildings termed Active Buildings (ABs), in order to help both the energy and building sectors reach net zero.

This paper presented the stakeholder perceptions of ABs, as arose from the focus group discussions with 30 industry experts and the survey of 30 academics and researchers. Existing regulations and standards were found to be missing valuable aspects, namely (in an order of importance, as defined by the two groups of stakeholders): *performance verification, incentives and commitment, whole-life perspective, pairing buildings to energy infrastructure, simplicity, absolute performance targets, and intelligence*. The need to pair buildings to the energy infrastructure was also revealed by the definition of an AB, as provided by the majority of industry experts. That is, an AB is a building that is *responsive to the needs of the energy infrastructure*, being in line with the definition included in the ABCode. Academics and researchers interpreted activeness as *responsiveness to internal and external conditions* or *responsiveness to the needs of occupants*, hence further highlighting the need for adaptive buildings. With respect to the metric(s) for assessing the performance of ABs, both groups of stakeholders stated that *whole-life carbon, energy demand, and energy flexibility* should be the way forward. This again aligns with the metrics that are proposed in the ABCode. The inclusion of *comfort* and of *peak demand* was also brought to discussion. Finally, the barriers that must be removed to drive

the scale-up of ABs were also revealed: *our culture, lack of evidence, lack of combined authorities, high cost of technologies, skills shortage, and data control.*

To conclude, the (visual and statistical) analysis of responses revealed the aspects that are more likely to be voted for by any stakeholder – and that should be prioritised when designing the next generation of buildings. No significant statistical differences were in general observed between the responses from the two groups of stakeholders. In the future, additional responses should be collected to increase statistical power, and hence draw safer conclusions about the response patterns of different stakeholders. Future research should also build on the opportunities that arose from the focus group discussions. These may cover both social and technical aspects, in order to further improve the carbon performance of ABs and ensure these are delivering the best user experience. The stakeholder perceptions that were expressed in this study could be useful in writing regulations and standards that not only drive down carbon, but are also widely comprehended and accepted.

## Acknowledgement

This study was conducted in the context of the Active Building Centre Research Programme (EP/V012053 /1). The programme brings together several leading universities, businesses, as well as service providers to develop innovative ideas and technologies which will enable the construction industry to transform into a net zero emissions sector. It is funded through the UKRI Transforming Construction Challenge.

We would like to warmly thank each industry expert who participated in the focus group discussions, and each academic or researcher who participated in the survey for their valuable input. We would also like to thank Dr Emma Cliffe for her valuable advice on the statistical analysis of the collected data.

## Data access statement

The data that was collected and analysed during this study is available at the University of Bath Research Data Archive [17]. ■

## References

- [1] Hoegh-Guldberg O, Jacob D, Taylor M, Bindi M, Brown S, Camilloni I, et al. Impacts of 1.5°C of global warming on natural and human systems. World Meteorological Organization. 2018.
- [2] National Grid. What is net zero? [Internet]. 2021 [cited 2022 Jan 13]. Available from: <https://www.nationalgrid.com/stories/energy-explained/what-is-net-zero>.
- [3] UK Government. The Climate Change Act 2008 (2050 Target Amendment) Order 2019. 2019.
- [4] European Commission. Clean energy for all Europeans. 2019.
- [5] LETI. Climate Emergency Design Guide. 2020.
- [6] Nikolaidou E, Fosas D, Roberts M, Allen S, Walker I, Coley D. Buildings as energy infrastructure, not passive consumers. Active Building Centre Research Programme (University of Bath). 2020.
- [7] National Grid. Flexibility [Internet]. 2021 [cited 2022 Jan 13]. Available from: <https://www.nationalgrideso.com/future-energy/future-energy-scenarios/fes-2021/system-flexibility>.
- [8] Active Building Centre Research Programme. The Active Building concept [Internet]. 2022. [cited 2022 Jan 10]. Available from: <https://abc-rp.com/about-us/>.
- [9] Bankovskis A. One million homes constructed as “buildings as power stations”. SPECIFIC Innovation and Knowledge Centre; 2017.
- [10] Fosas D, Nikolaidou E, Roberts M, Allen S, Walker I, Coley D. Towards active buildings: Rating grid-servicing buildings. Build Serv Eng Res Technol. 2021;42(2):129–55.
- [11] Kontio J, Bragge J, Lehtola L. The focus group method as an empirical tool in software engineering. In: Guide to advanced empirical software engineering. London: Springer; 2008. p. 93–116.
- [12] Kamberelis G, Dimitriadis G. Focus groups: Contingent articulations of pedagogy, politics, and inquiry. In: Collecting and interpreting qualitative materials. Los Angeles: SAGE Publications; 2008.
- [13] Stewart DW, Shamdasani P. Online focus groups. J Advert. 2017;46(1):48–60.
- [14] Patton MQ. Qualitative research. In: Encyclopedia of Statistics in Behavioral Science. Chippinham: John Wiley and Sons; 2005.
- [15] Glaser BG, Strauss AL. The discovery of grounded theory: Strategies for qualitative research. New Brunswick: Aldine Transaction; 1967.
- [16] Finch H, Lewis J, Turley C. Focus groups. In: Ritchie J, Lewis J, McNaughton Nicholls C, Ormston R, editors. Qualitative research practice: A guide for social science students and researchers. London: SAGE Publications; 2013.
- [17] Nikolaidou E, Walker I, Coley D, Allen S, Fosas D. Dataset for “Going active: How do people envision the next generation of buildings?”. University of Bath Research Data Archive; 2022. Available from: <https://doi.org/10.15125/BATH-01125>.

# 5-year performance of a Swedish mixed-use ground source heat pump system



**JEFFREY D. SPITLER**  
School of Mechanical and  
Aerospace Engineering,  
Oklahoma State University,  
Stillwater, Oklahoma  
spitler@okstate.edu



**SIGNHILD E. A. GEHLIN**  
The Swedish Geocenter,  
Lund, Sweden  
signhild.gehlin@geoenergicentrum.se

**Keywords:** GSHP, system performance, monitoring, SPF, Annex 52

## Abstract

The thoroughly instrumented 200 kW ground-source heat pump system serving 6300 m<sup>2</sup> two-story Studenthuset building in Stockholm, has now been monitored for five years. 20 boreholes of 200 m depth in hard rock serve as the source for the heat pumps and also provide space cooling directly. This paper presents the results in the form of a range of performance indicators that describe the short-term and long-term system performance. Performance factors are computed for several boundaries defined by the IEA HPT Annex 52 boundary schema. Seasonal, monthly, daily, and binned performance factors for both heating and cooling operation are presented and discussed.

## 1. Introduction

The energy consumption of building heating and cooling systems often exceeds design expectations, the so-called “building energy performance gap.” [1] Reasons for the gap include errors in design and installation, and non-optimal operating and control settings. Problems that don't lead to occupant discomfort may neither be detected nor mitigated for months or years without performance measurements. Despite the need for measurements, published results from long-term performance monitoring of building energy systems are scarce.

For larger non-residential ground-source heat pump (GSHP) systems, measured performance is seldom reported. Spitler and Gehlin [2] give an overview of published long-term (> 1 year) measured SPF and COP values reported in the literature for 55 systems worldwide. Such systems are necessarily more complex than GSHP systems for small residential buildings, and often include both heating and cooling as well as supplementary heating and cooling sources and heat recovery.

In 2018 a four-year international collaboration project IEA HPT Annex 52, *Long-term performance measurement of GSHP systems for commercial, institutional and multi-family buildings* [3] began with the aim to monitor and analyze the long-term performance of a large number of GSHP systems in several countries. The emphasis was on heat pump and system performance, e.g. determining coefficients of performance, seasonal performance factors and other system efficiency indicators. The project closed at the end of 2021, with performance measurement results from 30 large GSHP systems in seven countries. The Annex has yielded a number of case study reports as well as guidelines for instrumentation [4] and uncertainty analysis [5].

One of the monitoring projects within IEA HPT Annex 52 is the GSHP system at the student union building “Studenthuset” at Stockholm University in



Sweden. Spitler and Gehlin [2] analysed performance data for one year of operation (April 2016-March 2017) including seasonal performance factors and monthly, daily, and binned average values of coefficients of performance, as well as a detailed uncertainty analysis. Spitler and Gehlin [6] present an extended analysis of performance data from Studenthuset, including three years of analysed data and a discussion about the correlation between performance factors and heating and cooling load. The authors conclude that the system performance is strongly related to the load. With increasing load, the system performance also increases, and the system has relatively poor performance at times when the heating and cooling loads are low.

In this paper, a streamlined version of [7], an extended analysis of 60 months of monitoring (2016 - 2020) from the Studenthuset GSHP system is presented. Performance factors for multiple system boundaries and time frames as well as additional performance indicators and their correlation to load are analysed and discussed. The datasets generated and analyzed during the current study are available at: <https://doi.org/10.22488/okstate.22.000005>.

## 2. Studenthuset GSHP system

The Studenthuset building is a 6300 m<sup>2</sup> four-story building completed in the fall of 2013. It contains office area, meeting rooms, study-booths for students and a café. The building services are thoroughly instrumented and maintained by highly skilled staff. The building services and GSHP system are described in references [2,6,7].

The building's heating, cooling and domestic hot water (DHW) loads are met by the GSHP system. No auxiliary heating or cooling is installed, except for an electric resistance heater that boosts the hot water temperature to protect against Legionella. Heat distribution is provided by radiators with extra-large surface areas at a distribution temperature of 40°C instead of 55°C, which is the more common distribution temperature in Sweden. The cooling distribution system is a combination of VAV (variable air volume) and CAV (constant air volume) with chilled beams for ventilation and cooling.



**Figure 1.** Studenthuset in Stockholm, Photo: JD Spitler.

Space heating and DHW are provided by the GSHP system which consists of five 40 kW off-the-shelf water-to-water heat pumps connected to a borehole field with 20 groundwater-filled boreholes in hard rock. The boreholes are 200 m deep and are fitted with single u-tubes filled with an ethanol/water mixture. The bore field is located below a landscaped courtyard and the boreholes are drilled at an angle so that they reach under the surrounding building. Space cooling is provided by direct cooling from the boreholes.

### 2.1 System schematic and boundaries

**Figure 2** shows a simplified schematic layout of the Studenthuset GSHP system. Six levels of system boundaries (0-5) are defined in the figure, for the evaluation of performance indicators.

The six system boundary levels were developed within the IEA HPT Annex 52 project and represent an extension of the widely used system boundary schema developed within the EU project SEPEMO [8] in 2012. While the SEPEMO boundary schema was aimed at small monovalent or bivalent heat pump systems, the Annex 52 schema allows for a higher degree of system complexity such as in larger GSHP systems like Studenthuset. The Annex 52 system boundary schema with six boundary levels and an indicator for use of supplemental heating or cooling is one of the outcomes from the IEA HPT Annex 52 project and is described in more detail in [9]. It is used in this paper and [6,7] for the analysis of the Studenthuset operation and performance, while the SEPEMO schema was used in [2].

The measured data for Studenthuset allows for calculation of heating performance at boundary levels H2, H3+ and H5+\* and cooling performance at boundary levels C2 and C3 (which are the same for this system).

Performance factors may also be estimated for boundary levels H1\* and C5\*, with some approximations; the asterisk is used to indicate that the measured performance factor does not exactly correspond [7] to the Annex 52 definition.

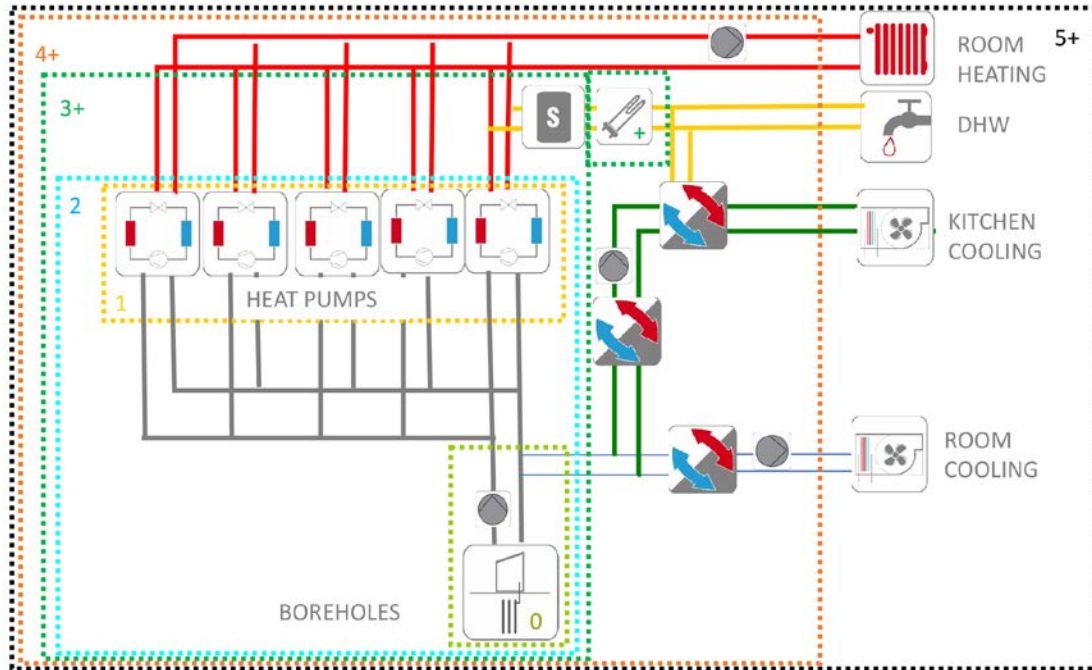
### 2.2 Instrumentation and uncertainty analysis

Full descriptions of the instrumentation and uncertainty analysis are given in [2]; error bars shown in this paper are based on that analysis. While most measurements are made with individual meters, the electricity use for the five heat pumps and the electricity consumed by the Legionella protection system are measured by one electricity meter. Therefore, the energy consumed by the Legionella protection system (LPS) is estimated from other measurements and subtracted.

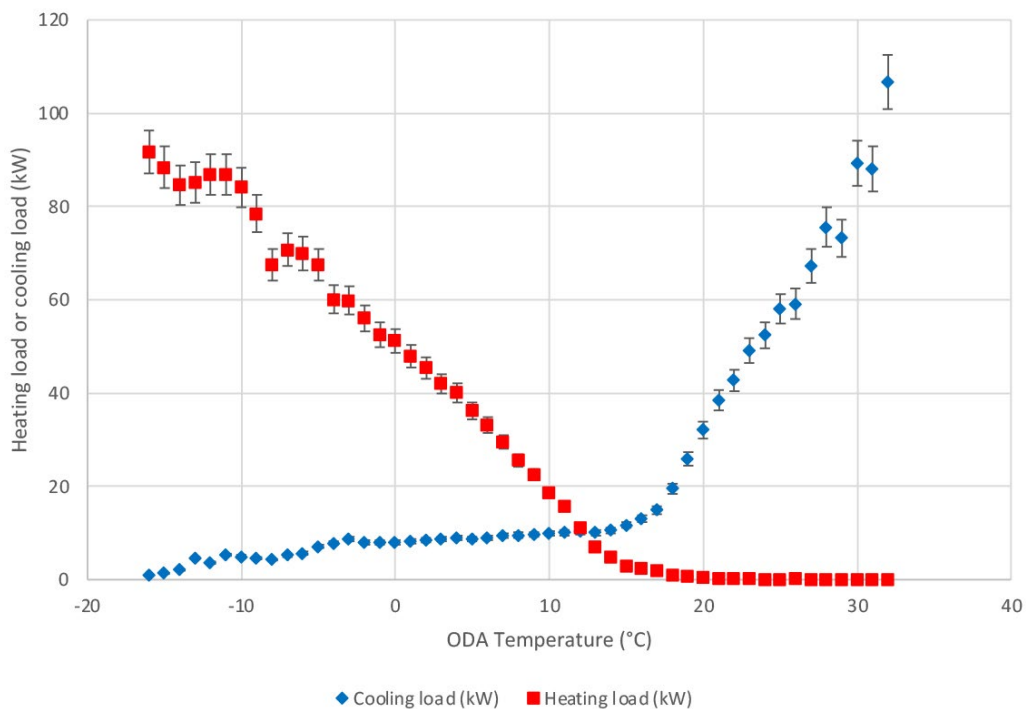
### 3. Energy loads

A common way to characterize the building space heating and cooling loads is the energy signature,

shown in **Figure 3** for Studenthuset. This signature excludes domestic hot water heating and kitchen refrigeration. The building uses a modest amount of



**Figure 2.** Schematic and Annex 52 system boundaries for Studenthuset. Pictograms in drawing used with permission from TU Braunschweig IGS.



**Figure 3.** Energy signature: building heating & cooling.

cooling even down to low outdoor air temperatures. Presumably, this is due to chilled water being circulated and casually gaining heat from the space.

### 3.1 Annual balance

For ground-source heat pump systems, the balance between annual heat rejection and heat extraction is an important parameter. A detailed analysis [7] gives the estimates of the annual loads on the ground shown in **Figure 4**, with positive values representing heat extraction and negative values representing heat rejection or reductions in heat extraction. If the annual heat transfer were perfectly balanced, the positive and negative portions in **Figure 4** would have the same magnitude. It is notable that the load-side circulating pumps and fans (LSCPF) consume more energy than the heat pump compressors, while the source side circulation pumps (SSCP) use a very small amount of energy. The net effect is that, even though the building heating loads are higher than the building cooling loads, the system rejects about 30% more heat than it extracts.

### 3.2 Ground heat exchanger performance

Ground-source heat pump systems usually have more favorable source temperatures than air-source heat pump systems. **Figure 5** illustrates this, showing both the hourly outdoor air temperature and hourly exiting

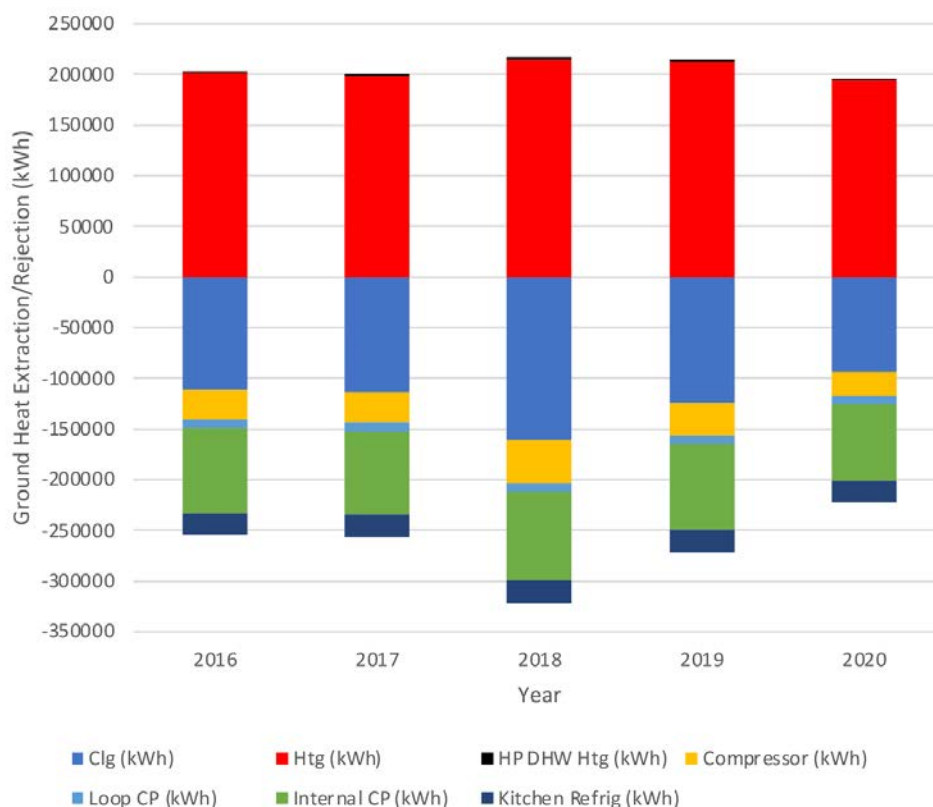
fluid temperature from the GHE. Although it is not clearly seen in the plot, there is a very slight (0.2°C) rise in the GHE temperatures over the five-year period of operation. This is consistent with the annual heat rejection being higher than the annual heat extraction.

The cooling system was designed to operate with a maximum temperature of 16°C coming back from the boreholes. To date, the highest return temperature was 14.1°C during the unusually hot summer of 2018. This suggests that the system will likely operate for many years before peak temperatures hit 16°C. That is, there is plenty of time to adjust system operation to mitigate this slight temperature rise.

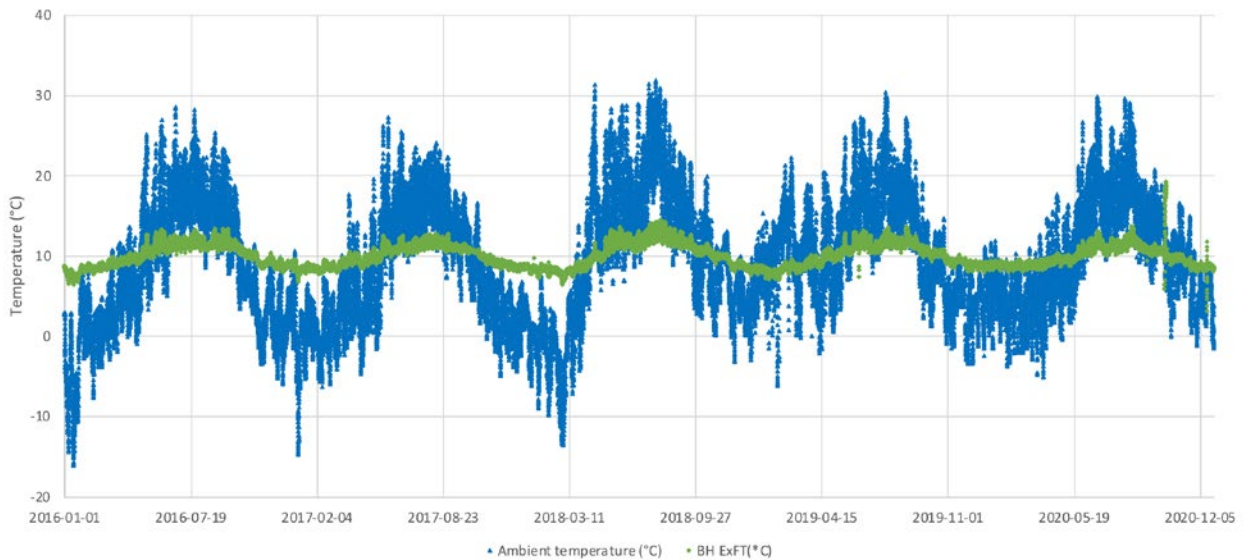
## 4. Results

### 4.1 Energy consumption

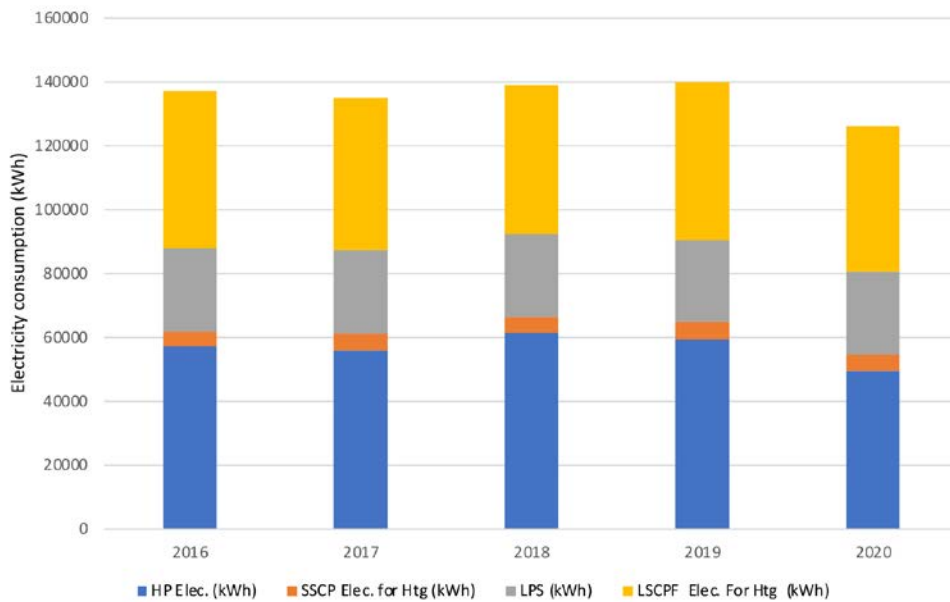
The electrical energy consumption for each of the measured five years is summarized for heating (**Figure 6**) and cooling (**Figure 7**). The electrical energy for the load-side circulating pumps and fans (LSCPF) and the source-side circulating pump (SSCP) are allocated proportionally to the amount of heating and cooling provided. It's notable that the energy used for distributing heating (LSCPF) is similar to that used by the heat pumps for heating. This has a deleterious impact on the system performance.



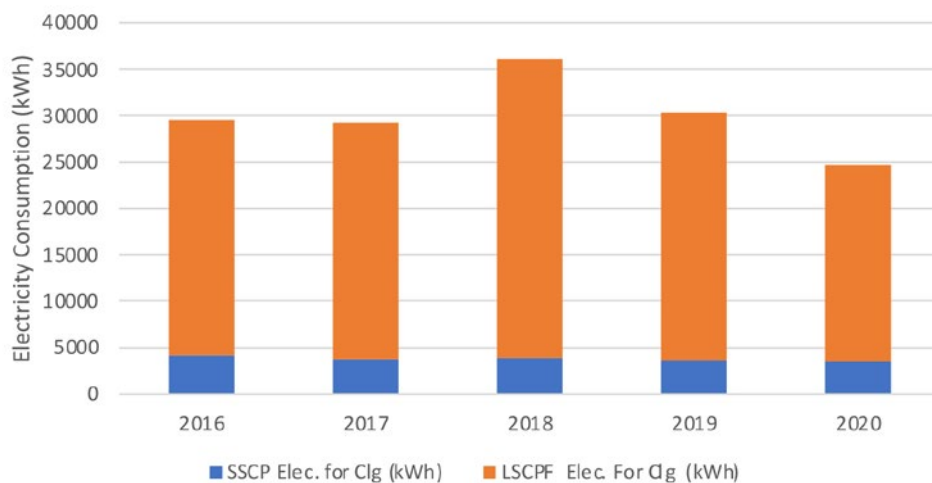
**Figure 4.** Estimated energy rejection and extraction components (to/from ground).



**Figure 5.** Ground heat exchanger entering fluid temperature and ambient temperature over the five years of measurement (2016-2020).



**Figure 6.** 5-year electricity use breakdown for heating.



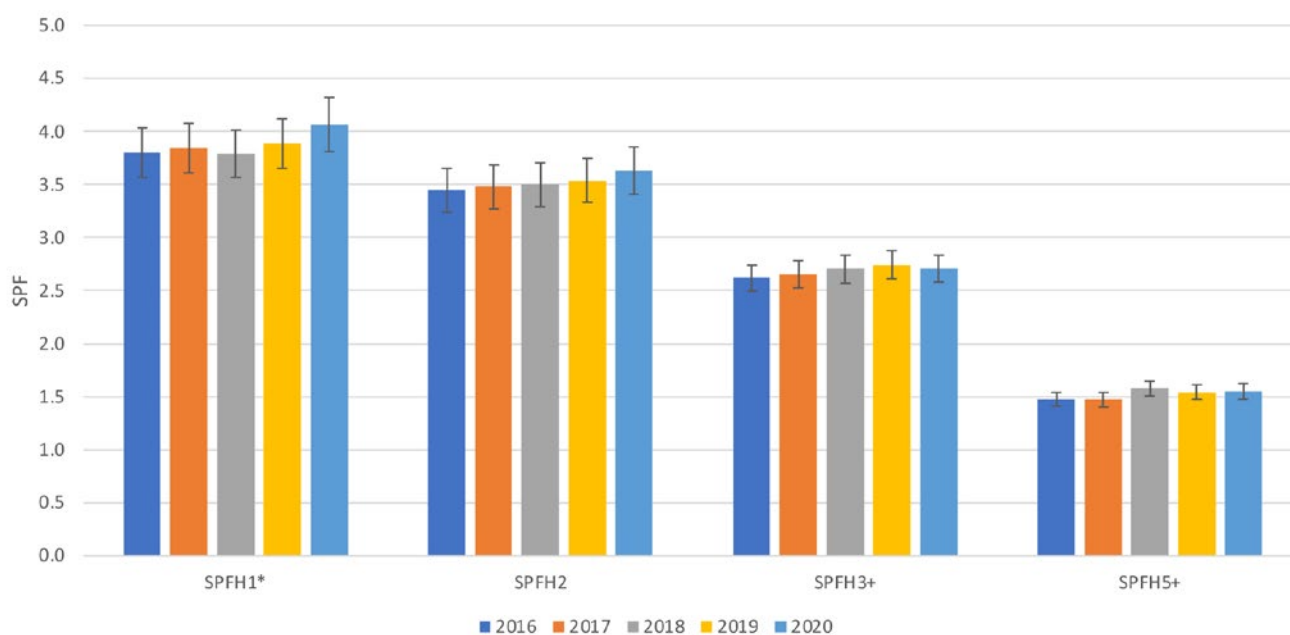
**Figure 7.** 5-year electricity use breakdown – cooling.



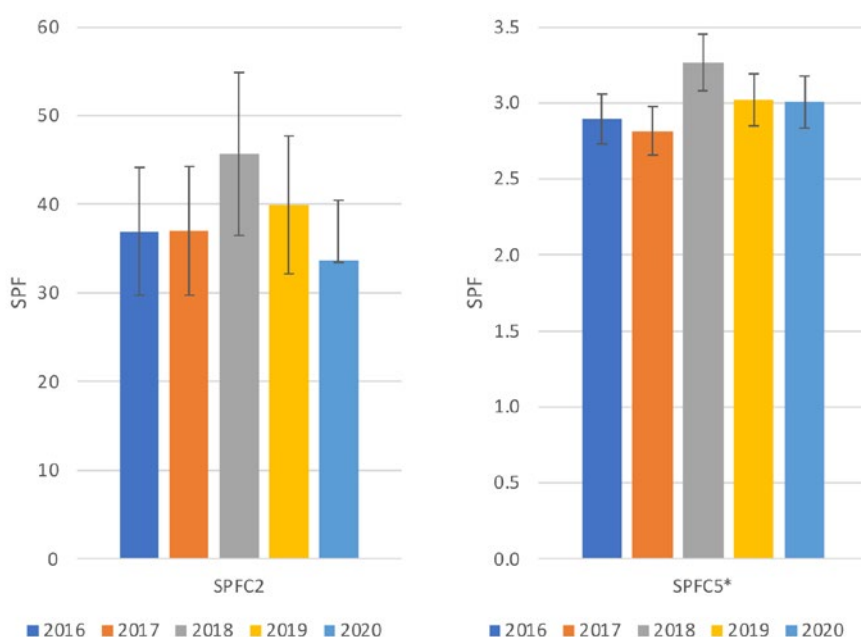
#### 4.2 Seasonal Performance

Seasonal performance factors for heating are computed for each year, grouped by the Annex 52 boundaries defined in **Figure 2**, with deviations indicated with asterisks as discussed in Section 2. For each boundary, minor year-to-year fluctuations can be observed. From boundary 1\* to 2, the SPF decreases due to the source-side circulating pump (SSCP). A further drop from boundary 2 to boundary 3+ is caused by the Legionella protection system (LPS), which consists of electric resistance heating to raise the hot water temperature

to 60°C from the 55°C water provided by the heat pumps, and recirculation pumps that maintain high water temperatures throughout the piping network. Finally, from boundary 3+ to 5+\*, the load-side circulation pumps and fans consume more electrical energy than the heat pump compressors and consequently reduce the seasonal performance factor (SPF) by more than 40% to approximately 1.5. The design and operation of the load-side pumping and piping was not part of our study, but it seems likely that there is significant room for improvement.



**Figure 8.** Heating SPF (2016-2020).



**Figure 9.** Cooling SPF (2016-2020).

SPFs for the cooling system are given in **Figure 10** for boundaries 2 and 5\*. (Note difference in scale.) Boundary 2 shows very high SPF values, as the only electrical energy is for the source-side circulating pump. However, when accounting for the load-side circulating pumps and fans, with boundary 5\*, the system performance is not so great. Meaningful comparisons can be difficult to make, but [10] reports cooling SPFC5 (including fan energy) of a distributed GSHP system with much higher ground temperatures of  $4.2\pm 0.6$ . The distributed GSHP system did not have “free cooling” yet was able to provide cooling to the space significantly more efficiently than the Studenthuset system.

The performance factors shown above rely on allocation of the energy consumed by circulating pumps and fans between cooling and heating. An alternative approach is to calculate an overall performance factor for heating and cooling. The impact of the internal heating and cooling distribution energy is still substantial, decreasing the 5-year SPF from  $5.2\pm 0.2$  at boundary HC2 to  $1.8\pm 0.3$  at boundary HC5+\*.

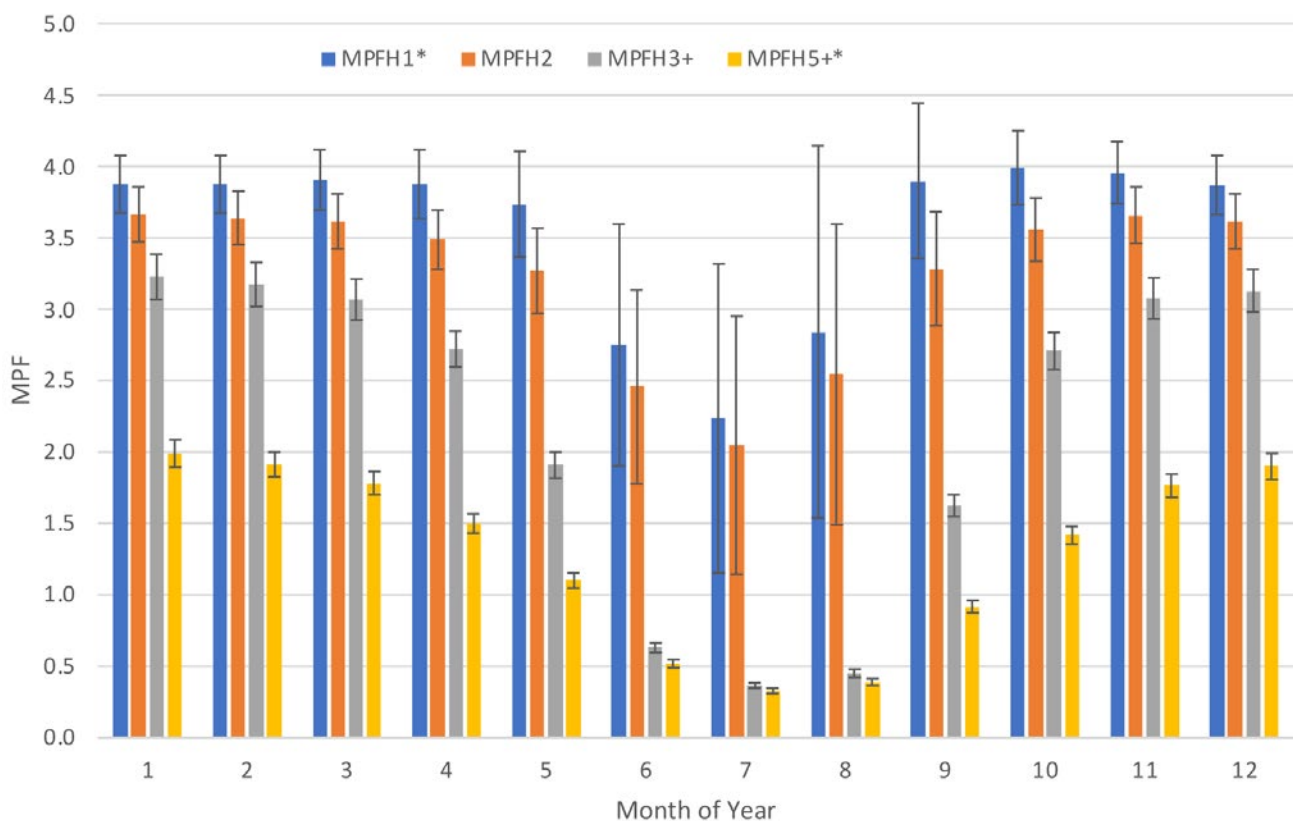
#### 4.3 Monthly Heating and Cooling Performance

Monthly performance factors (MPF) for heating and cooling are shown in **Figure 10 and 11**, respectively. Perhaps contrary to thermodynamic expectations, heating MPF are higher in the winter and lower in the summer, when the ground heat exchanger return temperatures are more favorable. As previously observed for this system and other systems – parasitic losses (e.g. control boards and energized solenoid valves) and cycling losses decrease the performance of GSHP under low-load conditions.

For cooling, MPF are higher during the winter months, when return fluid temperatures from the ground are lower. This is as expected, but the trend is also due to the allocation of pumping energy between heating and cooling, as will be shown in the next section.

#### 4.4 Effect of source temperature

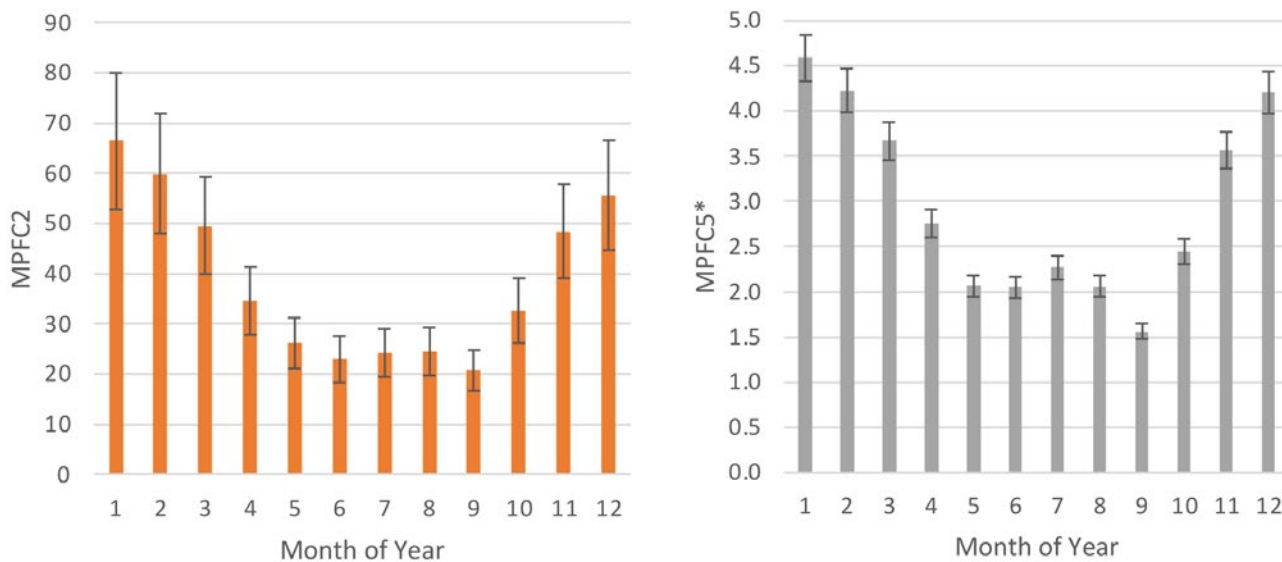
From a thermodynamic perspective, heat pump performance is expected to increase as source temperatures become more favorable. Binned performance factors have been calculated for heating and cooling,



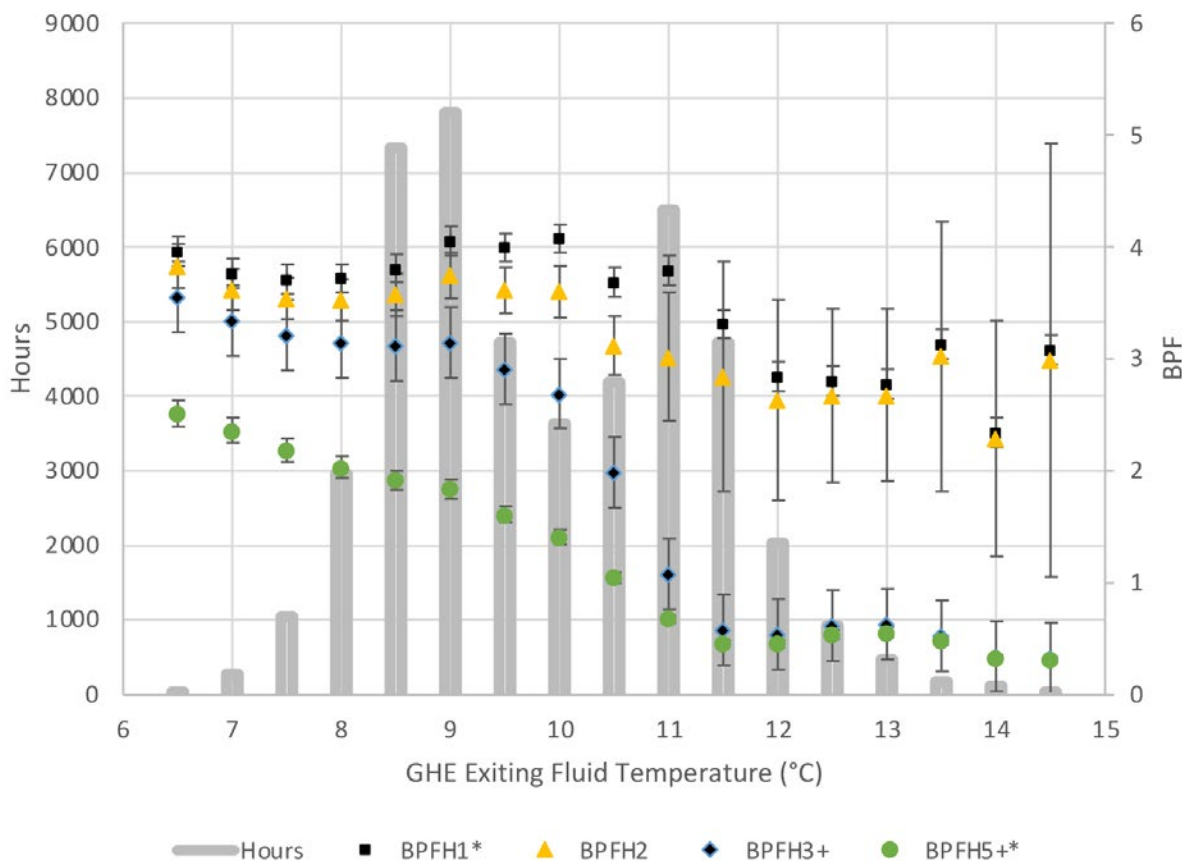
**Figure 10.** Heating monthly PF (2016-2020).

as shown in **Figures 13 and 14**. Each symbol or bar in these figures represents performance for all hours in a certain bin. E.g., the symbol at a GHE exiting

fluid temperature of 8°C represents all hours with temperatures between 7.75 and 8.25°C. The gray bars represent the number of hours in each bin.



**Figure 11.** Binned monthly performance factors for cooling for each month in 2016-2020, with error bars.



**Figure 12.** Binned performance factors for heating vs ground heat exchanger exiting fluid temperature.

Opposite to thermodynamic expectations for heating with heat pumps, the performance for every boundary trends downward with increasing entering fluid

temperature to the heat pump. The highest GHE ExFT occur in the summer period, which is a period with low use of Studenthuset and when the need for

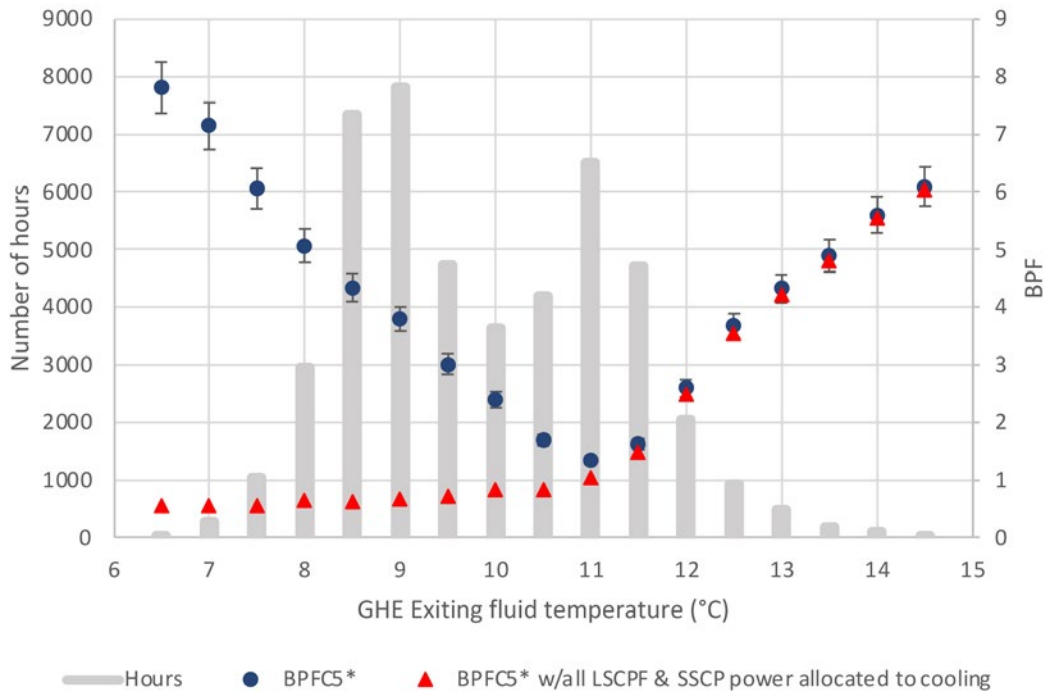


Figure 13. Binned performance factors for cooling vs ground heat exchanger exiting fluid temperature.

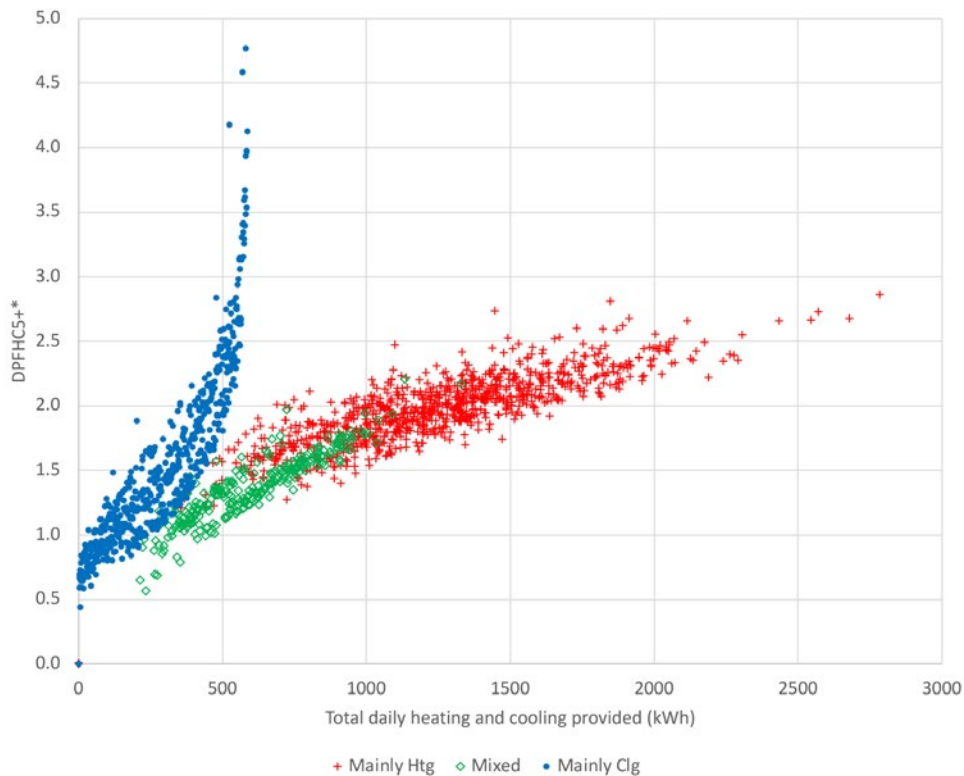


Figure 14. Binned daily total performance factors vs total heating and cooling provided at boundary 5+\*.



heating is mainly for DHW and Legionella protection. Energy use for circulation pumps and LPS will then be high compared to delivered energy, hence the low performance factors.

For cooling, the performance factors show a V-shaped trend – highest at low or high temperatures, lowest at the middle point. For space reasons, only boundary 5\* is shown here, but the trend is the same for boundary 2. At low temperatures, where cooling is being provided simultaneously with heating, the amount of pump energy allocated to cooling is small, leading to high BPF. This is shown by calculating the BPF assuming that all of the pump and fan energy is allocated to cooling – shown as the orange triangles in **Figure 13**. In this case the performance increases with increasing fluid temperature. This is also contrary to expectations – for any given amount of pump and fan energy, one would expect to see a decrease in performance factor for cooling, as the GHE ExFT increases. However, the temperatures are highest during periods of high loads, which is also when the amount of energy used for circulation pumps and fans are lowest compared to delivered cooling.

#### 4.5 Effect of total heating and cooling

As may be inferred from the above results, the amount of heating and cooling being provided has a significant impact on the overall system performance, reducing the proportion of electrical energy used for pumping, blowing, and “parasitic” uses like control boards and solenoid valves.

**Figure 14** shows binned daily system performance factors (boundary HC5+\*) for heating and cooling combined, vs. the total amount of heating and cooling being provided. The performance factors are divided into days that are “mainly cooling”, “mixed”, and “mainly heating”, based on the ratio of heating provided to total heating and cooling providing being less than 0.25, between 0.25 and 0.67, and greater than 0.67, respectively. The general trend for all categories is increasing performance with increasing total load. The mainly cooling days give relatively high performance as the better performance of the free cooling system becomes dominant with higher loads. The character of the “mixed” days follows the trend of the “mainly heating” days, although in the lower load and performance factor region.

## 5. Conclusions

In this paper, five years of data from the Studenthuset ground-source heat pump system have been analyzed from a system performance perspective. The measured data for the period 2016-2020 show that the ground

heat rejection exceeds the ground heat extraction by about 30%, leading to a minimal temperature increase over the five measured years. The analysis indicates that if operated as is, the GHE will not exceed its temperature constraints for many decades.

The dominant factor for the overall system performance is the amount of heating and cooling provided by the GSHP system – increased heating and cooling leads to higher PF. The reason is that the proportion of electrical energy used for circulation pumps, fans and “parasitic” uses such as control boards and solenoid valves decrease when energy provided increases. The Studenthuset GSHP PF are highest when the building is used heavily, and the lowest performance factors appear during those periods when students are off campus and the building is little used. During those periods standby circulation, DHW and Legionella protection are dominant.

The Studenthuset study pinpoints the deleterious effect of the load side distribution (piping, pumping, fans) and LPS on the system performance factors. The distribution system and Legionella protection systems result in the 5-year combined heating and cooling SPF decreasing from 5.2 at boundary HC2 to 1.8 at boundary HC5+\*. While it is important to maintain proper Legionella protection, the LPS operation ought to be optimized so that it does not use more energy than necessary. There is room for further system improvement and component development to minimize the energy use for load side distribution. Comparisons to a distributed GSHP system [10] in the USA suggest that the load-side system distribution energy in Studenthuset is excessive. Comparative studies between centralized and distributed GSHP systems would be useful in shedding further light on distribution energy in heat pump systems.

## 6. Acknowledgements

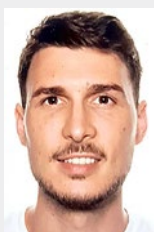
Thanks go to Anders Larsson and Akademiska Hus providing measurement data and information about the monitored building, along with permission to make the data publicly accessible. The support from the authors’ employers and the Swedish Energy Agency (TERMO research program Grant 45979-1) is gratefully acknowledged. This work is part of the IEA HPT Annex 52. [3].

## References

Please find the complete list of references in the htm-version at <https://www.rehva.eu/rehva-journal> ■

Copyright ©2022 by the authors. This conference paper is published under a CC-BY-4.0 license.

# Design of highly compact indirect evaporative coolers



**FRANCISCO COMINO**

Departamento de Mecánica, Escuela Politécnica Superior, Universidad de Córdoba, España  
francisco.comino@uco.es



**JESÚS CASTILLO-GONZÁLEZ**

Centro Tecnológico del Plástico Andaltec, Jaén, España



**FRANCISCO J. NAVAS-MARTOS**

Centro Tecnológico del Plástico Andaltec, Jaén, España



**PABLO E. ROMERO**

Departamento de Mecánica, Escuela Politécnica Superior, Universidad de Córdoba, España,



**MANUEL RUIZ DE ADANA**

Departamento de Química-Física y Termodinámica Aplicada, Escuela Politécnica Superior, Universidad de Córdoba, España

**Keywords:** air-cooling system, heat and mass exchanger, evaporative cooler, cooling capacity, manufacturing. DOI: <https://doi.org/10.34641/clima.2022.182>

## Abstract

Evaporative cooling units are an effective alternative to conventional air conditioning technologies, due to their high efficiency and reduced primary energy consumption. There are two main types of evaporative cooling systems: the direct evaporative cooling (DEC) system, and the indirect evaporative cooling (IEC) system. DEC is based on direct contact between air and water, while IEC is based on heat and mass transfer between two flows of air, separated by a heat transfer surface with a dry side, where only air is cooled, and a wet side, where water is evaporated into air. The main objective of the present work was to design and manufacture a highly compact indirect evaporative cooler. Firstly, a mathematical model based on  $\epsilon$ -NTU numerical method to determine the optimal geometrical and operating parameters of an IEC system was developed. The mathematical model allowed to obtain the temperature, enthalpy and humidity distributions of the air inside the exchanger. Then, the air-cooling system was manufactured. The device consisted of a compact

heat and mass exchanger, a water distributing system and an outer casing. Finally, the IEC system was studied experimentally. An experimental facility was designed to study these air-cooling systems. The cooling unit performance indicators were the cooling capacity per unit volume and per unit airflow rate. The experimental results showed that the cooling capacity per unit volume of the device was  $177 \text{ kW/m}^3$ , and the cooling capacity per unit airflow rate was  $10.9 \text{ kW}/(\text{m}^3/\text{s})$ . These results suggested that highly compact indirect evaporative coolers can achieve air-cooling processes with a low energy consumption and a low environmental impact.

## 1. Introduction

European Union directives reinforced the objective of reducing primary energy consumption and the integration of renewable energies in buildings, instead of using fossil fuels [1]. A large percentage of current energy consumption and  $\text{CO}_2$  emissions are due to heating, ventilating and air conditioning, HVAC, systems.

A traditional method widely used in air cooling is that of conventional HVAC systems based on direct expansion units [2]. However, direct expansion systems typically use refrigerant gases, which could emit polluting gases into the atmosphere, and in addition, they depend mainly on electrical energy.

Another air-cooling technology is evaporative cooling. The evaporative cooling units are based on heat and mass transfer between air and cool water [3]. There are two main types of evaporative cooling systems: the direct evaporative cooling, DEC, system and the indirect evaporative cooling, IEC, system. DEC is based on direct contact between air and water, while IEC is based on heat and mass transfer between two flows of air, separated by a heat transfer surface with a dry side, where only air is cooling, and a wet side, where water is evaporated into air [4]. In addition, there are different types of IEC [4]: conventional IEC, which supply air between the dry bulb temperature and the wet bulb temperature; dew-point evaporative cooler (DIEC), including single-stage counter-flow, and finally, Maisotsenko-cycle (MIEC), including multi-stage cross-flow. The last two supply air between the dry bulb temperature and the dew point temperature.

One of the most effective indirect evaporative cooling solutions are the dew-point counter-flow cycles, DIEC, [5]. The DIEC systems have been studied for many applications [6]. A DIEC with a direct expansion system applied to a residential building in China showed high potential for energy savings [7], up to 39% compared to a direct expansion system. DIEC systems were combined with desiccant systems [8–10], managing to control temperature and humidity independently.

IEC systems have been widely analysed by many authors in the available literature [11,12], in particular focusing on the analysis of influential parameters on outlet air conditions, such as inlet air temperature, inlet air humidity. The coefficient of performance of IEC systems was analysed for different operating conditions, evaluating the effect of variable inlet air velocities [13]. The amount of water flow rate was also analysed [14], which has a significant effect on system performance. The influence of the exchanger material was studied in other works [15].

The design of IEC systems was also analysed in recent works to improve their thermal behaviour. The cooling power of a DIEC system with different number of perforations between the dry and wet

channels was analysed [16]. The results showed that the configuration with a single air passage increased the cooling power compared to configurations with four air passages. In another work, a mathematical model of DIEC was developed with different numbers of air passages. [17]. Two DIEC systems with cross flow configuration, one with fins and one without fins, were developed and analysed under different inlet air conditions [18]. The DIEC system with fins improved thermal performance up to 40% compared to the same system without fins. An optimization study of a DIEC unit with counter-flow configuration was developed [19]. The goal of the study was to increase the performance of the system by varying the air speed, the flow rate and the length and height of the channels. A DIEC with counter-flow configuration was manufactured from the results obtained of an optimal design with a mathematical model [20]. The energy performance of this system increased up to 19%.

Therefore, managing air with an efficient air-cooling unit, such as IEC systems, which does not depend mainly on electrical energy and does not use any refrigerant, could be an interesting alternative to conventional air-cooling units based on vapor-compression cycles. The main advantages of evaporative coolers are their constructive simplicity and high efficiency.

The main objective of the present work was to design and manufacture a highly compact indirect evaporative cooler. The cooling unit performance indicators were the cooling capacity per unit volume and per unit airflow rate. Firstly, a mathematical model based on modified  $\varepsilon$ -NTU numerical method to determine the operating parameters and optimal geometrical of an IEC was developed. Then, the air-cooling system was manufactured.

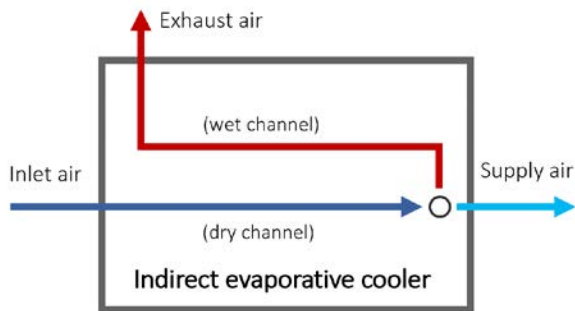
## 2. Materials and methods

The steps followed to develop the IEC system were as follows: (i) an IEC design was carried out and the  $\varepsilon$ -NTU mathematical model was applied to the IEC design; (ii) the numerical results were analysed; and (iii) the IEC system was manufactured.

### 2.1 Description of the indirect evaporative cooler

In the present work was designed an IEC system to handle air in small spaces. The air-cooling device consisted of a compact heat and mass exchanger, a water distributing system and an outer casing.

The heat and mass exchanger was designed with a counter-flow configuration. The air handling process consisted of an inlet air flow, which circulates through dry channels, exchanging heat with the attached channels, see **Figure 1**. The inlet air stream was divided into two air streams at the end of the device, one air stream was recirculated in the inverse direction through wet channels, exchanging heat and mass between air and water, and another stream was supplied, see **Figure 1**. Water only enters wet channels, so the supply air stream was cooled without varying its moisture content.



**Figure 1.** Diagram of the air flows of an IEC system.

### 2.2 Mathematical model of the indirect evaporative cooler

A mathematical model of IEC systems was developed to study the energy performance of an IEC system. This model was based on  $\epsilon$ -NTU numerical method. The main equations of the model are expressed by (1)-(3).

$$NTU = U \cdot dA / C_{min,i} \quad (1)$$

$$U \cdot dA = \left( a \left[ \frac{1}{\alpha_{d,i}} + \frac{\delta}{K} + \frac{\delta_w}{K_w} \right] + \frac{1}{\beta_i} \right)^{-1} N_{ch} W dx \quad (2)$$

$$\epsilon = f(NTU, C_{r,i}) \quad (3)$$

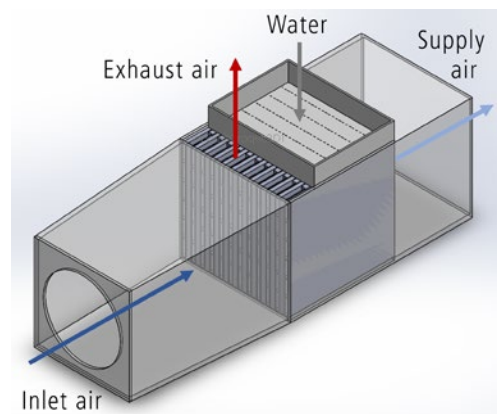
Where  $NTU$  is number of transfer units;  $U$  is overall heat transfer coefficient [ $W \cdot m^{-2} \cdot K^{-1}$ ];  $A$  is area [ $m^2$ ];  $C$  is heat capacity rate [ $kg \cdot s^{-1}$ ];  $a$  is slope of the temperature-enthalpy saturation line [ $kJ \cdot kg^{-1} \cdot K^{-1}$ ];  $\delta$  is thickness of plates [ $m$ ];  $\delta_w$  is thickness of water film [ $m$ ];  $\alpha_{d,i}$  is;  $K$  is thermal conductivity of wall [ $W \cdot m^{-1} \cdot K^{-1}$ ];  $K_w$  is thermal conductivity of water film [ $W \cdot m^{-1} \cdot K^{-1}$ ];  $\beta_i$  is mass transfer coefficient for water vapor [ $kg \cdot s^{-1} \cdot m^{-2}$ ];  $N_{ch}$  is number of channels;  $W$  is width of the exchanger [ $m$ ];  $x$  is distance of sub-heat exchanger [ $m$ ];  $\epsilon$  is effectiveness.

The IEC mathematical model developed allows to determine the optimal geometrical and operating parameters. The IEC mathematical model was implemented in *Engineering Equation Solver* (EES) software.

### 2.3 Manufacturing of the indirect evaporative cooler

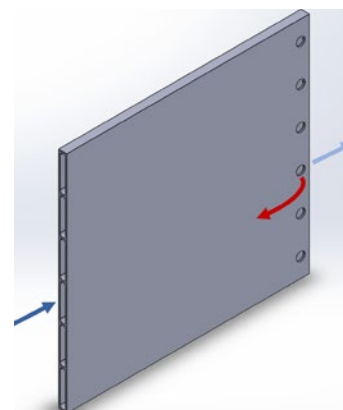
The heat and mass exchanger of the IEC system was manufactured by using 3D printing techniques. 3D printing can be used to manufacture complex design prototypes at a low economical cost. However, the main limitation of this manufacturing technique could be the size of the prototypes.

A design of the manufactured IEC system is shown in **Figure 2**. It can be observed the heat and mass exchanger, a reservoir for water and adapter parts for testing the IEC system. The water distribution was carried out through perforations in the upper part of the device. The driven water came from the network. The exchanger was made up of 12 dry channels and 11 wet channels. The dimensions of the exchanger were 130 mm high, 140 mm long and 116 mm wide, and the material used to make the exchanger was resin [21].



**Figure 2.** Design of the IEC system.

The design of a dry channel of the IEC system is shown in **Figure 3**.



**Figure 3.** Design of the dry channels.



The thickness of the walls was 0.9 mm. These channels were composed of 6 perforations with a diameter of 5 mm. In addition, the wet channels were covered with a thin layer of cotton in order to retain the maximum amount of water.

### 2.4 Evaluation indexes of the indirect evaporative cooler

The performance of the IEC system designed was evaluated under the following ratios:

- Cooling capacity per unit volume of the IEC system, see Eq. (4).

$$C_V = Q_{cooling}/Volume \quad (4)$$

- Cooling capacity per unit airflow rate of the IEC system, see Eq. (5).

$$C_R = Q_{cooling}/V_{supply} \quad (5)$$

Where  $Q_{cooling}$  was computed with energy balance on the dry-side fluid, see Eq. (6).

$$Q_{cooling} = \dot{m} \cdot (h_{out} - h_{in}) \quad (6)$$

Some commercial IEC systems obtained values of  $C_V$  and  $C_R$  of 5.1 kW/m<sup>3</sup> and 23.5 kW/(m<sup>3</sup>/s), respectively [22].

A test facility was used to analyse the experimental performance of the IEC system under different inlet air temperatures, from 27°C to 46°C, and different inlet air flow rate, from 100 m<sup>3</sup>/h to 190 m<sup>3</sup>/h. The supply air flow rates were 75 m<sup>3</sup>/h for the inlet air flow rate of 100 m<sup>3</sup>/h and 115 m<sup>3</sup>/h for the inlet air flow rate of 190 m<sup>3</sup>/h. The value of inlet humidity ratio remained constant, 10 g/kg.

All the experimental tests were carried out under steady-state conditions. The sampling time was 3 seconds, and the values are averaged every 30 min. The accuracy of the measuring devices used was ±0.12°C for the temperature sensors, ±0.15°C for the dew-point temperature sensors and ±0.5% for the differential pressure transmitters.

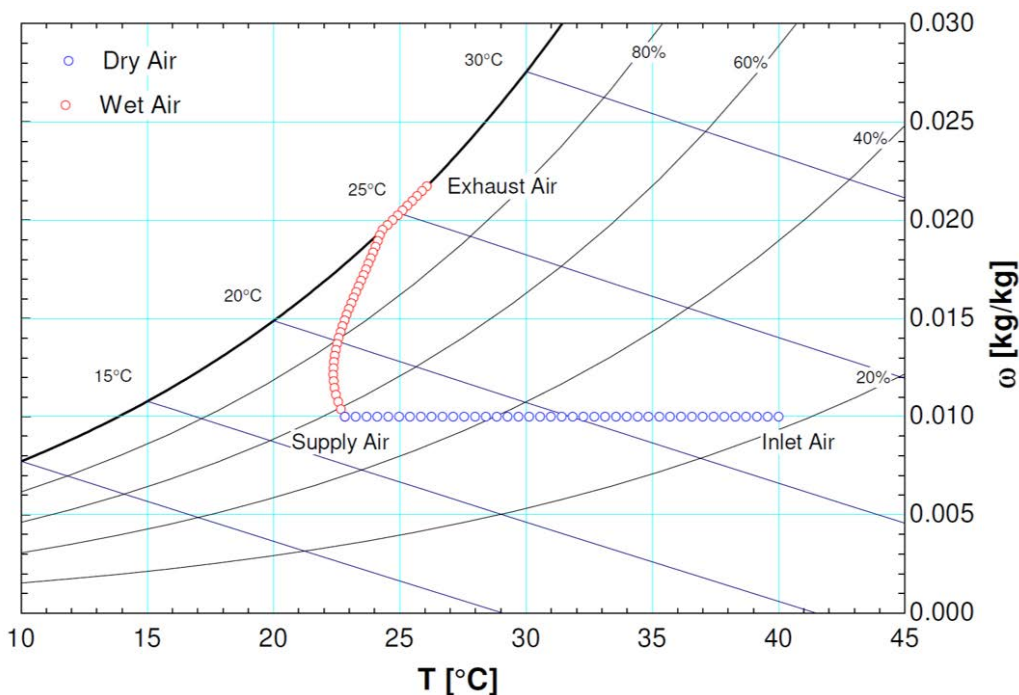
The energy consumption of a fan to overcome the pressure losses of the heat exchanger was calculated with the values of friction losses and minor losses.

## 3. Results

The numerical and experimental results of the manufactured IEC system are shown in this section.

### 3.1 Results of numerical modelling

The mathematical model can be individually applied to  $n$  sub-heat exchangers of an IEC system. For the present work, 60 sub-heat exchangers were considered. As an example, the air conditions of the dry and wet air streams for each computational element of the exchanger are shown in **Figure 4**. This model



**Figure 4.** Psychrometric chart with the dry and wet air streams for each computational element.

allowed to obtain the temperature, enthalpy, and humidity distributions of the air inside the exchanger. Moreover, this mathematical model could be used to obtain the length of the heat and mass exchanger from pre-established inlet and outlet air conditions.

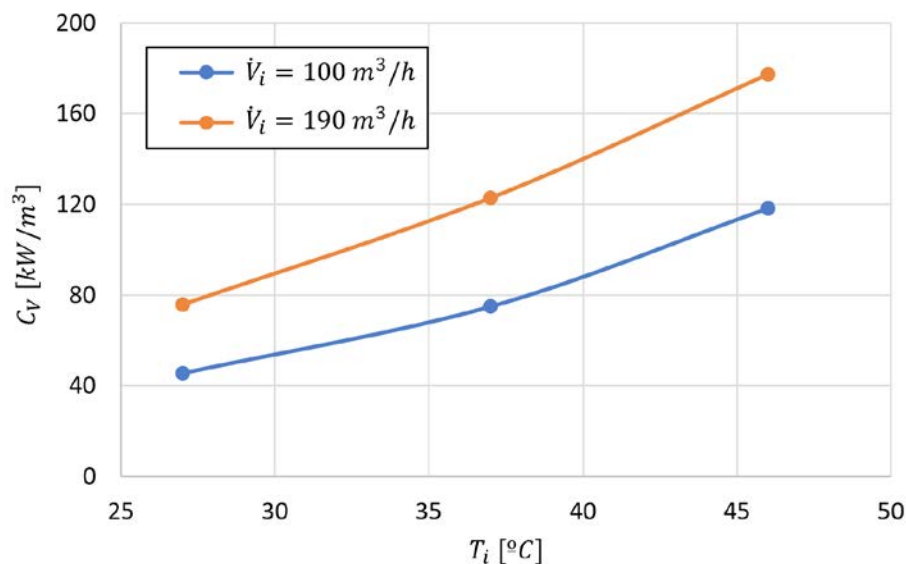
### 3.2 Experimental results

The result of the manufacture of the heat and mass exchanger of the IEC system is shown in **Figure 5**. It can be observed that the exchanger was stacked using dry and wet channels. The wet channels were covered with a thin layer of cotton in order to retain water, which was supplied from the top.

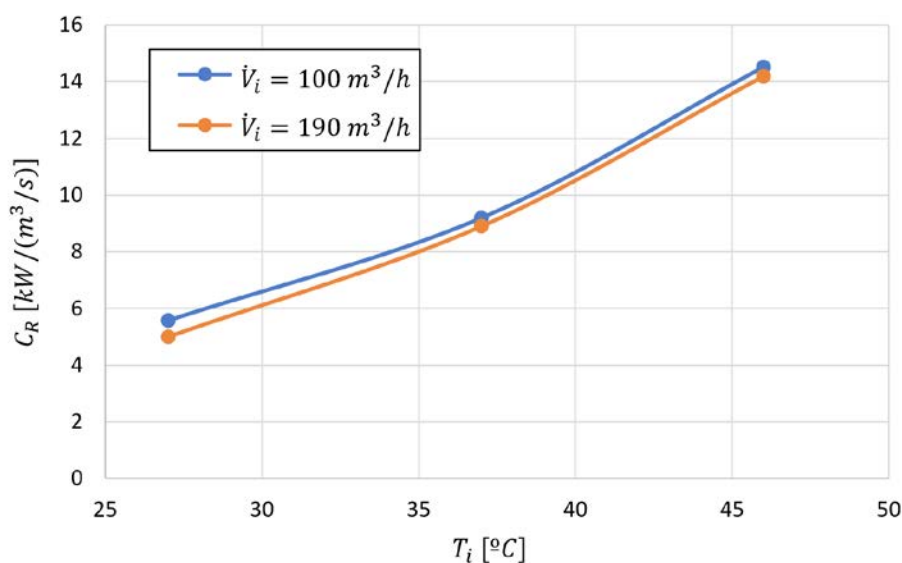


**Figure 5.** Heat and mass exchanger of the IEC system.

The experimental results of  $C_V$  and  $C_R$  for each case study are shown in **Figure 6** and **Figure 7**.



**Figure 6.** Results of cooling capacity per unit volume of the IEC system.



**Figure 7.** Results of cooling capacity per unit airflow rate of the IEC system.

It can be observed that the  $C_V$  values increased when the inlet air temperature was raised, see **Figure 6**. The IEC system also improved the  $C_V$  value when the inlet air flow rate increased from 100 m<sup>3</sup>/h to 190 m<sup>3</sup>/h, as shown in **Figure 6**. The maximum  $C_V$  value was 177 kW/m<sup>3</sup> for an inlet air temperature of 46°C and an inlet air flow rate of 190 m<sup>3</sup>/h. However, the minimum  $C_V$  value was 45 kW/m<sup>3</sup> for an inlet air temperature of 27°C and an inlet air flow rate of 100 m<sup>3</sup>/h. Therefore, the air-cooling device increased its cooling capacity for hot inlet air conditions and higher air flow rate.

The  $C_V$  values obtained in the present work were significantly higher than those obtained by commercial IEC systems, shown in section 2.4. Therefore, the device was designed and manufactured with high compactness.

Regarding  $C_R$ , similar trends to those obtained for  $C_V$  were found when the inlet air temperature increased. That is, the higher the air temperature, the higher the  $C_R$  value, as shown in **Figure 7**. However,  $C_R$  decreased when the inlet air flow rate increased. The maximum  $C_R$  value was 14.51 kW/(m<sup>3</sup>/s) for an inlet air temperature of 46°C and an inlet air flow rate of 100 m<sup>3</sup>/h, and the minimum  $C_R$  value was 5 kW/(m<sup>3</sup>/s) for an inlet air temperature of 27°C and an inlet air flow rate of 190 m<sup>3</sup>/h. For this ratio, the  $C_R$  values obtained in the present work were lower than those obtained by commercial IEC systems, shown in section 2.4. Therefore, the device needed to supply less flow to cool air.

#### 4. Conclusions

In the present work, the geometric design and manufacture of an indirect evaporative cooling (IEC) system was carried out.

The design of the IEC system was achieved from numerical results obtained with a mathematical model based on  $\epsilon$ -NTU numerical method. Moreover, this

model allowed to obtain the temperature, enthalpy, and humidity distributions of the air inside the IEC system.

The experimental performance of the air-cooling device was evaluated under two ratios: cooling capacity per unit volume ( $C_V$ ) and cooling capacity per unit airflow rate ( $C_R$ ). The results showed high  $C_V$  values, up to 177 kW/m<sup>3</sup>, mainly for high inlet air temperatures and inlet air flow rates. The  $C_R$  results were higher for high inlet air temperatures and low inlet air flow rates, with a maximum value of 10.9 kW/(m<sup>3</sup>/s).

These results suggested that highly compact indirect evaporative coolers can achieve air-cooling processes with a low energy consumption and a low environmental impact.

#### Acknowledgement

The authors acknowledge the financial support received by the European Regional Development Fund and the Andalusian Economy, Knowledge, Enterprise and University Council, Spain, through the research project HICOOL, reference 1263034, and by European Union's Horizon 2020 research and innovation programme, through the research project WEDISTRIC, reference H2020-WIDESPREAD2018-03-857801. The present work has also been conducted as a part of the CLIMASEE project 12020113 funded by Diputación Provincial de Jaén.

#### Data Statement

The datasets generated during and/or analysed during the current study are not available because the authors continue to investigate the air-cooling system, but the authors will make every reasonable effort to publish them in near future.

#### References

Please find the complete list of references in the htm-version at <https://www.rehva.eu/rehva-journal> ■

Copyright ©2022 by the authors. This conference paper is published under a CC-BY-4.0 license.

# A common European EPB Assessment and Certification scheme. U-CERT's proposal



**PABLO CARNERO**

Instituto Valenciano de la Edificación, València, Spain  
pcarnero@five.es



**DICK VAN DIJK**

Energy Performance of Buildings (EPB) Center, Rotterdam, the Netherlands



**NICCOLÒ MIGNANI**

Alma Mater Studiorum Università di Bologna, Bologna, Italy



**GABRIELA ANA**

Energy Performance of Buildings (EPB) Center, Rotterdam, the Netherlands

**Keywords:** EPB standards, EPC, EPBD, user-friendliness, digitalisation, indicators, calculation.

## Abstract

Buildings are responsible for great share of the global GHG emissions. Increasing buildings' energy efficiency is crucial to decarbonise the EU. For energy performance policies and requirements to have actual impact on buildings' direct and indirect emissions is crucial to develop robust, accurate, meaningful and user-friendly assessments and certification schemes. This paper presents a methodology .to calculate building energy performance fully compliant with EPB Standards. Also, it proposes a selection of holistic indicators aiming to overcome shortcomings of national energy performance certificates, while being compliant with the latest version of the Energy Performance in Buildings Directive (EPBD). The results have the ambition of laying the foundation for a common European EPB assessment and certification scheme.

## 1. Introduction

Anthropogenic climate change stands as the greatest menace humanity must face in the XXI century. Hence, the adhesion to the International Paris Agreement [1] and

the climate and environment declaration by the European Parliament [2]. Consequently, the European Green Deal [3] established the mission for Europe to be net zero emissions by 2050. The checkpoint of cutting greenhouse gas (GHG) emissions by 55% in 2030 compared to 1990 levels was defined by the Climate Target Plan [4].

Decarbonising our societies calls for multidimensional action, it is widely acknowledged that buildings shall play a key role. During their use and operation, buildings are responsible of over 40% of the energy consumption and represent approximately one third of direct and indirect GHG emissions [5]. Direct emissions caused by their low energy performance and fossil-fuel use [6]. Indirect due to the high energy demand, which strains the power and heat sector. Almost 75% of EU's building stock is inefficient, and over 85% of the buildings that exist today will still be standing in 2050. However, the weighted annual energy renovation remains sunk at 1% [7]. Thus, the 'Fit for 55' package [8] was published with a view to revising the entire climate and energy framework. As a result, the proposal for the Energy Performance in Buildings Directive (EPBD) was



released at the end of 2021 [7]. The document aims at being the definitive push to national building regulation towards delivering the ambitious EU climate targets. A core instrument is the revision of Energy Performance in Building (EPB) Assessments and Certification schemes.

### 1.1. EPB Assessments and Certification schemes

The first version of the EPBD [9] laid down the general framework for calculating buildings' energy performance. Such energy performance shall be assessed in a transparent manner that allowed to verify compliance with minimum requirements established for buildings. Moreover, it should also feed building's energy performance certificates (EPC), posed as the key informative instrument aiming to provoke a shift in the market in favour of efficient constructions. Despite the cardinal rule EPB assessment represented, the specific methodology to obtain it was left to each member state. The definition of a comprehensive procedure capable of assessing buildings' energy performance was far from trivial. When facing such titanic effort, each country defined its own EPB assessment and certification scheme, which generated great discrepancies across the EU [10][11]. In the interest of clarity, the EPBD was recast in 2010 [5]. It further detailed the minimum requirements for energy performance calculations in buildings and mandated member states to consider the existing European standards when developing their national assessment methodologies. A revised version of the EPBD was published in 2018. The document mandated member states to *"describe their national calculation methodology following the national annexes of the overarching standards, namely ISO 52000-1, 52003-1, 52010-1, 52016-1, and 52018-1"* [12]. These standards are part of a coherent set of internationally harmonized procedures developed to assess buildings' energy performance in a systemic manner. They are often referred to as EPB standards and were developed supported by mandate M/480 from the European Commission to CEN.

Many researchers and initiatives have considered the question of EPB assessments and certification schemes in buildings. However, to date, research has given considerably more attention to cross-country comparison and identification of shortcomings [13][14][15][16][17] or auxiliary tool development [18][19], rather than proposing a common-EU methodology considering the set of EPB standards [20].

The main scope of this paper is to propose a methodology for a new energy performance in building (EPB) assessment and to define the corresponding EPC. The remainder of this paper is structured as follows: Section 2 presents the methodology used in the research. Section 3 presents results and discusses

them. Finally, in Section 4, conclusions are set together and policy recommendations are given.

## 2. Research Methods

The research is performed in the scope of the U-CERT project. U-CERT is a Coordination and Support Action funded under the Horizon 2020 programme aiming to define the next-generation EPB assessment and certification scheme leveraging the set of EPB standards.

### 2.1. EPB Assessment methodology

The project deeply mapped the state of the art regarding national EPB assessments and certification schemes in 11 countries (i.e., The Netherlands, Sweden, Estonia, Hungary, Spain, Slovenia, Romania, Italy, Bulgaria, France and Denmark) [21]. The gathering of all available National Annexes, as mandated by [12], was taken as the baseline for the definition of a converged set of EPB standard choices defining the common EU assessment methodology. The procedure was to categorise the EPB Standards to facilitate the identification of the most relevant ones. Next, all Annex A choices were structured and prioritised. Lastly, expert discussions were held in dedicated task forces, using available National Annexes as benchmark, to come to a final decision on U-CERT National Datasheets.

As a result, from the 61 overviewed EPB standards, 10 were finally selected as core of the U-CERT EPB calculation methodology (i.e., EN ISO 52000-1, EN ISO 52010-1, EN 16798-1, EN ISO 52016-1, draft ISO/FDIS 520232-1, EN 15316-4-2, EN 16798-7, EN 16798-5-1, EN ISO 52003-1, and EN ISO 52018-1). Thus, a total of 237 Annex A choices were made. For a detailed description of the selected choices, refer to [22].

Although U-CERT considers measured procedures as valid methods to estimate energy performance in buildings, the lack of EPB standards comprehensively addressing whole building assessments by measurement hindered its thorough analysis.

### 2.2. EPC report

Once having defined the EPB assessment methodologies, U-CERT approached the task of defining the set of indicators and the visual layout of the next-generation EPC. For this purpose, the latest provisions from [7] have been considered.

Apart from the detailed analysis of the two overarching standards dealing with energy performance indicators (i.e., EN ISO 52003-1, and EN ISO 52018-1),

an investigation of the latest developments in Energy Voluntary Certification schemes (EVCS) was also performed [23]. Moreover, parallel to the technical investigation, users' perception regarding EPCs in each of the countries was analysed leveraging ethnographic research techniques [24]. Consequently, to overcome the shortcomings identified in national EPCs (e.g., lack of user-friendliness, reliability, acceptance, etc.), the following briefing for next-generation EPCs was obtained. The objective was to define a flexible EPC, which shall be sensible to the user (i.e., expert and non-expert), to object (i.e., new and existing building), and to assessment type (i.e., calculated and measured). The 'silo-thinking' regarding energy performance should be abandoned, exploiting synergies with other complementary building assessments, such as Indoor Environmental Quality (IEQ), smart readiness, and cost. Furthermore, the next-generation EPC should be designed in a modular fashion, laying the foundation for a digitalised report.

### 3. Results

Although EPB assessments are often focused on standardised calculations (i.e. estimating building energy use under normal use and typical climate conditions), U-CERT allows to produce other types of assessment, as depicted in **Table 1**. They can be mainly clustered in calculated and measured.

The calculated assessment can be applicable to all building situations. In the design for a new construction, the calculations can be arranged to represent standard use and climate, or other project conditions. The first option is usually preferred when dealing with official EPB assessments, whereas the second option is always available for any other tailored analysis. Similarly, when having an existing building, standard or actual conditions can be applied to calculations representing the as built status. In the case of design for renovation, the calculated EPB assessments can

reflect standard conditions, usually applicable for checking requirements or fulfilling regulatory obligations; or project conditions, which can be related to actual building use. The latter of special relevance when envisioning tailored-to-actual use renovation roadmaps. In contrast, the measured assessment is only applicable to as built existing buildings since they require having access to metered data. However, such measurements can be normalised to reflect standard conditions or left as measured to represent actual building use and climate influence and as such to be compared with a tailored calculation. Note that measured EPB assessment can't include an estimation of the building renovation potential.

With respect to the selection of indicators, to be included in the EPC report, there are four categories: energy performance (EP), IEQ, smart readiness and cost. These categories of indicators are sensible to whether they are embedded in calculated or measured EPB assessments, as shown in **Table 2** and **Table 3**.

Note that the indicators included in U-CERT's selection vary depending on the type of assessment. However, all assessments contain general information (e.g., contextual data, identification of the building and the assessor, link to databases, etc.). In the next subsections greater detail is given on the specific indicators within each category.

#### 3.1. Energy Performance

The selection of energy performance indicators can be found in Data access statement.

Data sharing is not applicable to this article as no datasets were generated or analysed during the current study.

The main EP indicator defines the EP rating, according to a single reference point scale ranging from A to G, with the A+ subclass.

**Table 1.** EPB Assessment types. Adapted from [25].

Type	Building situation	Use	Climate
Calculated	Design for new construction	Standard	Standard
		Project	Project
	As built existing building	Standard	Standard
		Actual	Actual
	Design for renovation	Standard	Standard
		Project	Project
Actual		Actual	
Measured	As built existing building	Actual	Actual
		Standard	Standard

### 3.2. Smart Readiness

Smart Readiness refers to the capability of buildings or building units to adapt their operation to the needs of the occupant, also optimizing energy efficiency and overall performance, and to adapt their operation in reaction to signals from the grid. Smart Readiness consideration in the scope of U-CERT's EPB assessment is done by means of the Smart Readiness Indicator, as defined in [26]. This assessment produces an SRI rating.

The fully-fledged SRI assessment could be regarded as a parallel analysis to be included as an annex in EPB Assessments and Certification schemes. ALDREN's EVC goes into this direction [18]. U-CERT is aware that the complete inclusion of SRI as independent from EPB Assessments could represent too much extra work for EPB assessors further hindering the uptake of next generation EPCs. However, if smoothly integrated in the EPB assessment process, added value could be given to EPCs, while not overburdening assessors. For a detailed identification of the overlapping elements between SRI and U-CERT's EPB Assessment, refer to [27].

### 3.3. IEQ

U-CERT decision with respect to including IEQ indicators in EPB assessments and certification schemes is to use the discomfort indicators defined as overall EP indicators (i.e., summer, winter and DHW thermal discomfort), along with the thermal score defined by the ALDREN project in [20].

### 3.4. Cost

In EN ISO 52000-1's Annex B a weighting factor is foreseen for the energy cost. However, U-CERT

considers that for an asset EPB assessment, introducing a cost indicator may be counterproductive. This is because the asset EPB assessment represents the calculated EPB performance under standard conditions and standard weather data. Thus, any cost indicator that builds on such theoretical energy calculations won't provide meaningful information to both final users and EPB experts, who would tend to compare the cost indicator with the information present in the energy invoices.

A calculated cost indicator could be meaningful if it were performed under tailored conditions, rather than standardized. If the EPB assessment were configured to reflect the actual use conditions (e.g., thermostatic setpoints, control strategies, occupant behaviour, etc.) and under actual weather influence, - tailored-to-actual conditions- then the cost indicator could be closer to reflect the actual energy expenditure. Moreover, it could be valuable to use it as baseline model for the ideation of tailored renovation roadmaps.

### 3.5. EPC report

The U-CERT project performed the selection of indicators with a view to easing the integration into building logbooks and EPC databases. Moreover, the EPC report, although produced in a static fashion, it has been structured and designed envisioning evolution to a digital environment. The most relevant feature is the concept of extended and reduced report. The former contains all the indicators and detailed information relevant to an expert user, while the latter just contains the basic insights addressed to a non-expert user. A summary can be found in **Table 4** and **Table 5**.

**Table 2.** Calculated EPB Assessment indicators.

Category	Indicators	U-CERT	
		Included	Left as voluntary
General information		X	-
EP	Overall	X	-
	Partial	X	-
Smart Readiness	SRI	X	-
IEQ	ALDREN Thermal score	X	-
Cost	Cost	-	-

**Table 3.** Measured EPB Assessment indicators.

Category	Indicators	U-CERT	
		Included	Left as voluntary
General information		X	-
EP	Overall	X	-
	Partial	-	X
Smart Readiness	SRI	-	X
IEQ	ALDREN Thermal score	-	X
Cost	Cost	X	-

#### 4. Conclusions

U-CERT sets the foundation of next-generation EPB assessments and certification schemes by producing a calculation methodology fully compliant with EPB Standards. Moreover, it proposes a selection of holistic indicators, covering energy and complementary-to-energy dimensions, and a design of an EPC report which aims to overcome the shortcomings of national procedures. These results have been produced considering the latest provisions from [7]. Thus, they have the ambition of laying the foundation of a common European EPB assessment and certification scheme. Member states may find in U-CERT's value propositions a valuable stepping stone when aiming to renew their national procedures when having to transpose the EPBD to their national regulation.

Although progressing on existing research, this investigation is not exempt from limitations. In the scope of the project, it was possible to retrieve users' perception on existing national EPCs from 11 countries. Nevertheless, replicating the methodology with the new EPC report was not possible during project duration. Furthermore, the calculation methodology has not been transferred to a functional simulation software. The EPC report could not be digitalised. These last two endeavours are left to future research.

#### 5. Acknowledgement

The research was performed under the U-CERT project. Thus, the authors would like to acknowledge the technical support from the project consortium and the financial support of the European Commission under the H2020 programme. U-CERT received funding from the European Union's Horizon 2020 research and innovation programme under grant agreement number 839937.

#### 6. Data access statement

Data sharing is not applicable to this article as no datasets were generated or analysed during the current study.

#### Acknowledgement

This article is prepared within the scope of [U-CERT project](#), which has received funding from the European Union's Horizon 2020 research and innovation programme under the grant agreement number 839937. The European Union is not liable for any use that may be made of the information contained in this document, which is merely representing the authors' views.



*Table 4. Calculated EPC report. Content overview.*

Calculated EPB Assessment	Reduced	Extended
<b>Existing building or new building</b>		
<b>General information</b>	X	X
Main EP rating in scale	X	X
Thermal comfort rating in scale	X	X
Smart Readiness in scale	X	X
<b>Overall EP indicators</b>	-	X
<b>Partial EP indicators</b>	-	X
<b>SRI report</b>	-	X
<b>ALDREN Thermal score report</b>	-	X
Voluntary indicators as annexes	-	X
<b>Renovation potential</b>		
<b>per each renovation action</b>		
Description of renovation action	X	X
Main EP rating in scale	X	X
Thermal comfort rating in scale	X	X
Smart Readiness in scale	X	X
Cost of renovation action	X	X
<b>Overall EP indicators</b>	-	X
<b>Partial EP indicators</b>	-	X
<b>SRI report</b>	-	X
<b>ALDREN Thermal score report</b>	-	X
Voluntary indicators as annexes	-	X
<b>for the complete renovation scenario</b>		
Description of renovation scenario	X	X
Main EP rating in scale	X	X
Thermal comfort rating in scale	X	X
Smart Readiness in scale	X	X
Cost of renovation scenario	X	X
<b>Overall EP indicators</b>	-	X
<b>Partial EP indicators</b>	-	X
<b>SRI report</b>	-	X
<b>ALDREN Thermal score report</b>	-	X
Voluntary indicators as annexes	-	X

*Table 5. Measured EPC report. Content overview.*

Measured EPB Assessment	Reduced	Extended
<b>Existing building or new building</b>		
<b>General information</b>	X	X
Main EP rating in scale	X	X
Thermal comfort rating in scale (if performed)	X	X
Smart Readiness in scale (if performed)	X	X
<b>Overall EP indicators</b>	-	X
<b>Partial EP indicators (if performed)</b>	-	X
<b>SRI report (if performed)</b>	-	X
<b>ALDREN Thermal score report (if performed)</b>	-	X
Voluntary indicators as annexes	-	X

The EPC report template design has not been reproduced here due to space restrictions. It can be found in [27].



## 7. Appendix A

The indicators considered for U-CERT's EPB assessments can be classified into overall and partial indicators. The overall indicators include the following<sup>1</sup>:

- Overall non-renewable primary energy use [kWh/m<sup>2</sup>] [kWh]. Calculated according to H5 in Annex H in ISO 52000-1 [2]; thus, considering compensation between different energy carriers and the effect of exported energy.

This indicator assesses the final global impact the energy performance of the building has. An excess consumption during certain moments during the year may be balanced by surplus of energy in others. It constitutes the main EP indicator. This is in line with ALDREN project [18].

- Overall total primary energy use [kWh/m<sup>2</sup>] [kWh]. Calculated according to H4 in Annex H in ISO 52000-1 [2]; thus, not considering compensation between different energy carriers nor the effect of exported energy.

This indicator assesses the total primary energy the building requires to operate according to the energy needs, technical building system efficiency and renewable contribution to the onsite energy use. It seeks to prevent buildings to balance a poor envelope and inefficient systems with oversized renewable generation.

- Summer thermal comfort [K·h].

This indicator serves to account for overheating during the cooling period. It refers to the amount of (weighted) occupation hours the temperature is above a certain reference temperature.

- Winter thermal comfort. [K·h].

This indicator serves to account for underheating during the heating period. It refers to the amount of (weighted) occupation hours the temperature is below a certain reference temperature.

- Domestic Hot Water thermal comfort [K·h].

This indicator serves to check that sanitary hot water is provided, when there is demand, at a certain minimum reference temperature.

Additionally, the following overall indicators are considered of informative nature.

- Overall non-renewable primary energy use [kWh/m<sup>2</sup>] [kWh]. Calculated according to H4 in Annex H in ISO 52000-1 [2]; thus, not considering compensation between different energy carriers nor the effect of exported energy. This indicator is also compliant with Level(s).
- Overall renewable primary energy production [kWh/m<sup>2</sup>] [kWh]. Considering the whole renewable primary energy production, regardless of whether consumed onsite or exported to the grid.
- Overall renewable primary energy use [kWh/m<sup>2</sup>] [kWh]. The portion of the previous indicator compensating the energy demanded by the uses considered in the assessment.
- Overall equivalent CO<sub>2</sub> emissions [kg/m<sup>2</sup>]. Calculated following H5 in Annex H in ISO 52000-1 [2]; thus, considering compensation between different energy carriers and the effect of exported energy.
- Renewable electricity generation by onsite PV, wind turbines or CHP [kWh/m<sup>2</sup>] [kWh].
- Renewable electricity from onsite PV, wind turbines or CHP self-used [kWh/m<sup>2</sup>] [kWh].
- Renewable electricity exported to non-EPB uses by onsite PV, wind turbines or CHP [kWh/m<sup>2</sup>] [kWh].
- Renewable electricity exported to the grid by onsite PV, wind turbines or CHP [kWh/m<sup>2</sup>] [kWh].
- Energy needs per service – heating, cooling, domestic hot water, humidification and dehumidification, and mechanical ventilation - [kWh/m<sup>2</sup>].

For the case of the lighting, the metric proposed would be the Daylight Autonomy (DA). Thus, the indicator of the lighting energy needs would be the percentage of the occupied hours of the year when artificial lighting is needed, because daylight alone can't meet the minimum illuminance threshold [19].

- Energy use per system service – heating, cooling, domestic hot water, humidification and

<sup>1</sup> Because of the ongoing discussions regarding the EPBD recast, some fine-tuning of the proposed main indicators is not excluded.

dehumidification, mechanical ventilation, and lighting - and energy vector [kWh/m<sup>2</sup>] [kWh].

The partial indicators cover physical and technological elements, which could have strong connection with building and system inspections. They can be subdivided into envelope, technical building systems and renewable electricity production performance indicators.

The envelope performance indicators selected to be included in U-CERT are the following:

- Per opaque envelope construction.
  - Thermal transmittance [W/(m<sup>2</sup>·K)];
  - Colour outside layer;

Additionally, a description of the layered materials should be included. It should cover (from outer to inner element), at least name, thickness, and conductivity of the material. Other features, such as density or specific heat may also be included.

- Per window/skylight:
  - Thermal transmittance [W/(m<sup>2</sup>·K)];
  - Opening control (e.g., manual or fixed windows, open/closed detection to act on HVAC, based on sensor data, etc.)
  - Solar shading of glazings:
    - Presence;
    - Technology (e.g., awning, blinds, shutters, etc.);
    - Control (e.g., manual, motorized, automation based on sensor data, combined control with HVAC, predictive control, etc.)
    - Solar shading potential [%], according to ISO 18292 [20];
  - Glass thermal transmittance [W/(m<sup>2</sup>·K)];
  - Glass solar factor [-];
  - Frame thermal transmittance [W/(m<sup>2</sup>·K)];
  - Frame colour or absorptance.
  - Air permeability class, according to EN 12207.

Additionally, a description of each representative window/skylight should be included.

- Thermal bridges, per type of junction (e.g., corner, slab-façade, pillar, etc.):

- Linear thermal transmittance  $\Psi$  [W/(m·K)].
- Length [m].

- Air leakage:
  - Air change rate at 50Pa [1/h].

This indicator should be measured by means of a Blower Door test according to EN 13829 [21] whenever possible, and its value should be included in the calculations.

Continuing with the infrastructure present in the building, the technical building systems per service also provide valuable information about the energy performance of the building, as a whole.

- Technical Building Systems per service or combination of services.

Additionally, to the categories presented below, a general description of the installation should be included.

- Service or services linked to the system.
- Overall installation efficiency.
- Generation:
  - Technology (e.g., conventional boiler, condensing boiler, air-to-air heat pump, electric heater, etc.);
  - Energy carrier;
  - Nominal power [kW];
  - Effective rated output [kW];
  - Nominal efficiency [%];
  - Renewable contribution (if applicable);
  - Metering;
  - Control (e.g., on-off control; control according to fixed priority list; control according to dynamic priority list; control according to dynamic priority list and predicted information; control according to dynamic priority list, predicted information and external signals).
- Storage:
  - Capacity [m<sup>3</sup>].
  - Control (e.g., continuous storage operation, scheduled storage operation, load prediction-based storage operation, flexible control according to external signals, etc.).

- Distribution:
  - Typology of circuit (e.g., two-pipe, four-pipe, recirculation, etc.);
  - Insulation of pipes; Further detail may be included.
  - Circulation device (e.g., pumps, fans, etc.). Further detail may be included.
  - Control (e.g., on-off control, multi-stage control, variable speed circulation device control based on internal signals or on external signals).
- Emission:
  - Technology (e.g., radiators, heated floor, fancoils, etc.);
  - Control (e.g., central automatic control, individual room control, individual room control with communication between controllers and to BACS, individual room control with communication and occupancy detection).
- Reporting of performance (e.g., central reporting of KPIs, historical data, forecasting and/or benchmarking, predictive management, and fault detection, etc.).

The aim is to characterize the main elements of the Heating, Cooling, DHW, Humidification & Dehumidification, and Mechanical Ventilation technical systems.

With respect to Lighting, the following may apply:

- Technology (e.g., LED, dichroic, fluorescent, etc.).
- Nominal power;
- Control (e.g., manual, sweeping extinction signal, automatic detection, etc.).

If there is a certain service which lacks technical building system, it should be explicitly mentioned.

U-CERT proposes including the following indicators about renewable electricity production.

- Photovoltaics:
  - Technology (e.g., monocrystalline, etc.).
  - Installed peak power [kWp].
  - Nominal efficiency [%].
  - Orientation [°].
  - Inclination [°].

- Possibility to export electricity to the grid.
- Inverter type (e.g., central inverter, power optimizer + inverter, or microinverters).
- Reporting of performance (e.g., current generation data, actual values and historical data, performance evaluation including forecast and/or benchmarking, predictive management, and fault detection, etc.).
- Wind turbine:
  - Technology.
  - Installed peak power [kWp].
  - Nominal efficiency [%].
  - Possibility to export electricity to the grid.
  - Reporting of performance (e.g., current generation data, actual values and historical data, performance evaluation including forecast and/or benchmarking, predictive management, and fault detection, etc.).
- CHP:
  - Installed peak power [kWp].
  - Technology.
  - Nominal efficiency for thermal and power generation.
- Storage:
  - Technology (e.g., dedicated battery storage, dedicated thermal energy storage, etc.).
  - Installed peak capacity [kWh].
  - Control (e.g., direct storage of on-site production, controlled based on grid signals, optimising the use of locally generated electricity, possibility to feed back into the grid, etc.).
  - Reporting of performance (e.g., current state of charge, actual values and historical data, performance evaluation including forecast and/or benchmarking, predictive management, and fault detection, etc.).

In the case the building or building unit is connected to an energy community or district heating/cooling network it should also be made explicit.

## References

Please find the complete list of references in the htm-version at <https://www.rehva.eu/rehva-journal> ■

# Review of Certification Procedure for Inverter Air Conditioner

Considerable technology advancement in comfort air-conditioners designs over the past few decades have seen a substantial development in the variable speed compressor operation (inverter air-conditioner). Most of the current international standards allows the intervention when testing these units to provide the setting parameters, while some still forbid it to prevent manufacturer interference.

This study reviews the testing methods of the two types of air-conditioners in the different scientific literature and international standards. The results showed that it is not possible to test the IAC unit on a fixed rating capacity without providing the setting parameters such as the compressor speed and frequency and the fan speed. To guarantee no further interference from the manufacturer, using a third-party certification body has showed an efficient solution until further development of the testing methods.

## Introduction

Interest for air-conditioning (AC) systems has exponentially expanded worldwide throughout the most recent couple of decades. The global market size was valued at 106.6 billion USD in 2020 with an expected compound annual growth (CAGR) of 6.2% until 2028 [1]. The expanding rate of electricity and aggressive effect on the environment from power generation pushed to substantial developments in the variable speed compressor (inverter). The inverter segment account for 50% of the market in India [2] and is projected to expand globally at a CAGR of 7.7% [1] in a 6-year period. This growth is attributable to inverter AC's (IAC) due to the difference in operation comparing to conventional AC's. An AC is a mechanism designed to maintain and control the air temperature and humidity within an area. The operation is typically

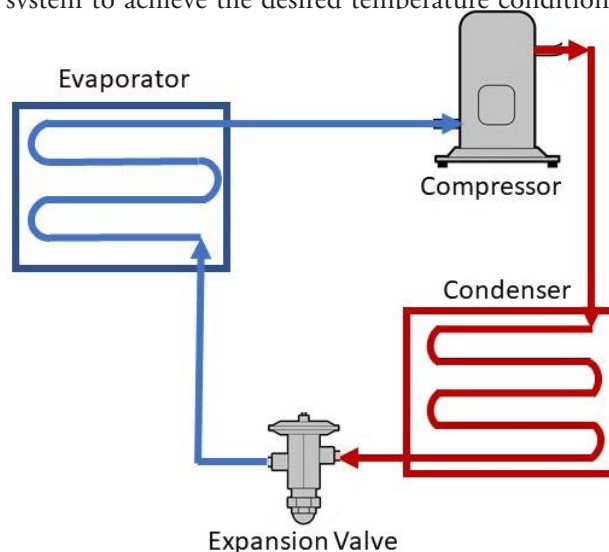


**ALI NOUR EDDINE**

Dr, Air-Conditioner program manager, Eurovent Certita Certification, Paris, France  
aa.nour-eddine@eurovent-certification.com

performed by a simple refrigeration (vapor compression) cycle (**Figure 1**).

A typical refrigeration cycle uses an electric motor to drive the compressor. The two most common types of compressors are the 'fixed speed' type and the 'variable speed' (inverter) types. With conventional 'fixed-speed' air conditioners, the compressor is either on (working to 100% capacity) or off. An inverter in an air conditioner is used to change the compressor's motor speed to drive variable refrigerant flow in an air conditioning system to achieve the desired temperature conditions



**Figure 1.** Simple refrigeration cycle



in indoor space. It maintains the desired temperatures without wild fluctuations. **Figure 2** shows the difference in room temperature fluctuation between fixed speed and IAC units. IAC provide ability to control the speed of the compressor motor which helps in continuous regulation of temperature. It also helps in saving energy and power with the help of a variable speed compressor. Additionally, other benefits such as no temperature fluctuations, longer durability, faster cooling, and reduced noise in comparison with non-inverter ACs are expected to fuel the demand for inverter technology.

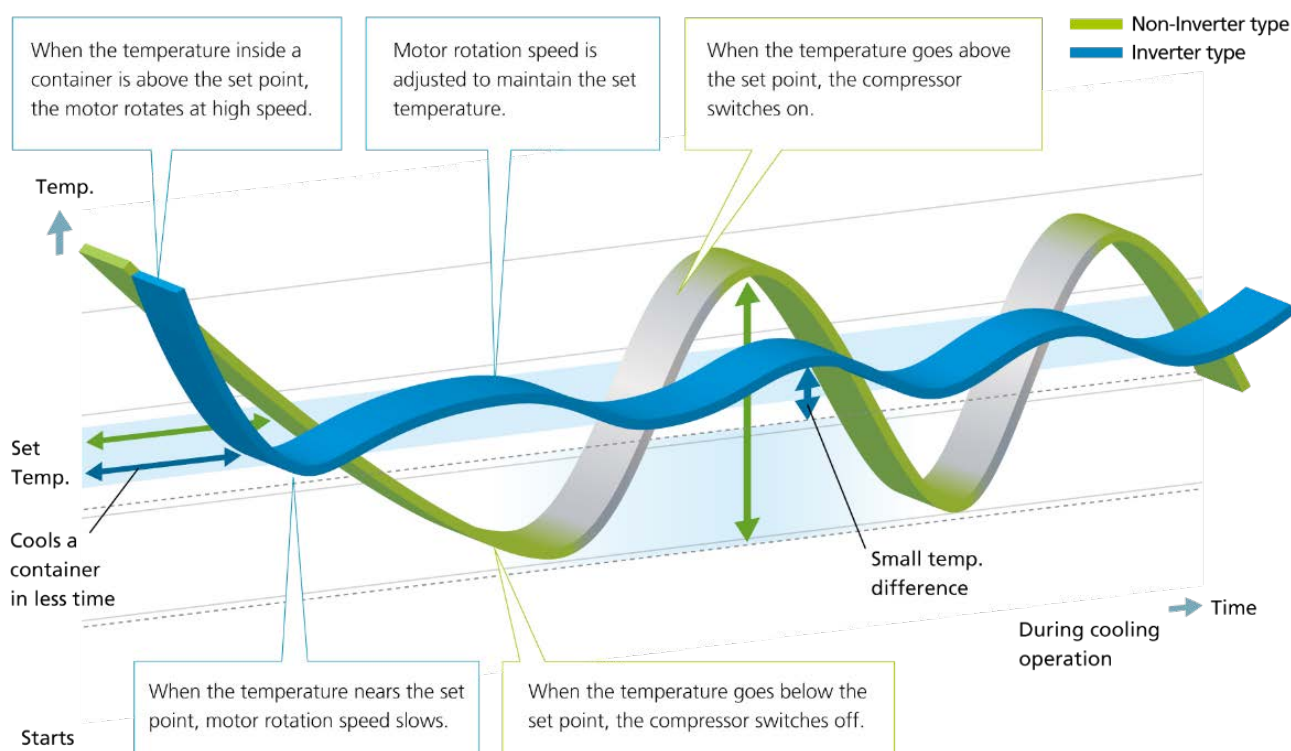
The fundamental difference in operation required further investigations through the years to validate the efficiency of testing and rating IAC units using the same methods of conventional AC's. Mavuri et al. [3] tested IAC using the calorimeter test method. The results showed that to test the IAC on part load on specific room temperature conditions, it should either be in a locked mode where the instruction for fixing the compressor speed is supplied by the manufacturer and the capacity is directly proportional to the compressor speed, either testing the IAC in a field operation mode by fixing a thermal load instead of fixed room temperature or capacity. The dependency of the unit capacity to the compressor frequency has also been showed in a thermal model created by Hui et al. [4]. Another study [5] on the effect of unlocked test using the calorimeter room method on the Minimum

energy Performance Standards (MEPS) on IAC results in some unit failing to comply with the MEPS requirements and consumed much higher level of electricity compared to a fixed load or locked capacity test. This result is far from real life performances since it was proven by several field studies that IAC enormously reduce power consumption in comparison to conventional AC's such as Almogbel et al. [6] who studied the energy consumption of an AC and an IAC for 108 days, and showed 49% less energy consumption of the IAC comparing to conventional AC.

Despite clear scientific evidence of the difference in operation of the conventional AC and IAC, there is no definitive solution in the international regulation to differentiate the testing procedure of these two types of units. This article presents the adopted solutions of the regulation's commissions in different countries and the feedback and experience of Eurovent Certita Certification (ECC) body for this matter.

### Inverter Air-Conditioner Testing schemes

For a variety of HVAC equipment, many testing methods have been developed. Heating balance method (calorimeter room method) and enthalpy difference method are commonly used for testing HVAC equipment.



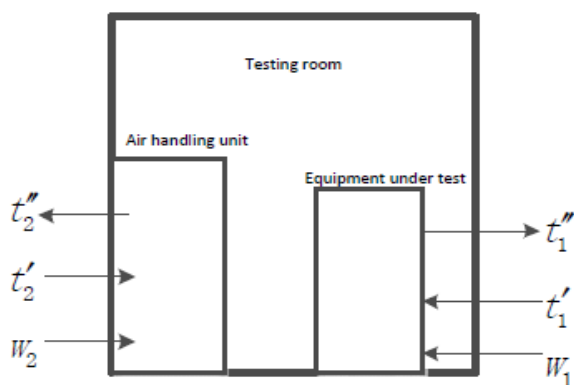
**Figure 2.** Room temperature operation for AC and IAC [11]

Calorimeter Room (**Figure 3**) test heat balance test device is a room air conditioning performance test device. The method of calibrating the performance of air conditioner with calorimeter test bench is called Room heat balance method. The basic principle is based on the law of conservation of thermodynamics (the first law of thermodynamics): that is

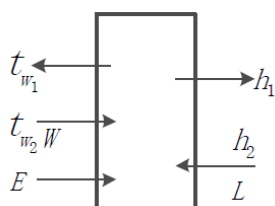
$$\text{Input Energy} = \text{Output Energy}$$

The air enthalpy difference method (**Figure 4**) is a way to test the performance of the air conditioner by measuring the enthalpy and the circulating air volume of the air at the inlet and outlet of the air conditioner. It consists of measuring the enthalpy difference of the inlet and outlet air inside the air conditioner chamber and calculate the air conditioner capacity through the heat exchanger air flow. The enthalpy is measured by measuring the temperatures of dry and wet bulbs ( $T$ - $T_s$  method).

When testing the IAC freely without setting the parameters from the manufacturer, the capacity of the unit would not be constant even if the ambient temperature is constant. The internal control of the unit will compensate for the thermal load of the room. The IAC unit will be checking the air temperature from time to time using its own sensor and will adapt with the capacity being delivered to compensate the thermal load. If the unit determine that the temperature is going down in



**Figure 3.** Calorimeter Room method schematic [7]



**Figure 4.** Enthalpy difference method schematic [7]

a cooling capacity test then the unit will realize that the capacity delivered is too much and it will reduce the capacity by reducing the compressor frequency. On the opposite side, if the ambient conditions are going up, then the unit would increase the capacity by increasing the compressor frequency and the fan speed and the electronic expansion valve on both sides of the unit.

During the test of IAC, to maintain the unit on a fixed capacity, the operational parameters of the unit should be fixed (compressor frequency, electronic expansion valve and the fan speed). As one can see from how both testing methods function, the IAC with a variable capacity could not be tested using the calorimeter room method and is too difficult to test using the air enthalpy method.

Therefore, in the current state of available technology, testing an IAC should require setting fixed parameters such as compressor speed and frequency and in some cases fan speed and the expansion valve opening. This could be done by manually involving a thermostat included in the unit or automatically with a pre-set parameters in what is called testing mode. This procedure aims to convert the IAC unit into a fixed speed compressor unit for testing purpose.

### International regulations and standards for testing IAC's

The test procedures for Air Conditioners are slightly different between each governing body. With different climates and equipment markets in each country, the high and low temperature test conditions each test procedure are slightly different. This section discusses the scope of each test procedure and reviews their similarities when testing the IAC's [8].

#### ISO

The ISO standard 5151 [12], which is incorporated either by reference or in full by many countries, applies to non-ducted air-cooled ACs and air-to-air heat pumps, and small ducted ACs and heat pumps. The scope of the standard covers both packaged and split systems but limits the split systems to multi-split systems controlled by a single thermostat. The standard specifies that single capacity, variable capacity, and multiple capacity units are also covered.

#### Australia

The Australian standard, AU/NZ 3823.4.1, covers air-cooled ACs and air-to-air heat pumps. This test method is the ISO 16358 standard, which incorporates the entire scope of ISO 5151, ISO 13253, and

ISO 15042. ISO 13253 covers ducted air-cooled air conditioners and ducted air-to-air heat pumps. ISO 15042 is the test procedure that covers multi-split and multi-circuit non-ducted systems. Both single and variable capacity systems are covered.

### China

The Chinese standard GB/T 7725-2004 test procedure applies to non-ducted units with a cooling capacity below 14 kW. The units can be either water-cooled or air-cooled.

### European Union

The EU test procedure covers both packaged and split system ACs and heat pumps. These products can be variable capacity by any means, ducted or non-ducted, single-split or multi-split systems. The definition for multi-split from the EU aligns with the US definition (below). As for IAC's the EN 14511 clearly states that the setting of the frequency shall be done for each rating condition. The manufacturer shall provide in the documentation information about how to obtain the necessary data to set the required frequencies and/or the fan when different from the maximum one to set on the control device for a given rating condition.

It even allows when skilled personnel with knowledge of control software is required for the start of the system, the manufacturer or the nominated agent should be in attendance when the system is being installed and prepared for tests.

### Japan

The Japanese standard JIS B 8615-1:2013 and JIS B 9612:2013 applies to packaged and split system ACs with a rated cooling capacity of 10 kW or less. Japan references ISO 5151 for its standard, with country specific adjustments to the testing conditions.

### Korea

Korea's standard KS C 9306 2017 test procedure is limited to packaged and split systems with a rated cooling capacity of 35 kW or less. The main deviation in scope from the other countries is the exclusion of split systems with multiple indoor units.

### United States

The test procedure established by the United States was updated in 2017, and a new test procedure will go into effect in 2023. The current test procedure covers both heat pumps and ACs configured as single package units and split system units. The standard specifies that the split system units can be designed as multi-head mini split, multi-split, and multi-circuit systems.

As a US certification body, the AHRI standard 1230-2010 allows skilled personnel from the manufacturer to intervene to set the control software for an IAC. In addition to setting the compressor frequency needed to operate at targeted nominal capacity.

### Canada

The Canadian testing procedure are presented in the CSA EXP07 SCOP, ICOP. It allows using both air enthalpy and calorimeter room methods depending on the type of the unit. It covers both fixed and variable speed compressor types.

In all the presented standards, variable capacity units are currently tested at fixed compressor speeds. When installed, the speed of the compressor increases/decreases dynamically to condition the space. To test these units in a fixed-speed mode, a lab/testing body must contact the manufacturer to upload specific software or connect specific equipment to force the unit into a testing mode. The necessity of manufacturer intervention when testing these units opens up the procedure to interference by allowing changes to be made to the unit that are not present when operating in the field.

While there is no other available solution in the present, both Canada and the EU are working to establish dynamic load-based test procedures for room air conditioners and heat pumps. These proposed test methods (CSA EXP07 and EN 14825) use an adaptation of the psychrometric approach to introduce sensible and latent heat loads to the indoor room and test the unit's control scheme for managing space temperature. The goal of developing these test procedures is to reflect the operation of a unit more closely in the field, which would better characterize unit operation at lower temperatures, better represent the efficiency gains associated with variable speed equipment and eliminate the ability to override controls. There are other initiatives such as keeping the same test method but introducing verification after or before the test to check that the inverter unit run at the same parameters in real life conditions than those used for the test.

These test procedures are in the process of being developed, and some have raised concerns that the inherently dynamic nature of such test approaches may make them difficult to reproduce. Until one of these methods is valid enough, referring to a third-party certification body that controls the communication between the laboratory and the manufacturer could be the best available solution for testing an IAC by allowing the manufacturer to provide the required

parameters for testing while ensuring no further modifications or intervention on the unit.

### Eurovent Certita Certification (ECC) feedback and experience

Established in 1993, Eurovent Certita Certification is recognized as a world leader in third-party product performance certification in the Heating, Ventilation, Air Conditioning, and Refrigeration fields. In the Technical Certification Rules document (TCR) [9] for the Air-conditioners, it covers in its scope Comfort air cooled air conditioners and air/air heat pumps rated up to 100 kW cooling capacity. The program follows the standards EN 14511 [13] and EN 14825 [14] for the testing methods and procedures. All the certified products and performances are available the ECC website [10].

In application of the Certification Manual (CM) and the TCR of the program, ECC forbid any direct communication between the manufacturer and the laboratory. The communications should be restricted with those allowed by the standards such as installation/ start up procedure and information about the compressor frequency and fan speed for the case of inverter. This information is collected using a locked document provided to the manufacturer by ECC and the necessary information are then transferred to the laboratory. Any further required information by the laboratory should be acquired by the intermediate of the certification team.

Currently ECC have 6217 certified Air-Conditioner on its website. The IACs represent the larger part of these products (Figure 5). The control of all communication

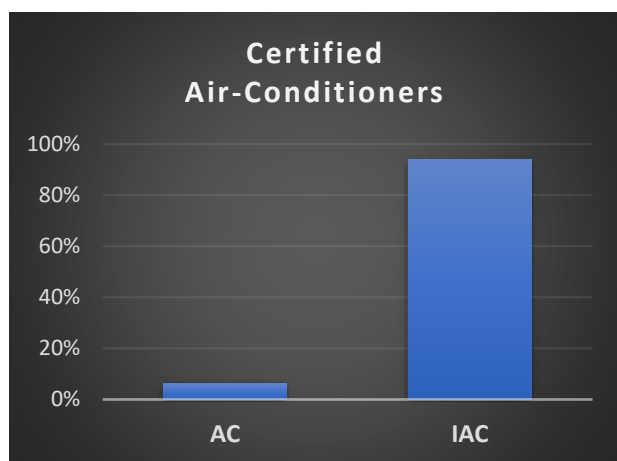
between the laboratory and the manufacturer guarantees the testing body should have all the required information for following the testing standards while restricting the intervention of the manufacturer not allowing any changes to be made to the unit that are not present when operating in the field. This could be visible in the results of the 2020 surveillance campaign where 7% (Figure 6) of the tested seasonal efficiencies has been rerated, even though that the manufacturer provided the setting parameters for the IACs as allowed by the standards.

### Conclusion

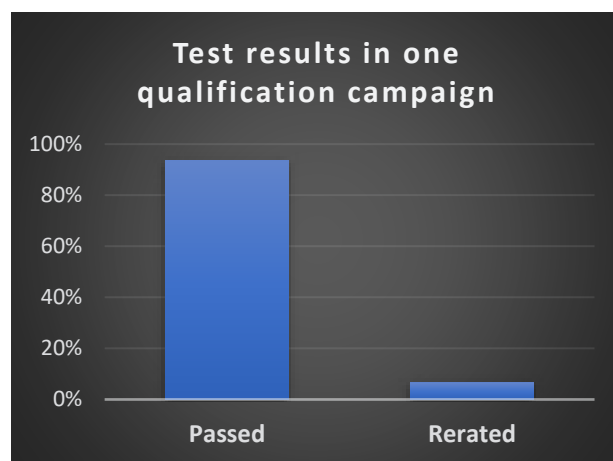
IAC and AC have a different type of compressor and though different functionality. According to the reviewed established test procedure, IACs are currently tested at fixed compressor speeds. To achieve that, the current test standards allow IAC manufacturer to lock the compressor speed for a desired rated capacity. This could be done by setting the parameters of the unit on each of the targeted capacity tests. This requires an allowed intervention of the manufacturer when testing these units which opens the procedure to interference. The EU and Canada are working on other test methods to prevent this intervention, in the meanwhile using a third-party certification body such as ECC proved to be an efficient method to perform the test while guaranteeing the minimum required intervention of the manufacturer.

### References

Please find the complete list of references in the htm-version at <https://www.rehva.eu/rehva-journal> ■



**Figure 5.** Certified Air-Conditioner by ECC following 2021 campaign



**Figure 6.** Test results for the 2020 campaign



# Optimising energy efficiency through system accuracy



## Discover the benefits of **sustainable indoor climate comfort**

With approximately 40% of the EU's energy consumption related to buildings and indoor climate systems, we are committed to delivering energy-optimised solutions that do not compromise the comfort demands of modern living.

Our low temperature hydronic systems offer an optimal way to improve energy efficiency through high-levels of system accuracy and function control which results in precise temperature management. This accuracy enables the temperature to be adjusted quickly and consistently throughout the room, leading to better comfort and lower energy consumption.

Discover more at [www.purmogroup.com](http://www.purmogroup.com)

**PURMO**  
GROUP

# Deep energy renovation, the effect of airtightness and heat recovery in renovation projects



**MIKKO IIVONEN**

MSc (Tech)  
REHVA Fellow  
PURMO Group Plc  
mikko.iivonen@purmogroup.com

## Introduction

Both discussions and published articles often talk about the need to improve a building's thermal insulation. It is often thought that thermal insulation, new windows and exterior doors are key to the energy efficiency solution of renovation construction. However, it is not that simple. Improving the U-values of the building envelope is only one part in the pursuit of energy efficiency. Something that is not given enough attention is the building's airtightness and heat recovery. It has significant impact on both energy efficiency and the functionality of the building.

Making technical improvements, such as choosing the right heat generation, hydraulic balancing of the heating network, resizing the radiators to new low system temperature conditions and selecting proper control devices are other key measures. On-site electricity production is also easy to install. Many buildings need cooling, but this is often not considered in renovation. In addition to these, a well-functioning ventilation system is essential, both for the residents' health and the condition of the building. Therefore,

energy-efficient renovation package is technically demanding and must be planned and implemented professionally. All areas must function as planned. There are too many failed renovated apartment and single-family buildings, where goals have not been achieved and sometimes a mouldy, "sick building" has resulted in exchange for high costs.

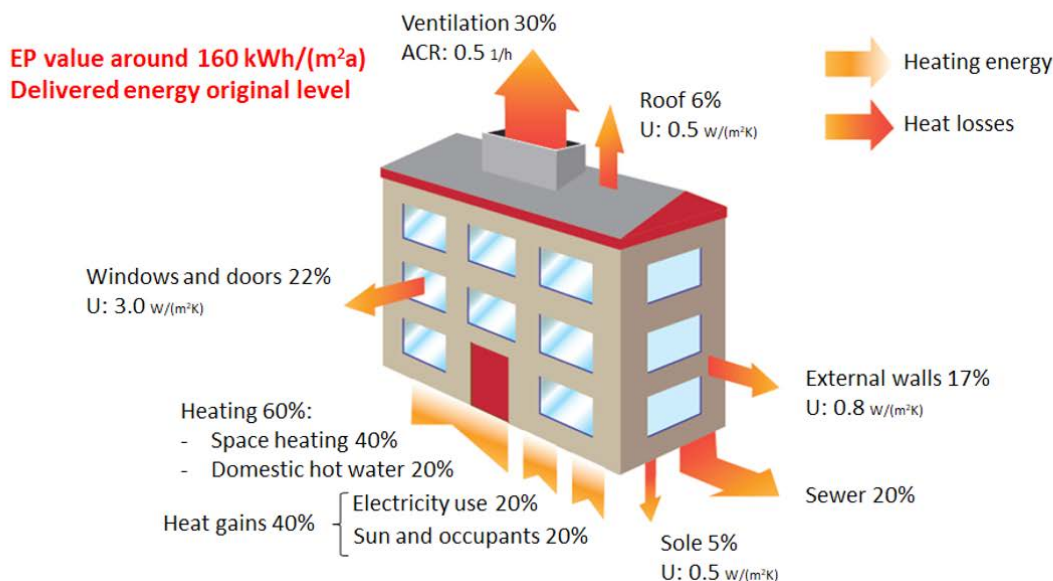
## Energy balance of building

The following pictures show the energy flows of a Nordic residential apartment building as an example. The example building, **Figure 1**, is relatively energy efficient in an European scale for an old building and has good air tightness, EP value 160 kWh/(m<sup>2</sup>a), while the European average lies around 200 – 250 kWh/(m<sup>2</sup>a). The heating energy input of the sample building consists of space heating 40%, domestic hot water 20% and heat gain 40% including use of electric appliances, sun radiation and occupants. Heat losses mainly consist of ventilation exhaust air 30%, windows and doors 22%, sewage water 20%, walls 17%, roof 6% and soil 5%.

When the outer shell of the building in question is renovated, the windows are renewed and thermal insulation is added to the outer walls including under the roof and the building's energy flow ratios change, as shown in **Figure 2**. Despite the significantly improved U values, the building's EP value only improves by 28% to 115 kWh/(m<sup>2</sup>a).

These repairs are typically the most expensive part of a deep energy renovation and the benefit achieved is not sufficient. Observations indicate that in order to improve the energy efficiency at least by 50%, heat recovery is typically required from the ventilation exhaust air that forms the largest part of losses at 45%. Another important potential for heat recovery is sewage water

### Typical apartment building from the 1950s-1970s

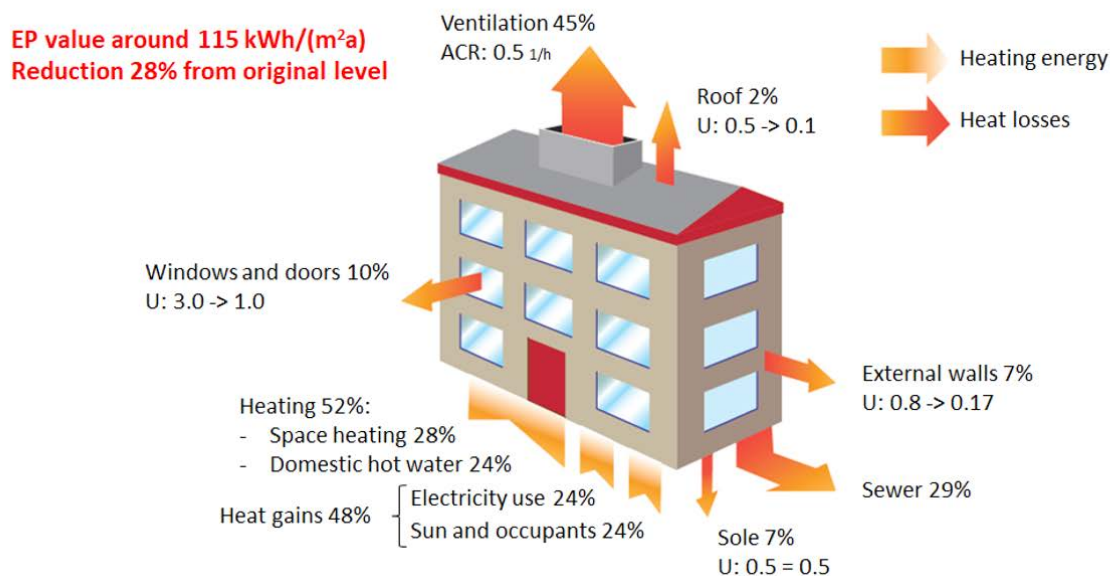


**Figure 1.** Example of energy balance of an apartment building before the renovation.

### Typical apartment building from the 1950s-1970s



Step I: Renovation of building envelope – Improved insulation and airtightness



**Figure 2.** Improving the U values of the building's outer shell, windows, doors, walls and roof reduces heating energy consumption by only 28%.



which account for losses of 29%. Since the building in question was already airtight under the original conditions and underpressurized with mechanical exhaust ventilation, renovating the outer shell did not bring any additional benefits in infiltration/air leakage losses.

### Airtightness

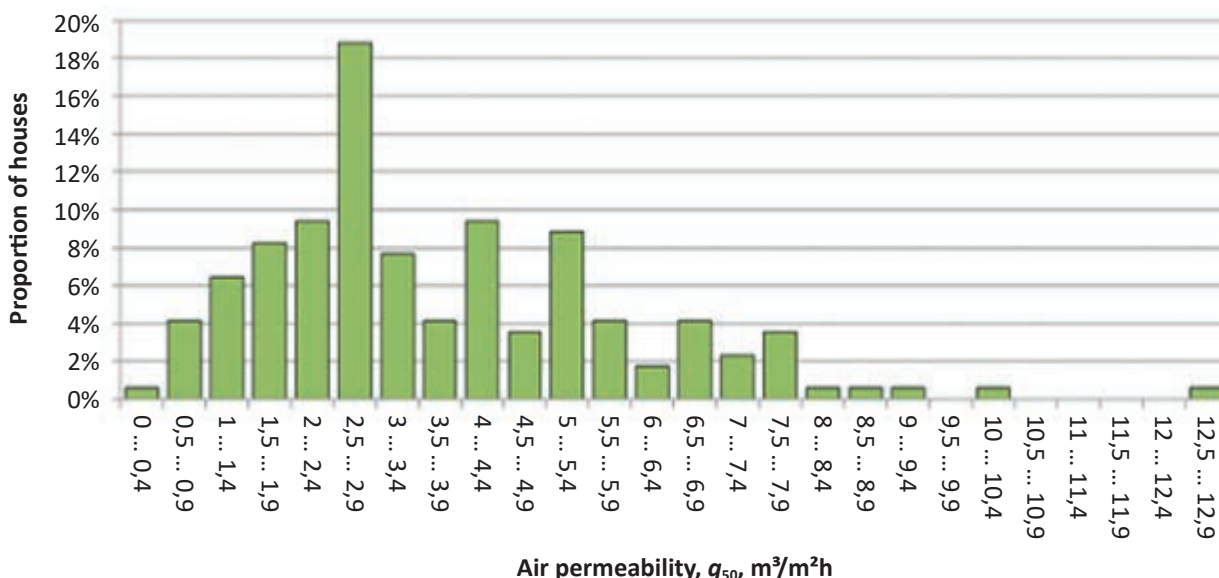
Often, the poor airtightness in old buildings and especially in single-family houses is a problem in more ways than one. In a Finnish building airtightness study, a wide dispersion came to the fore.

*Air permeability  $q_{50}$  = How many cubic meters of air ( $m^3$ ) flow through one square of the outer*

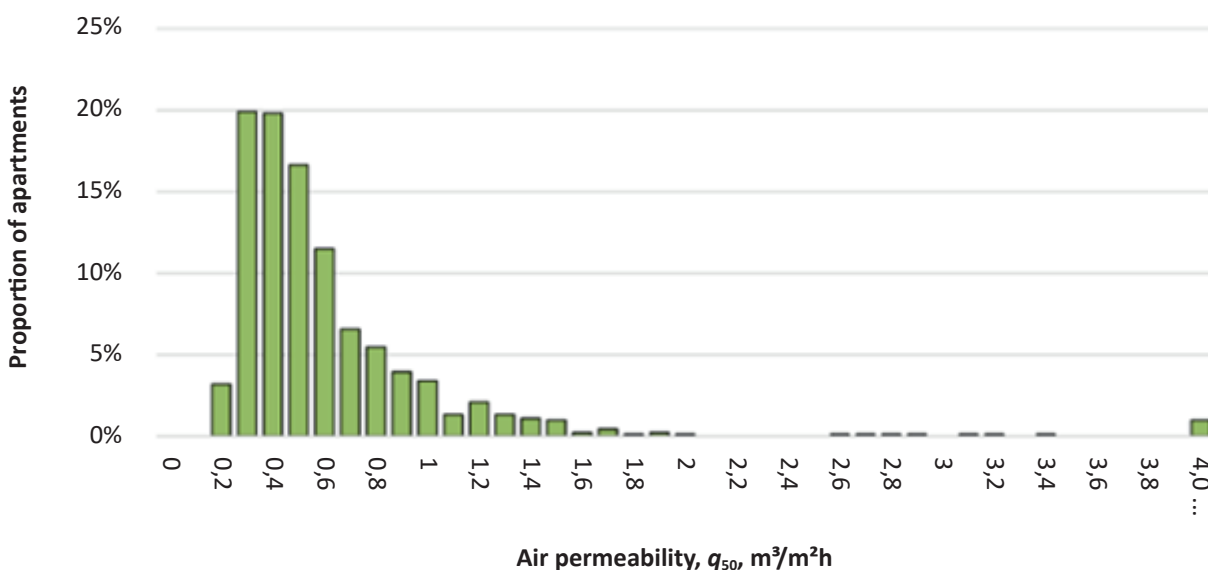
*shell ( $m^2$ ) per hour when the pressure difference is 50 pascals. The air permeability of a building is measured by the fan pressurization method, Blower door method. Infiltration airflow rate in  $m^3/h$  can be calculated as  $q_{50} \cdot A/20$  where  $A$  is the building envelope area in  $m^2$  including external floor.*

Air permeability  $q_{50}$  values in old detached houses, **Figure 3**, ranged from 0.5 to 12, with an average of  $3.7 m^3/m^2h$ .

Apartment buildings are clearly more airtight than detached houses. For example,  $q_{50}$  values of new apartment buildings, with an average of  $0.6 m^3/m^2h$ . **Figure 4**.



**Figure 3.**  $q_{50}$  values of old detached houses (1978-2006). (Vinha et al.)



**Figure 4.** Airtightness values of new apartment buildings (2014-2018). (Vinha et al.)



Airtightness	Air permeability, $q_{50}$ , $m^3/m^2h$	Infiltration losses, kWh/a	Cost per year, €, energy price 0.2 €/kWh	Costs in 20 years, €
Poor	8	5,200	1,040	20,800
Good	0.5	300	60	1,200

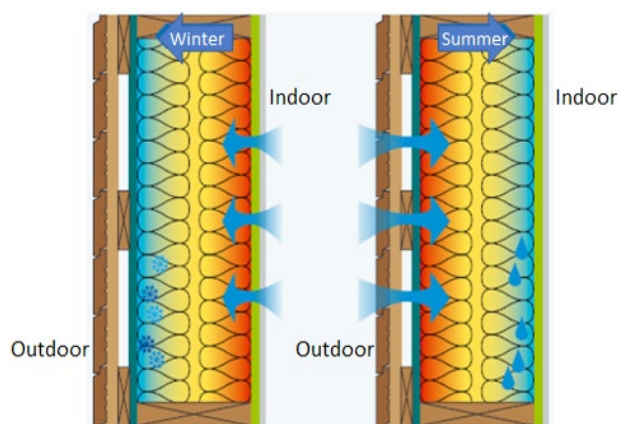
**Figure 5.** Airtightness has a significant impact on the energy costs of a typical detached house. Here, 0.20 €/kWh has been used as the price of heating energy. The difference can be up to €20,000 within 20 years.

If, for any reason, the thermal insulation of the exterior walls is not renewed during renovation, it is, for example, worthwhile improving the building’s airtightness in any case. The energy benefits obtained in this way can be achieved at significantly lower costs. **Figure 5** compares the energy costs of two typical Finnish single-family houses due to infiltration losses.

Air leaks in buildings cause additional energy costs, moisture condensation in structures, draughts as well as dust, microbes and radon entering the indoor air. Leaks can be located by thermal imaging, probing by hand, air flow measurements, smoke testing, tracer-gas method or acoustic methods. For an energy-efficient house, the airtightness  $q_{50}$  target should be 1.0  $m^3/m^2h$  or lower. This achieves an energy saving of about 20% compared to the airtightness  $q_{50}$  value of 4.0  $m^3/m^2h$ . Typical leak points are insufficient seals on windows and doors, seams on windows and door frames, seams on exterior walls and roofs, wall penetrations for electrical cabling and ventilation duct penetrations in the walls and ceiling. Defects in the moisture barrier/foil also cause air leakage.

### Condensation

A family of four produces 5–10 kilograms of water moisture in the air of the apartment. However, it does not all leave through ventilation, but tends to move through the structure in the direction of the outside air during winter. If the building envelope is not sufficiently air- and steam-tight (insulating film), the water humidity cools the insulating material and reaches the dew point temperature, whereupon the steam condenses into water. The wall structure must be after the moisture barrier breathable in the direction of the outside air so that the water can evaporate/dry



**Figure 6.** During winter, water vapor travels outwards in the cold direction in the structure. In summer, when indoor cooling is in use, water vapor travels inwards.

out. This prevents the growth of mould in structures. In the summer, when the outdoor temperature and humidity are high and air conditioning is in use, the condensation phenomenon in question occurs in the structure towards the inside, **Figure 6** that brought a need for a moisture barrier allowing humidity transfer at high relative humidity. Especially in demanding warm and humid climates, building structures must be able to transfer water moisture both towards the outside and inside.

### Conclusion

These examples demonstrate how important it is to improve air tightness and install heat recovery from exhaust air in deep renovations aiming at least to halve energy usage. ■

# Start breathing – future of non-residential buildings has started!

This article shows how primary energy consumption of non-residential buildings can significantly be reduced by the usage of the “breathing” principle. Further the article describes an award winning and innovative decentralized ventilation solution, that uses only one fan for both, supply and exhaust, to provide a constant, minimizing power consumption.



**Keywords:** breathing, decentralized ventilation, decentralized facade ventilation unit, EED, EPBD, GEG / Gebäudeenergiegesetz, ISO 7726, ISO 7730, non-residential buildings, recuperator, *SFP* (Specific Fan Power), thermal comfort

## Introduction

The global efforts made to reduce primary energy consumption are reflected in the many guidelines issued for minimizing the energy consumption of **non-residential buildings**. In Europe, the Energy Performance of Buildings Directive 2018/844/EU (**EPBD**) and the Energy Efficiency Directive 2012/27/EU (**EED**) are now shaping the future, since buildings account for approximately 40 percent of the EU’s energy consumption and 36 percent of CO<sub>2</sub> emissions in Europe. A “high-efficiency air-conditioning system that addresses the issues of healthy indoor climate conditions” must, on the one hand, transport a minimum quantity of outside air into users’ indoor rooms while using as little energy as possible to do so. On the other hand, it must have good heat recovery capabilities in order to minimize the energy used to cover the ventilation heating requirement. Regarding the EU regulation No. 1253/2014, thermal efficiency of the heat recovery system of non-residential ventilation units,  $\eta_{t,nrvu}$ , has to be 73% at a minimum. This heat recovery system has an air-side pressure loss which cannot be compensated for by natural ventilation. This will make fan-assisted mechanical ventilation indispensable in the future.

In Germany, as of the year 2000, the central ventilation system was substituted by small ventilation units mounted at a constant distance along the façade, which fulfil the same functions as a central ventilation system. Typical restrictions are limited dehumidification, no humidification and limited cooling capacity. The

elimination of construction spaces for the high-volume system of ductwork, the reduction of costs for conveying the air and the possibilities of on-demand ventilation are major advantages of decentralized air conditioning. On the other hand, there are large numbers of technical components, such as fans, dampers or filters which need service and maintenance and have been unable to meet the minimum heat recovery requirements, currently placed on non-residential buildings.

Therefore, it is necessary to present a “high-efficiency alternative system”, which is based on the decentralized ventilation concept and overcomes the main drawbacks of known systems. This innovative device concept, which makes use of a transient operating mode, is inspired by the breathing process. During test measurements, it was possible to identify energy consumption levels for air transportation and heat recovery values that have never before been observed at this order of magnitude. During the years 2015-2021, the technology was used in a number of construction undertakings and has proved its functional capabilities and energy efficiency in projects in which nearly 1,000 decentralized ventilation units “breathe” on the building facade in transient mode.

## Technical consideration of a transient ventilation system

The structures of a decentralized ventilation unit and central ventilation system are very similar. Thus, two

openings for outside air and exhaust air are required. These can both be hermetically closed by means of an adjustable motor-driven damper. Two fans provide the ventilation into the room and the exterior. Both must overcome the internal pressure loss of all the device components. Heat recovery is performed by means of a **recuperator**. When the conventional system construction is transferred to **decentralized ventilation** units, the external pressure losses are greatly reduced due to the omission of the ducting system in the building, including fire dampers and air diffusers.

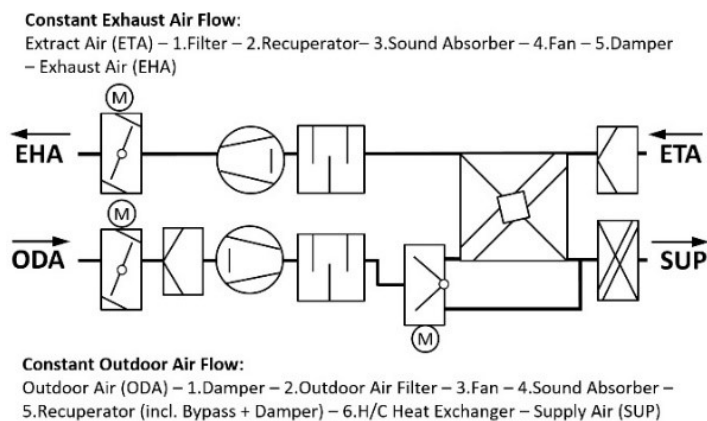
In the concept described here (**Figure 1b**) a single radial fan continuously conveys air, but with double the transient volume flow rate. A damping system consisting of four dampers intermittently switches the **airflow direction between outside and exhaust air mode, while the fan's rotation and transport direction remain unchanged**. The bionic transfer of this

intermittent ventilation concept from nature has its origins in the breathing process.

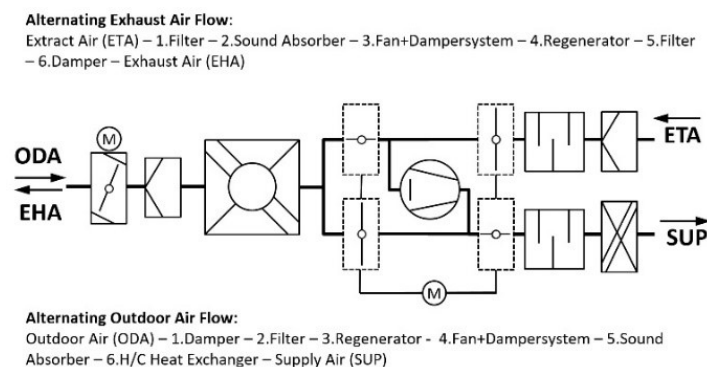
The airflow components are arranged in such a way that there is a single airflow path on the “facade side” of the group of dampers. This airflow path contains a single outside air damper, a fine filter, the heat recovery unit and an opening in the facade. This air route is intermittently exposed to outside air (ODA) and exhaust air (EHA). On the “room side” of the group of dampers, there are separate air routes for supply air (SUP) and extract air (ETA).

To avoid pressure differences between adjacent rooms caused by this transient ventilation system, two units can be interconnected simultaneously.

Summing up, this new ventilation system provides many new features: regenerative heat recovery, transient air flow inside the room, calculation of the thermal comfort in transient conditions and the design of the supply air temperature.



**Figure 1a.** Structure of a decentralized ventilation unit with continuous functions: outside air feed, extract air removal, heating, cooling and heat recovery;



**Figure 1b.** Structure of a decentralized ventilation unit with transient operating mode and with cyclically alternating functions: outside air feed, extract air removal, heating, cooling and heat recovery.

### Electrical energy consumption

The electrical consumption required for transporting the air into and out of the building is a major consideration towards the primary energy requirement of buildings, without reducing the Indoor Air Quality. In the case of a decentralized ventilation unit, this means minimizing the power consumption.

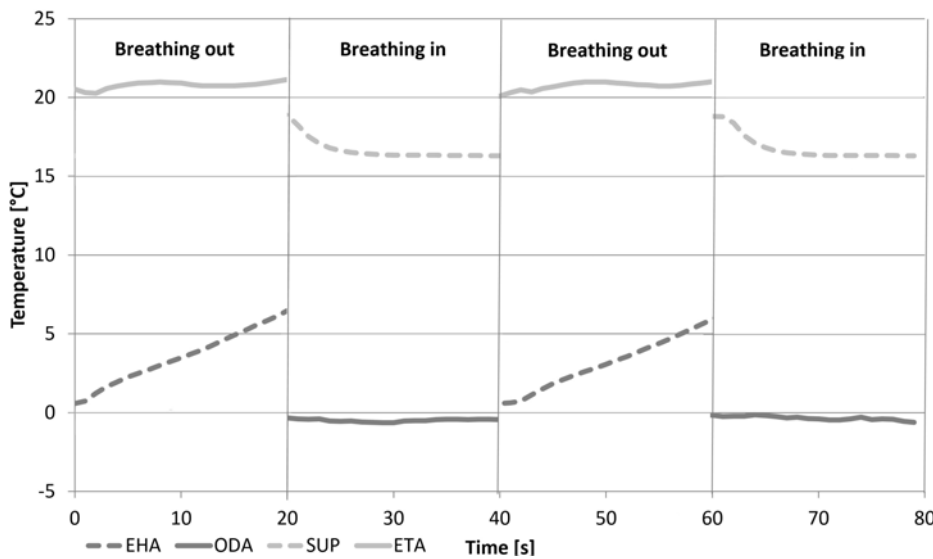
An important fact, as the European standards limit the permitted value for building ventilation in the new-build sector to the class *SFP-4*. Known decentralized ventilation units with a conventional design with two fans achieve considerably better values, irrespective of the acoustic emissions.

Measurements show that, at a conveyed volume flow rate of 120 m<sup>3</sup>/h (33.3 l/s), each of the two radial fans has a power consumption of 16 W. The *SFP<sub>decentralvalue</sub>* is therefore *SFP<sub>decentral</sub>* = 480 Ws/m<sup>3</sup>. Replacing two fans with one fan, that is operated with twice the volume flow rate, namely *q* = 240 m<sup>3</sup>/h (66.6 l/s), leads to a higher power requirement than in the first approach. In a building, in which the units are operated at an average of 90 m<sup>3</sup>/h (25 l/s), this means power consumption per fan of < 10 W for each unit. The corresponding *SFP* value is 194 Ws/m<sup>3</sup>. To show the resulting energy saving potential for air transport, a comparison of the *SFP* values is useful. For non-residential buildings, for example, the law in Germany “*Gesetz zur Vereinheitlichung des Energieeinsparrechts für Gebäude*”

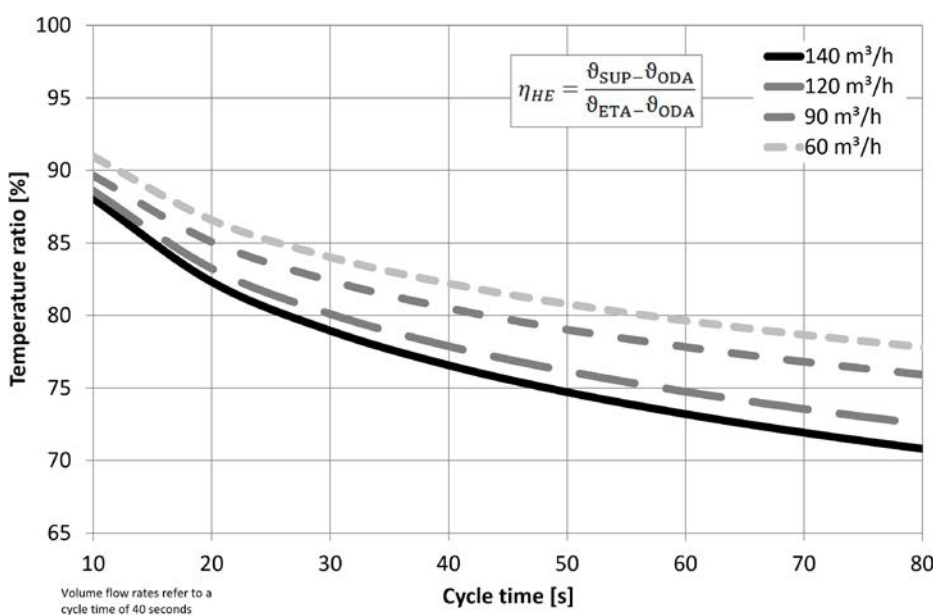
(2020) requires a minimum *SFP* of 1500 Ws/m<sup>3</sup> for supply air and 1000 Ws/m<sup>3</sup> for exhaust air. The average value of 1250 Ws/m<sup>3</sup> can now be compared with the *SFP* value of the described transient system at an average volume flow of 90 m<sup>3</sup>/h (25 l/s). The power requirement for the air transport through the building is **therefore only 15.52% of the required minimum value**. This represents a guaranteed compliance with the European Standards and also a huge energy saving potential for the non-residential buildings sector.

### Regenerative heat recovery

A second aspect in minimizing the primary energy requirement consists in efficient heat recovery. Energy costs can be reduced by minimizing the ventilation heating requirement during the winter. In case of continuous operation, heat recovery is performed using a recuperator. The regenerator acts as a heat store and is alternately loaded and unloaded. Temperature ratios of up to 90% can be reached with this system (Kaup 2009, Mathis 2019).



**Figure 2a.** Temperature curves in a unit with regenerative heat recovery and a cycle time of 40 seconds; the interval between the extract and exhaust air temperature on “breathing out” and the supply and outside air temperature on “breathing in” is proportional to the amount of heat transferred.



**Figure 2b.** Temperature ratio in a regeneratively operated heat recovery unit, measured based on DIN EN 308 (1997). The optimum temperature ratio can therefore be set continuously at every operating point.

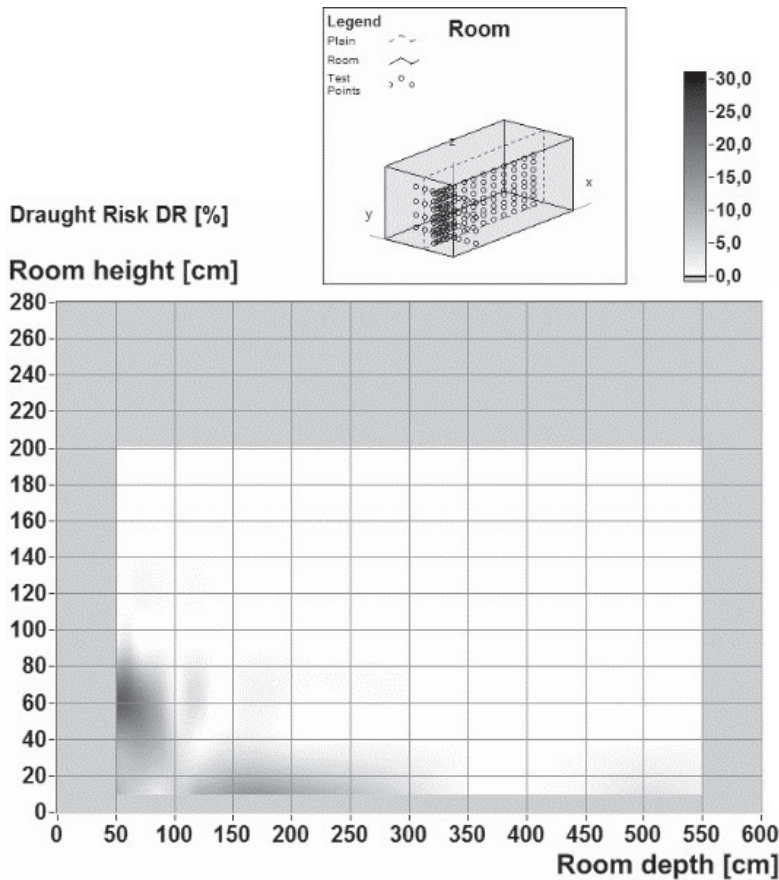
Dimensioning of the switchover heat recovery unit is an optimization process in which heat storage capacity, heat transfer coefficient and thermal diffusivity have to be maximized at a limited volume without increasing pressure loss and the associated acoustic emissions from the fan. **Figure 2a** shows the air temperatures of a decentralized ventilation unit with integrated regenerator, measured using thermocouples with a very short response time of  $t_{90}=15$  seconds. Each cycle is subdivided into the sub-cycles “breathing in” and “breathing out”. On the “breathing in” sub-cycle, fresh air is conveyed into the room, and on the “breathing out” sub-cycle, used air is conveyed out of it. The diagram shown in **Figure 2b** makes it clear, that the temperature ratio has to decline as the cycle time increases, because of the average temperature difference between extract air and exhaust air.

### Thermal comfort

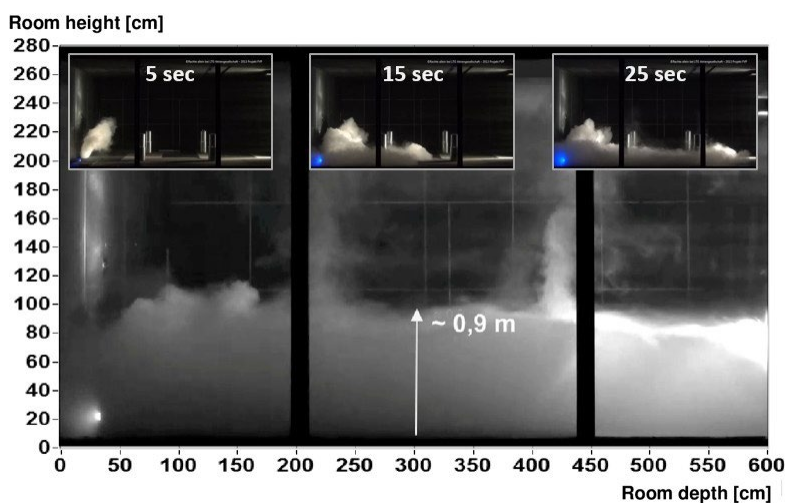
For the measurement, recording, judgment and evaluation of **thermal comfort** the international standards **ISO 7726** (1998) and **7730** (2006) are authoritative. Measurements of thermal comfort were conducted in a test chamber with a typical office layout. In this setup, internal heat gains and a temperature-controlled facade



were used in order to create steady state conditions for cooling and heating cases.



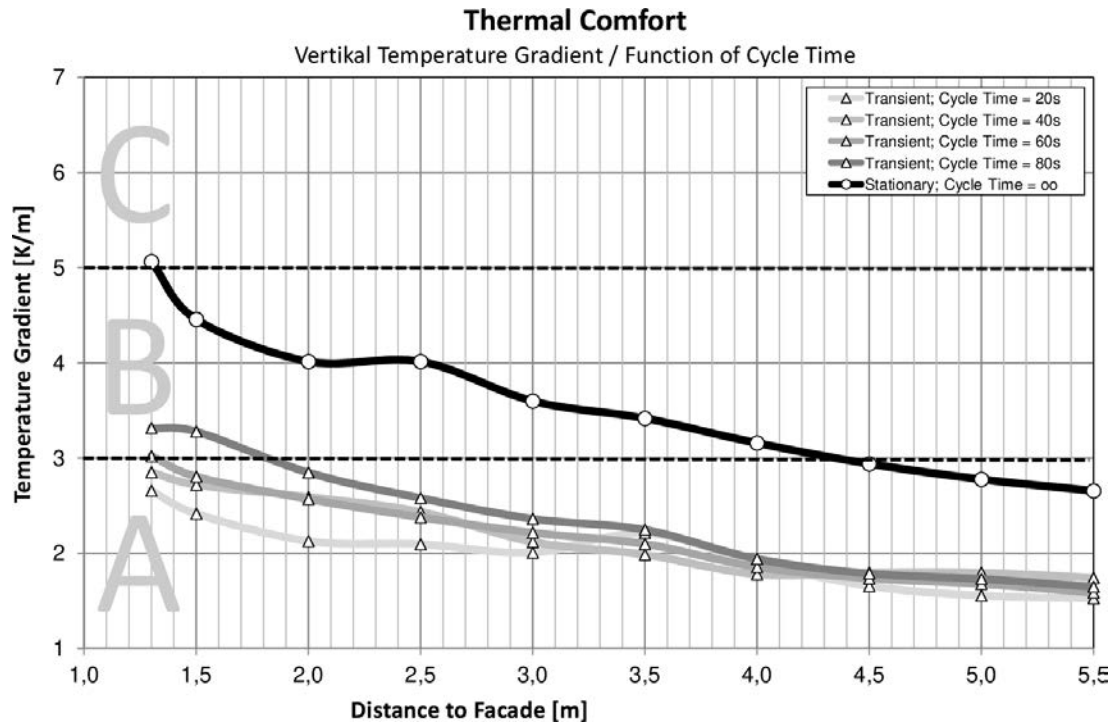
**Figure 3a.** Distribution of the local risk of draft; facade at  $x = 0$ ; risk of draft as per ISO 7730 in the case of cooling; comfort criteria for a sitting person with light summer clothing; humidity = 70%; under-temperature of the supply air compared to the room air = 8 K; cycle time 40 seconds.



**Figure 3b.** Visualization of the airflow pattern. The height of the cooled air volume is approximately 0.9 m at a supply air under temperature of 8 K, highly inductive supply air after 5, 15 and 25 seconds.

**Figure 3a** shows the risk of drafts that occurs in the case of floor-level air inflow by means of an underfloor unit. The Figure shows a section through an office room perpendicular to the facade. Even at a distance of 20 cm from the outlet grille, category B of ISO 7730 is complied with. The air is now warmer and forms layers up to a greater height in the room. Instead of a lower pool of fresh air, that is typical for displacement ventilation, a larger volume is now supplied with cool, fresh air. The height of the cooled air volume in the case of a steady state experiment and a supply air volume of  $120 \text{ m}^3/\text{h}$  is 0.5 m, for a transient test, the height increases to 0.9 m for cycle times of 40, 60 and 80 seconds. As can be seen in **Figure 3b**, almost the entire space taken up by a sitting person is covered. As a result, a smaller vertical temperature gradient occurs in the frequented area (**Figure 4**). This more uniform temperature distribution makes it possible to allow greater room set temperature tolerances in the control system.

The cooling capacity that is introduced in a thermally comfortable way into the occupied area increases. An indication for the additional induction is the mixing of the cold supply air with the warm air in a larger volume and therefore the reduction of the temperature gradient (in **Figure 4**). It is found that, the temperature gradient in the entire frequented area falls off continuously as the length of the period becomes shorter (**Figure 4**). It can be seen that through the period length factor, the transient operating mode creates an additional degree of freedom for controlling the mixing of the supply air and room air.



**Figure 4.** Vertical temperature gradient according to ISO 7730 (1.1 m – 0.1 m) as a function of the cycle time and the distance to the facade and ventilation unit. The volume flow rate is 120 m<sup>3</sup>/h, the under temperature of the supply air against the extracted air is –6.5K.



### Application

For the first “breathing” office building worldwide, 115 decentralized facade ventilation units including the appropriate facade opening were installed (**Figure 5**).

### Conclusion

It has been shown that the ventilation and air conditioning of non-residential buildings using decentralized room-by-room ventilation units offers great potential in terms of reducing the primary energy requirement. A transient operating principle improves energy efficiency by minimizing power consumption for



**Figure 5.** Application of decentralized ventilation unit; Opening in the facade (left). Decentralized devices in the room (above).

conveying the air and, by using a regenerator, makes it possible to minimize the ventilation heat requirement thanks to the controllable heat recovery with

temperature ratios of up to 90%. Thermal comfort in the frequented area is ensured thanks to the high level of inductivity of the supply air jets. ■

### Symbols

$SFP$	= specific fan power [ $Ws/m^3$ ]
$q$	= volume flow rate [ $m^3/h$ ]
$\eta$	= efficiency [-]
$\eta_{t,nrvu}$	= minimum thermal efficiency [-]

### Subscripts

ODA	= outdoor air
SUP	= supply air
IDA	= indoor air
ETA	= extract air
EHA	= exhaust air
IAQ	= Indoor Air Quality

### References

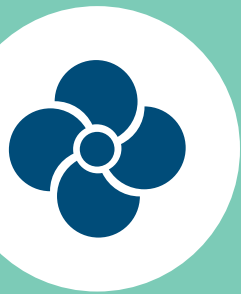
- COMMISSION REGULATION (EU) No 1253/2014 of 7 July 2014 implementing Directive 2009/125/EC of the European Parliament and of the Council with regard to ecodesign requirements for ventilation units.
- DIRECTIVE (EU) 2018/844 OF THE EUROPEAN PARLIAMENT AND OF THE COUNCIL of 30 May 2018 amending Directive 2010/31/EU on the energy performance of buildings and Directive 2012/27/EU on energy efficiency.
- DIRECTIVE 2012/27/EU OF THE EUROPEAN PARLIAMENT AND OF THE COUNCIL of 25 October 2012 on energy efficiency, amending Directives 2009/125/EC and 2010/30/EU and repealing Directives 2004/8/EC and 2006/32/EC.
- EN 308. 1997. Heat exchangers - Test procedures for establishing performance of air to air and flue gases heat recovery devices.
- Geiger, M. 2013. Beurteilung der thermischen Behaglichkeit bei instationärer Raumluftströmung. Bachelor Thesis, HS Esslingen.
- Gesetz zur Vereinheitlichung des Energieeinsparrechts für Gebäude und zur Änderung weiterer Gesetze von 8 August 2020. 2020. Bundesgesetzblatt Jahrgang 2020 Teil I Nr. 37.
- ISO 7726. 1998. Ergonomics of the thermal environment - Instruments for measuring physical quantities.
- ISO 7730. 2006. Ergonomics of the thermal environment - Analytical determination and interpretation of thermal comfort using calculation of the PMV and PPD indices and local thermal comfort criteria.
- Kaup, C. 2009. Raumlüftung mit Hochleistungs-Wärmerückgewinnung. HLH.
- Kriegel, M., E. Lichtner, N. Schultz. 2017. Instationäre Quelllüftung. Technische Universität Berlin.
- Mathis, P., T. Röder, B. Klein, T. Hartmann, C. Knaus. 2019. EwWalt Study – Energetische Bewertung der dezentralen kontrollierten Wohnraumlüftung in alternierender Betriebsweise. FGK-Report.
- Melikov, A. 2010. Thermal Comfort. Local Thermal Discomfort. Lecture held at Czech Technical University in Prague.
- Ring, J.W., R. de Dear, A. Melikov. 1993. Human thermal sensation: frequency response to sinusoidal stimuli at the surface of the skin. Energy and Buildings, 20: 159-165.



## CERTIFICATION PROGRAMMES

FOR DOMESTIC, COMMERCIAL AND INDUSTRIAL FACILITIES

### VENTILATION & AIR QUALITY



- Air purifiers\*
- Air filters\*
- Air handling units\*
- Air handling units - Hygienic
- Chimneys
- Residential ventilation
- Fans
- Humidity-controlled ventilation
- Indoor air quality and energy efficiency of ventilation systems
- Plate heat exchangers\*
- Residential air filters
- Residential air handling units
- Rotary heat exchangers\*
- Air ducts

### INDOOR CLIMATE



- Air conditioners\*
- Chilled beams\*
- Comfort chillers
- Stoves & Barbecues
- Domestic solar water heaters
- Fan coil units
- Heat interface units\*
- Heat pumps
- Hybrid heat pumps
- Liquid-to-liquid plate heat exchangers
- Micro combined heat and power
- Mobile heaters
- Radiators
- Rooftop units\*
- Solar systems
- Thermostatic valves - Temporal value
- Thermostatic valves
- Variable refrigerant flow systems\*

### PROCESS COOLING & FOOD COLD CHAIN



- Condensing units
- Cooling and heating coils
- Cooling towers
- Drift eliminators
- Evaporative cooling
- Heat exchangers
- IT cooling units\*
- Process chillers\*
- Refrigerated display cabinets
- Twin coils heat exchangers

\*All models in the production must be certified: Certify-all principle



## AIR PURIFIER\*

### SCOPE OF CERTIFICATION

The scope of this new certification programme includes devices for collecting and/or destroying indoor air pollutants for residential or tertiary sector applications, such as:

- Devices equipped with a fan that circulates an air flow of between 15 m<sup>3</sup>/h and 1,000 m<sup>3</sup>/h
- Independent electrically-powered devices.
- Residential (domestic) and tertiary sector applications: bedrooms, living rooms, offices, waiting rooms, retail stores, etc.
- All types of technology: mechanical filtration, electrostatic filtration, plasma, ionization, UV-A or UV-C lamp, etc.

### MAIN CERTIFIED CHARACTERISTICS & ACCEPTANCE CRITERIA

#### At maximum operating speed:

- Purification efficiency: purified air volume flow rate for each pollutant category treated such as
  - Breathable particles suspended in the air
  - Gaseous pollutants (formaldehyde, toluene, etc.)
  - Microorganisms (bacteria and mould)
  - Cat allergen
- Energy efficiency: (purified air volume flow rate / absorbed electrical power).
- Recommended room area for each pollutant category.

#### At 1, 2 or 3 operating speeds:

- Device air circulation flow rate.
- **Energy:** absorbed electrical power.
- **Noise impact:** sound power level.

**When tested in the laboratory the obtained performance data shall not differ from the declared values by more than the following tolerance values:**

- Air circulation flow rate [m<sup>3</sup>/h]: -5%
- Initial purified air flow rate [m<sup>3</sup>/h]: -5%
- Sound power level [dB(A)]: +2 dB(A)
- Absorbed electrical power [W]: Maximum [+5%; +1 W].

### ECC REFERENCE DOCUMENTS

- Certification manual
- Technical Certification Rules ECP -20
- NF-536.

### TESTING STANDARDS

- NF B44-200:2016
- XP-B44-013:2009 may notably be used as a supplement in some particular cases identified in the NF-536 reference document.

## AIR FILTERS\*

CERTIFY ALL



### SCOPE OF CERTIFICATION

- This Certification Programme applies to air filters elements rated and sold as ISO ePM1, ISO ePM2.5 and ISO ePM10 according to EN ISO 16890-1:2016 referring to a front frame size of 592x592mm according to standard EN 15805.
- When a company joins the programme, all relevant air filter elements shall be certified.

### CERTIFICATION REQUIREMENTS

- For the admission procedures: 6 units will be selected and tested by an independent Laboratory selected by Eurovent Certification.

Then each year 4 units will be selected & tested

### CERTIFIED CHARACTERISTICS & ACCEPTANCE CRITERIA

- Filter ISO class rating: no tolerance.
- Initial pressure drop: +10% + 5 Pa (minimum 15 Pa)
- ePM1, ePM1,min, ePM2.5, ePM2.5,min and ePM10 efficiencies: -7%-point
- Annual energy consumption +10% +60 kWh/a.



### ECC REFERENCE DOCUMENTS

- Certification manual
- Technical Certification Rules ECP -11.

### TESTING STANDARDS

- EN ISO 16890: 2016
- Eurovent 4/21.



## AIR HANDLING UNITS\*

CERTIFY ALL



Swegon has participated in the program for Air Handling Units from the start.(...) Customers should go for Eurovent certified products, to get reliable data, and then they can cut the main cost and take care of the environment by minimising the use of energy.

**Mr. Gunnar Berg**  
Development Engineer, Swegon



### CERTIFIED CHARACTERISTICS & ACCEPTANCE CRITERIA

- External STATIC Pressure: 4% or 15 Pa
- Absorbed motor power: 3%
- Heat recovery efficiency: 3%-points
- Heat recovery pressure drop (air side): max. of 10% or 15 Pa
- Water coil performances (heating/cooling): 2%
- Water coil pressure drop (water side): max. of 10% or 2 kPa
- Radiated sound power level casing: 3 dB(A)
- Sound power level unit openings:
  - 5 dB @ 125 Hz
  - 3 dB @ 250 – 8 000 Hz
- Casing Air Leakage: same class or higher.

### SCOPE OF CERTIFICATION

This Certification Programme applies to all ranges of Air Handling Units that can be selected in a software. Each declared range shall at least present one size with a rated air volume flow below 3 m<sup>3</sup>/s. For each declared range, all Real Unit Sizes available in the software and up to the maximum stated air flow and all Model Box configurations shall be declared. Participants shall certify all models in the selected product range up to the maximum stated air flow. All ranges to be certified shall include at least one size with a rated air volume flow up to 3 m<sup>3</sup>/s.

### CERTIFICATION REQUIREMENTS

For the admission procedure: the selection software will be verified by our internal auditor. A visit on production site will be organized. During that visit, the auditor will select one real unit per range. The selected units will be tested and performances delivered by the selection software will be compared to the performances measured in an independent laboratory. For the surveillance procedures, the auditor will annually check the software conformity against the production data, and tests will be repeated every 3 years for the real unit and 6 years for the model box.

### ENERGY EFFICIENCY LABELLING

- Energy efficiency class for winter application
- **New!** Energy efficiency class for summer application.

### ECC REFERENCE DOCUMENTS

- Certification manual
- Technical Certification Rules ECP -05.

### TESTING STANDARDS

- EN 1886: "Ventilation for buildings – Air handling units – Mechanical performance"
- EN 13053: "Ventilation for buildings – Air handling units – Rating & performance for units, components and sections"
- Appendix H of ECP-05 AHU for HAHU.

## AIR HANDLING UNITS - HYGIENIC

### SCOPE OF CERTIFICATION

This programme applies to hygienic ranges of Air Handling Units. As an option of the Certification programme for Air Handling Units, only an already ECP certified range is eligible for the hygienic option. The hygienic aspect of the AHU is certified based on a 3 levels classification, each level declaring an AHU suitable for different application:

- **Level 1:** Offices, commercial buildings, schools, hotels
- **Level 2:** Hospitals
- **Level 3:** Pharmaceutical, food processes, white rooms

The previous list is not exhaustive and must be used as a reference only. Final customer/user who has complete and detailed knowledge of the building application shall decide which Hygienic rating level is appropriate.

### CERTIFICATION REQUIREMENTS

Same as in the Air Handling Unit programme.

### CERTIFICATION CHARACTERISTICS & ACCEPTANCE CRITERIA

#### Services characteristics:

The following services characteristics are certified:

1. Manufacturing
2. Maintenance
3. Quality Management System

4. IOM (Installation and Operational Manual)
5. Shipment.

#### Hygienic characteristics:

The following hygienic characteristics are certified:

1. Materials
2. Casing performance
3. Components arrangement and performances (filters, coils, heat recovery systems, fans, humidifiers, dehumidifiers and silencers).

### ECC REFERENCE DOCUMENTS

- Certification manual
- Technical certification rule ECP-5
- Appendix H of ECP-05 AHU for HAHU.

### TESTING STANDARDS

- Appendix H of ECP-05 AHU for HAHU
- EN ISO 846:1997
- EN ISO 2896:2001
- EN 10088-3:2014
- EN 1993-1-2:2005
- DIN 1946/4-6.5.1:2008
- EN 779:2012
- EN 1822:2010
- EN ISO 12944-2:1998.

## FANS



### SCOPE OF CERTIFICATION

This certification programme applies to the fans types that are intended to be used as Air Handling Units components.

### CERTIFICATION REQUIREMENTS

The certification scheme is based on product performance testing by independent testing laboratories as well as manufacturing facility auditing and selection software checking.

Two sub-programmes enable distinguishing performances certified for an impeller basic assembly on the one hand (sub-programme FAN-I) and for a complete assembly on the other hand (sub-programme FAN-C).

In both cases, the fan assembly is evaluated in accordance with a wire-to-air approach. This approach consists in assessing the fan performance from the electric wire to the air discharge, accounting for all the components involved in the air stream generation that affect the performance data.

- For admission and surveillance procedure, two regular tests per range shall be selected during the audits to cover the variations declared (see OM IV.2. and range definition in RS/1/C/001).
- On top of this selection, the applicant shall provide to Eurovent Certita Certification the appropriate number of test reports (see OM Appendix C).

The performances measured by the independent laboratory (or available in the reports) are compared to the selection software output data.

### CERTIFIED CHARACTERISTICS & ACCEPTANCE CRITERIA

Performance items	Tolerance value
Static pressure difference	-4 % or -15 Pa
Motor (electrical) input power	+3 %
Drive/control (electrical) input power	+3 %
Overall (static) efficiency	-5 percentage points
Inlet and outlet sound power level LWfc by octave bands at 125 Hz	+5 dB
Inlet and outlet sound power level LWfc by octave bands between 250 Hz and 8000 Hz	+3 dB

### ECC REFERENCE DOCUMENTS

- Certification manual
- Operational manual OM-22
- Rating standard RS 1/C/001.

### TESTING STANDARDS

- ISO 5801:2007
- ISO 13347-2:2004.



# INDOOR AIR QUALITY AND ENERGY EFFICIENCY OF VENTILATION SYSTEMS

## SCOPE OF THE PROGRAMME

The IAQVS programme scope covers mechanical ventilation systems for single-family homes and apartments.

The categories of ventilation systems covered by the scope are the following:

- Central, single flow (supply or exhaust) without heat recovery
- Central, double flow (balanced ventilation) with or without heat recovery
- Single-room, single flow (decentralised continuous ventilation for supply or exhaust)
- Single-room, double flow (balanced ventilation) with or without heat recovery

## CERTIFICATION CHARACTERISTICS & ACCEPTANCE CRITERIA

The IAQVS programme is intended to certify the performance of an assembly of ventilation components forming a specific ventilation system. The performances are evaluated considering the whole assembly, which enables to assess the synergies between its constituting components.

The ventilation system is evaluated through simulations in consistency with its application field. The simulations provide performance indicators that enable to assess the ventilation

system performance from both Indoor Air Quality and Energy Efficiency perspectives.

### Indoor Air Quality indicators

A global Indoor Air Quality indicator (IIAQ) is defined as the average of the following indicators:

- Carbon dioxide (CO<sub>2</sub>) concentration indicator (ICO<sub>2</sub>) which represents air stuffiness
- Air Relative Humidity (RH) indicator (IH<sub>2</sub>O) which represents the excess/lack of humidity in the air
- Formaldehyde concentration indicator (IFOR) which represents the chemical pollution emitted by furniture and construction materials
- The IAQ indicators are expressed by individual grades from 0 (bad Indoor Air Quality) to 5 (good Indoor Air Quality). They are rounded to one decimal place.

### Energy Efficiency indicators

The following Energy performance indicators are assessed:

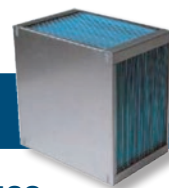
- Energy consumption of the fan (Efan)
- Consumption induced by air renewal (Eheating)

They are expressed in kWh/annum (rounded to the nearest integer).

All these indicators are represented in a label specific to each ventilation system.

## PLATE HEAT EXCHANGERS\*

CERTIFY ALL



### SCOPE OF CERTIFICATION

This Certification programme applies to selected ranges of Air to Air Plate Heat Exchangers. Participants shall certify all models in the selected range, including:

- cross flow, counter-flow and parallel flow units
- all sizes
- all materials
- all airflow rates
- all edge lengths
- plate heat exchanger with humidity transfer

Heat Exchangers with accessories such as bypass and dampers shall not be included.

Manufacturers shall declare production places and provenance of products is randomly chosen. The programme does not cover other types of Air to Air Heat Exchangers like Rotary Heat Exchangers or Heat Pipes. Combination of units (twin exchangers) are also included in the scope of the programme.

### CERTIFICATION REQUIREMENTS

For each range to be certified, 3 units for admission and 1 for yearly surveillance will be selected by Eurovent Certita Certification and tested in an independent Laboratory.

### CERTIFIED CHARACTERISTICS & ACCEPTANCE CRITERIA

- Dimensions:  $\pm 2$  mm
- Plate spacing:  $\pm 1\%$  or  $\pm 1$  plate
- Temperature efficiency Dry:  $-3$  percentage points
- Temperature efficiency Wet:  $-5$  percentage points
- Humidity efficiency:  $-5\%$
- Pressure drop:  $+10\%$ , minimum 15 Pa.

### ECC REFERENCE DOCUMENTS

- Certification manual
- Technical Certification Rules ECP -08.

### TESTING STANDARDS

- EN 308.



## RESIDENTIAL AIR FILTERS

### SCOPE OF CERTIFICATION

The programme scope covers the particulate and combination (particulate and gas) filters used in a residential ventilation unit and for which the following applies:

- the rated maximum air flow rate is comprised between 70 and 1000 m<sup>3</sup>/h included;
- the initial efficiency ePM10 is higher than or equal to 50%;
- the initial efficiency ePM1 is strictly lower than 99%;
- the ratio between effluent and influent concentrations measured at time zero is strictly lower than 20% (for combination filters only, see Rating Standard RS/4/C/003 for further details).

The programme scope covers filters for which the face area is lower than or equal to 300 mm x 600 mm. For the RFL programme, the certify-all requirement as defined in the Certification Manual is applicable from January 1<sup>st</sup> of 2020 (see Operational Manual OM-21 for further details).

### CERTIFIED CHARACTERISTICS & ACCEPTANCE CRITERIA

When tested in the laboratory the obtained performance data shall not differ from the declared values by more than the following tolerance values:

- **Initial pressure drop values:** +10%+Mt or +10 Pa +Mt
- **Initial efficiency values:** -5 percentage points (absolute deviation)
- **Minimum efficiency values:** -5 percentage points (absolute deviation)
- **Filter ISO ePMx class reporting value:** -5 percentage points (absolute deviation)
- **Adsorption capacity:** -10%.

Nota : Mt means "measuring tolerance"

### ECC REFERENCE DOCUMENTS

- Certification manual
- Operational manual OM-21
- Rating standard RS/4/C/003.

### TESTING STANDARDS

- Eurovent 4/22:2015 (particulate filters and combination filters)
- SO 11155-2:2009 (combination filters only).

## RESIDENTIAL AIR HANDLING UNITS

CERTIFY ALL



For us, as a manufacturer, it pays to develop good products that deliver what we promise. By utilizing certified products, the designers' task is easier as they do not need to make detailed comparisons or perform advanced tests. Consultants, engineers and users can select a product and be assured that the catalog data is accurate.

**Mr. Tobias Sagström**  
Global Product Manager Residential at Systemair AB

### SCOPE OF CERTIFICATION

This programme applies to balanced residential AHUs (supply and exhaust) with heat recovery systems such as:

- Air-to-air **plate** heat exchangers
- Air-to-air **rotary** heat exchangers
- **Heat-pumps** with a nominal airflow below 1 000 m<sup>3</sup>/h.

### CERTIFICATION REQUIREMENTS

- Admission test campaign: 1 test per heat recovery type.
- Surveillance test campaign: 1 test every 2 years for each heat recovery type.
- Units are sampled directly from selling points.

### CERTIFIED PERFORMANCES

- Leakage class
- Aeraulic performances:
- Airflow/pressure curves
- Maximum airflow [m<sup>3</sup>/h]
- Electrical consumption [W]
- Specific Power Input SPI [W/(m<sup>3</sup>/h)]
- Temperature efficiency / COP
- Performances at cold climate conditions
- SEC (Specific Energy Consumption) in [kWh/(m<sup>2</sup>.an)]
- A-weighted global sound power levels [dB(A)] .

### ACCEPTANCE CRITERIA

- Leakage class 0
- Airflow -10%
- Temperature efficiency -3%-point
- Temperature efficiency at cold climate -6%-point
- COP / EER -8%
- A-weighted global sound power levels +2dB(A)
- Electrical consumption +7%
- Specific Power Input SPI +7%
- Disbalance ratio 0.

### ECC REFERENCE DOCUMENTS

- Certification manual • TCR ECP -10.

### TESTING STANDARDS

- European standard EN 13141-7:2010.



CERTIFY ALL

## ROTARY HEAT EXCHANGERS\*

### SCOPE OF CERTIFICATION

This Certification Programme applies to all ranges of Air to Air Regenerative Heat Exchangers (RHE) including sealing systems. Units sold without casing and sealing systems are also included. Participants shall certify all models in the ranges, including:

- all classes: condensation (non-hygroscopic, nonenthalpy) RHE, hygroscopic enthalpy RHE, hygroscopic sorption RHE
- all RHE geometry (wave height, foil thickness)
- all sizes (rotor diameters and rotor depths and surface areas of Alternating Storage Matrices - ASM)
- all materials
- all airflow rates
- all different types of sealing (if available).

### CERTIFICATION REQUIREMENTS

For the admission procedures 1 unit per class of rotor will be selected and tested by an independent laboratory. For yearly surveillance, 1 unit will be selected.

### CERTIFIED CHARACTERISTICS & ACCEPTANCE CRITERIA

- Temperature Efficiency: -3% points
- Humidity Efficiency: -5% points (min. tolerance 0.2 g/kg in absolute humidity of leaving supply air)
- Pressure Drop: +10% (min 10 Pa)
- Outdoor Air Correction Factor (OACF): 0.05
- Exhaust Air Transfer Ratio (EATR): +1% point.

### ECC REFERENCE DOCUMENTS

- Certification manual
- TCR ECP-10.

### TESTING STANDARDS

- EN 308.

## AIR DUCTS

### SCOPE OF CERTIFICATION

The programme scope covers rigid and semirigid ventilation ductwork systems divided into the following sub-programmes:

- Rigid metallic ductwork systems with circular cross-section (DUCT-MC);
- Rigid metallic ductwork systems with rectangular cross-section (DUCT-MR);
- Semi-rigid non-metallic ductwork systems predominantly made of plastics (DUCT-P)

Each sub-programme applies to ductwork systems fitted with integrated sealing solution as described in relevant Rating Standard.

### CERTIFICATION REQUIREMENTS

The certification programme is based on product performance testing by independent testing laboratories as well as production sites auditing.

### CERTIFIED CHARACTERISTICS & ACCEPTANCE CRITERIA

The product performance testing will enable the verification of the following ratings accuracy:

- Air tightness class (all sub-programmes)
- Positive and negative pressure limits (all sub-programmes)
- Dimensions (DUCT-MC and DUCT-MR)
- Minimum and maximum service temperatures (DUCT-P)
- Resistance to external pressure (DUCT-P).

### ECC REFERENCE DOCUMENTS

- Certification manual
- Technical Certification Rules ECP -19.

### TESTING STANDARDS

- Air leakage and strength testing:
  - EN 12237:2003 (DUCT-MC)
  - EN 1507:2006 (DUCT-MR)
  - EN 17192:2018 (DUCT-P) – New in 2020

Service temperature and resistance to external pressure

- (DUCT-P):
  - RS 2/C/004P and EN 17192:2018 – New in 2020.





## AIR CONDITIONERS

CERTIFY ALL



### SCOPE OF CERTIFICATION

This certification programme includes:

- **AC1:** comfort air cooled AC and air to air HP with cooling capacity up to 12 kW, except double duct and single duct units.
- **AC2:** comfort units with cooling capacity from 12 to 50 kW
- **AC3:** comfort units with cooling capacity from 50 to 100 kW

This programme applies to factory-made units intended to produce cooled air for comfort air conditioning (AC1, AC2, AC3).

It also applies to units intended for both cooling and heating by reversing the cycle. AC1 programme units out of Regulation 206/2012 are excluded. AC2 and AC3 programme units out of Regulation 2016/2281 are excluded.

Participating Companies must certify all production models within the scope of the programme. For multi-split air conditioners, the number of indoor units is limited to 2, with same mounting type and capacity ratio  $1 \pm 0.05$ . However, AC2 & AC3 units with 3 or 4 indoor units can be declared as an option.

### CERTIFICATION REQUIREMENTS

For the admission & yearly surveillance procedures:

**AC1:** 8% of the units declared are selected and tested by an independent laboratory, and 30% of the selected units are tested at part load conditions.

**AC2 & AC3:** 10% of the units declared are selected and tested by an independent laboratory.

### CERTIFIED CHARACTERISTICS & ACCEPTANCE CRITERIA

- Capacity (cooling and heating) –5%
- Efficiency (EER and COP) at standard rating conditions and part loads: –8%
- AC1 Seasonal Efficiency (SEER and SCOP): –0% (automatically rerated when Part Load efficiency criteria fails)
- AC2 & AC3 Seasonal Efficiency (SEER/ $\eta_{sc}$  and SCOP/ $\eta_{sh}$ ): –0% (automatically rerated when Part Load efficiency criteria fails)
- A-weighted sound power level +0 dB (A)  
Auxiliary power +10%
- Minimum continuous operation Load Ratio:  
 $LR_{contmin}$  [%], COP/EER at  $LR_{contmin}$   
and Performance correction coefficient at  $LR_{contmin}$   
 $C_{pLR_{contmin}}$ .

### ECC REFERENCE DOCUMENTS

- Certification manual
- Technical Certification Rules ECP -01.

### TESTING STANDARDS

- EN 14511 • EN 14825 • EN 12102.

## CHILLED BEAMS

CERTIFY ALL



### SCOPE OF CERTIFICATION

This Certification Programme applies to all Active and Passive Chilled Beams. Chilled Beams are presented by ranges but all ranges must be certified. This applies to all product ranges which have either catalogue leaflets with product details including technical data or similar product information in electronic format.

### CERTIFICATION REQUIREMENTS

For the admission procedure: 3 units are selected from regular production and tested in the independent Laboratory selected by Eurovent Certita Certification.

For the surveillance procedures : the same as admission procedure, on a yearly basis, at fixed dates.

Obtained performances shall be compared with the values presented in the catalogues or electronic selection from manufacturer's website.

### CERTIFIED CHARACTERISTICS & ACCEPTANCE CRITERIA

Cooling capacity: 3 conditions are required.

- **Active:** 80 – 100 – 120% of the nominal air flow rate (for 8°C temperature difference)
- **Passive:** 6 – 8 – 10°C temperature difference.

Tolerance = -12% and +24% for the 3 single values;  
–6% for the average value.

Water pressure drop: tolerance = maximum (2 kPa; 10%)

### ECC REFERENCE DOCUMENTS

- Certification manual
- Operational Manual OM-12
- Rating Standard RS 2/C/001.

### TESTING STANDARDS

- **EN 14518:** "Testing and rating of Passive Chilled Beams"
- **EN 15116:** "Testing and rating of Active Chilled Beams".

## COMFORT & PROCESS CHILLERS\*

CERTIFY ALL

You will find the details of this programme in the refrigeration section.

## FAN COIL UNITS

CERTIFY ALL



### SCOPE OF CERTIFICATION

This Certification Programme applies to Fan Coil Units using hot or chilled water. It concerns both non ducted and ducted fan coils:

- Non-ducted units: Fan Coil Units with air flow less than 0.7 m<sup>3</sup>/s and a published external static duct pressure at 40 Pa maximum.
- Ducted units: Fan Coil Units up to 1 m<sup>3</sup>/s airflow and 300 Pa available pressure.
- District cooling units and 60 Hz units can be certified as an option.

Participating companies must certify all production models within the scope of the programme. Selection tools (software) are checked.

### CERTIFICATION REQUIREMENTS

Surveillance procedure: the number of units to be tested each year will be proportional to the number of his basic models listed in the Directory, in an amount equal to 17% for Fan Coil Units with a minimum of one test.

### CERTIFIED CHARACTERISTICS & ACCEPTANCE CRITERIA

- Sensible capacity\* \*\*: –8%
- Total cooling & heating capacity \* \*\*: –7%
- Water pressure drop\* \*\*: +20%
- Fan power input\*: +10%
- A-weighted sound power \*\*: +2 dB(A)
- Air flow rate: –10%
- Available static pressure 0 Pa for medium speed and –5 Pa for other speeds
- FCEER & FCCOP
- Eurovent energy efficiency class.

(\*) At standard and non-standard conditions

(\*\*) Acceptance criteria for capacities are increased by 2% for variable speed units.

### ECC REFERENCE DOCUMENTS

- Certification manual
- Technical Certification Rules ECP -FCU.

### TESTING STANDARDS

- EN 1397 "Hydronic room fan coil units – Test procedures for establishing the performance"
- EN 16583 "Hydronic room fan coil units – Determination of the sound power level".



INDOOR CLIMATE

## HEAT INTERFACE UNITS\*

CERTIFY ALL

### SCOPE OF CERTIFICATION

The present certification scheme covers Heat Interface Units, defined as a packaged unit including at least one Domestic Hot Water heat exchanger and control elements. The HIU may contain:

- An additional heat exchanger for heating
- Balancing elements
- 1 heating pump
- Metering possibilities

The HIU covered by the scheme are 3 pipes configurations. HIU with DHW capacity level above 70 kW are not covered by the certification scope. Only units for single family dwellings use are covered. The covered technologies are:

- Domestic Hot Water technology only: HIU/DHW
- DHW and direct heating technology: HIU/DHW/DH
- DHW and direct heating mixed technology: HIU/DHW/ DHM
- DHW and indirect heating application: HIU/DHW/IH.

### CERTIFICATION REQUIREMENTS

The Heat Interface Unit certification program includes:

- Annual random selection of units and tests in an independent and accredited laboratory.
- Annual production site audit
- Unit labelling
- Certify-all principle.

### CERTIFIED CHARACTERISTICS & TOLERANCE

- Maximal DHW capacity (kW)
- Return temperature during normal DHW tapping (°C)
- Minimal DHW flow rate (l/min)
- DHW reaction time (s)
- DHW Standby heat losses (kW)
- Capacity on temperature delta of 20 K (kW)
- Capacity on temperature delta of 10 K (kW)
- Difference between primary return temperature and secondary return temperature at 4kW (°C)
- Heat losses (kW).

### ECC REFERENCE DOCUMENTS

- Certification manual
- Technical Certification Rules ECP -27 rev. 1.

### TESTING STANDARDS

- Tests are conducted in accordance with the Test Regime Technical Specification, Rev-009 by BESA (Building Engineering Services Association), and in complement of testing specifications described in the Technical Certification Rules ECP -27 rev. 1.
- Units are both tested under High Temperature Conditions and Mid Temperature Conditions.



# EUROVENT HEAT PUMPS

Manufacturers certified for AC, VRF, RT & LCP-HP programmes can also apply for European Heat Pump certification

## SCOPE OF CERTIFICATION

- Electrically driven heat pumps for space heating (incl. cooling function)
- Electrically driven heat pumps used for heating swimming pool water (outdoors or inside)
- Dual-mode heat pumps, i.e. designed for space heating and domestic hot water production
- Gas absorption heat pumps (incl. cooling function)
- Engine-driven gas heat pumps (incl. cooling function)

Are excluded from the scope Cooling-only units, i.e. units declared only in cooling mode.

## CERTIFICATION REQUIREMENTS

Each range shall be certified according to one of the following related reference documents:

- **ECP-3 LCP-HP:**  
«Technical Certification Rules for the Liquid Chilling Packages & Hydronic Heat Pumps
- **ECP-1 AC:**  
"Technical Certification Rules for the certification of Air Conditioners"
- **ECP-15 VRF:**  
"Technical Certification Rules for the certification of Variable Refrigerant Flow systems"
- **ECP-13 RT:**  
"Technical Certification Rules for the certification of Rooftops"
- "Certification Reference for the Mark NF-414 for Heat Pumps".

## MAIN CERTIFIED CHARACTERISTICS & ACCEPTANCE CRITERIA

- Heating and/or Cooling capacities  $P_h$  and/or  $P_c$  [kW], Electrical Power inputs  $P_e$  [kW] and Coefficient of performance COP
- Design capacity  $P_{designh}$ , Seasonal Coefficients of Performance  $SCOP$ ,  $SCOP_{net}$  and Seasonal efficiency  $\eta_s$
- Minimum continuous operation Load Ratio  $LR_{contmin}$  [%], COP at  $LR_{contmin}$  and Performance correction coefficient at  $LR_{contmin}$   $C_{pl}LR_{contmin}$
- Temperature stabilisation time  $t_h$  [hh:mm], Spare capacity  $P_{es}$  [W], Energy efficiency for water heating [ $COP_{DHW}$  & WH] or Global performance coefficient for a given tapping cycle  $COP_{global}$ , Reference hot water temperature  $\theta_{WH}$  and Maximum effective hot water volume  $V_{MAX}$  [l]
- Daily consumption for the draw-off cycle in question (Qelec)
- Annual consumption (AEC)
- Sound power levels  $L_w$  [dB(A)].

## ECC REFERENCE DOCUMENTS

- Certification manual
- Operational manual OM-17
- Rating standard RS 9/C/010.

## TESTING STANDARDS

### Thermal performance:

- Heat pumps with electrically driven compressors
- Space heating & cooling: EN 14511-1 to 4;  
Seasonal performance: EN 14825
- Domestic hot water: EN 16147
- Direct exchange ground coupled heat pumps: EN 15879-1
- Gas-fired heat pump: EN 12309-1 to 5.

### Acoustics:

- Heat pumps and dehumidifiers with electrically driven compressors: EN 12102
- ISO 3741: Reverberant rooms or ISO 9614-1:  
Sound intensity, measurements by points.





# LIQUID-TO-LIQUID PLATE HEAT EXCHANGERS

## SCOPE OF CERTIFICATION

This certification programme applies to plate heat exchangers designed for liquid/liquid heat exchange (without phase change) applications in the Heating Ventilation and Air Conditioning (HVAC) field and operated with clean water or clean water mixtures (ethylene/propylene glycol but also ethanol aqueous solutions). The product categories covered are:

- Gasketed plate heat exchangers
- Brazed plate heat exchangers
- Fusion-bonded plate heat exchangers.

## CERTIFICATION REQUIREMENTS

The certification scheme is based on product performance testing by independent testing laboratories as well as manufacturing facility auditing and selection software checking.

For admission (entry year): 1/4 of the models (4 models minimum) selected for testing + 1 audit/factory.

For the surveillance procedure (annually): 1/10 of the models (2 models minimum) selected for testing + 1 audit/factory.

If more than 3 new models are introduced in the range during the declaration file annual update, then 1 extra test will be conducted.

The performances measured by the independent laboratory are compared to the selection software output data.

## CERTIFIED CHARACTERISTICS & ACCEPTANCE CRITERIA

- Capacity:  $-(3\%+\text{Mu})$
- Pressure drop on primary fluid circuit:  $+(10\%+\text{Mu})$ , minimum +2kPa
- Pressure drop on secondary fluid circuit:  $+(10\%+\text{Mu})$ , minimum +2kPa
- With Mu the expanded uncertainty calculated by the laboratory for the test in question (uncertainty analysis as per ECP-25-LPHE).

## ECC REFERENCE DOCUMENTS

- Certification manual
- Technical Certification Rules ECP -25.

## TESTING STANDARDS

Specific testing method in Technical Certification Rules ECP -25 notably based on, but amending, the following standards:

- EN 1148:1999+A1:2005
- EN 306:1997.

# ROOFTOP UNITS\*

CERTIFY ALL



The Eurovent rooftop certification (RT) program covers air-cooled packaged rooftop cooling only and reversible units below 100 kW (in cooling mode), with an option to certify air to air units from 100 kW to 200 kW and water-cooled packages rooftops.

The Rooftop program regroups 14 participants of which the five main European manufacturers.

**Mr. Denis Cathala**  
Programme Manager – Eurovent Certita Certification

## SCOPE OF CERTIFICATION

- This Certification Program applies to air-cooled packaged rooftop cooling only and reversible units below 100 kW (in cooling mode).
- Air to air units from 100 kW to 200 kW and watercooled packages rooftops can be certified as an option.

## CERTIFICATION REQUIREMENTS

- For the admission and surveillance procedures (yearly) between 1 & 3 units are selected and tested, depending on the number of products declared.

## CERTIFIED CHARACTERISTICS & ACCEPTANCE CRITERIA

- Capacity (Cooling or Heating):  $-5\%$
- EER or COP:  $-8\%$
- Seasonal Efficiency in cooling: SEER &  $\eta_{sc} -8\%$
- Seasonal Efficiency in heating: SCOP &  $\eta_{sh} -8\%$
- Condenser water pressure drop:  $+15\%$
- A-weighted Sound Power Level:  $+2$  dBA
- Eurovent Energy Seasonal Efficiency class.

## ECC REFERENCE DOCUMENTS

- Certification manual
- Technical Certification Rules ECP -13.

## TESTING STANDARDS

- EN 14511 for Performance Testing
- EN 14825 for Seasonal Efficiencies
- EN 12102 for Acoustical Testing.

## VARIABLE REFRIGERANT FLOW SYSTEMS\*



Launched in 2013, the VRF programme started with a restricted scope: outdoor units up to 50 kW, testable combinations up to limited number of indoor units (2 cassettes or 4 ducted units). But it was a first step to increase the integrity of the products performances on the market. From 2015, an annual factory audit has completed the requirements of the VRF programme.

Since 2018, an extended scope is proposed:

- Outdoor units up to 100 kW
- Combinations up to 8 indoor units (cassette or ducted) depending on the outdoor unit capacity
- Certified seasonal efficiencies (according to Ecodesign Regulation No 2016/2281 and No 206/2012 for VRF units below 12 kW)

Since 2019, the programme also covers high ambient VRF systems.

To date, the VRF programme gathers 30 participants some of which are leading manufacturers.

**Dr. Ali Alexandre Nour Eddine**  
Programme Manager – Eurovent Certita Certification



### SCOPE OF CERTIFICATION

The certification programme for Variable Refrigerant Flow (VRF) applies to:

- Outdoor units used in Variable Refrigerant Flow systems
- VRF units below 12 kW as combination of outdoor and indoor units with the following characteristics:
  - Air or water source, reversible, heating-only and cooling-only.
- VRF systems above 12 kW with data declared and published as combinations are excluded from the scope.
- Heat recovery units are included in the scope but the heat recovery function is not certified.
- High ambient systems are included in the scope but tested under specific conditions.

### CERTIFICATION REQUIREMENTS

- Admission: units selected by ECC shall be tested in an independent laboratory selected by ECC.
- Surveillance procedure: units selected from regular production shall be tested on a yearly basis.
- A factory visit is organized every year in order to check the production.

### MAIN CERTIFIED CHARACTERISTICS & ACCEPTANCE CRITERIA

- Outdoor Capacity (cooling and heating): -8%
- Outdoor Efficiency (EER, COP) at standard rating conditions and part loads: -10%
- Seasonal Efficiency (SEER/ $\eta_{sc}$  and SCOP/ $\eta_{sh}$ ): -0% (automatically rerated when Part Load efficiency criteria fails)
- A-weighted sound power level: 2 dB(A).

### ECC REFERENCE DOCUMENTS

- Certification manual
- Technical Certification Rules ECP -15.

### TESTING STANDARDS

- EN 14511
- EN 14825
- EN 12102
- ISO 15042:2017, SASO 2874:2016 and GSO 03 Draft for high ambient systems.

## CONDENSING UNITS

CERTIFY ALL



### SCOPE OF CERTIFICATION

The CDU programme covers air-cooled and water-cooled stationary condensing units designed for low (LT) and/or medium (MT) temperature applications in the field of commercial and industrial refrigeration and operated with the following refrigerants:

- R134a and list of alternatives (MT)
- R290 and list of alternatives (MT and LT)
- R448A and list of alternatives (MT and LT)
- R410A and list of alternatives (MT and LT)
- R744 (MT and LT).

The list of alternative fluids is defined in TCR ECP-27.

The scope is limited to the refrigerating capacities comprised between

- 0.1 and 20 kW included (LT)
- 0.2 and 50 kW included (MT).

### CERTIFICATION REQUIREMENTS

The certification programme is based on product performance testing by independent testing laboratory as well as production sites auditing.

### CERTIFIED CHARACTERISTICS & ACCEPTANCE CRITERIA

The product performance testing will enable the verification of the following ratings accuracy:

- Refrigerating capacity [W]: -10%
- Coefficient of Performance COP at full load: -10%
- Seasonal Energy Performance Ratio SEPR (EU 2015/1095) for Air Cooled CDU: -10%
- Sound power level [dB(A)]: +3 dB(A).

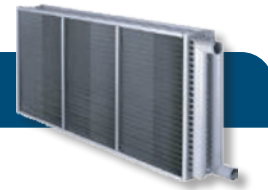
### ECC REFERENCE DOCUMENTS

- Certification manual
- Technical Certification Rules ECP -27.

### TESTING STANDARDS

- EN 13771-2:2017
- EN 13215:2016+A1:2020
- ISO 9614-2:1996.

## COOLING AND HEATING COILS



The Certification programme for the HCCs has increased integrity and accuracy of the industrial performance ratings which provides clear benefits for end users who can be confident that the product will operate in accordance with design specifications.

**Mr. Engin Söylemez**  
Test Engineer - Friterm A.Ş.

### CERTIFIED CHARACTERISTICS & ACCEPTANCE CRITERIA

- Capacity: 3%
- Air side pressure drop: +20%
- Liquid side pressure drop: +20%.

### ECC REFERENCE DOCUMENTS

- Technical Certification Rules ECP -09.

### TESTING STANDARDS

- EN 1216:1998+A1/2002

### SCOPE OF CERTIFICATION

The rating standard applies to coils operating:

- with water or with a 0-50% ethylene-glycol mixture, acting as cooling or heating fluid.
- and without fans.

### CERTIFICATION REQUIREMENTS

- Admission and surveillance procedures: units declared will be selected and tested by an independent laboratory.
- The number of units will depend on the variety of coil material configurations and their applications for the applied range.
- The selection software will be verified in comparison with the test results.
- On-site audits (checking of software).



## COOLING TOWERS



Reliable thermal performances are crucial to ensure the best efficiencies(...).

On a yearly basis, one random picked cooling tower of each Eurovent-CTI certified product line will be full scale thermal tested by applying the CTI standard 201.

**Mr. Rob Vandenoer**  
Product Manager, Quality Manager  
EVAPCO Europe BVBA

### The first ECC / CTI collaborative certification program for Cooling Towers

The Eurovent Certification Company (ECC, Brussels, Belgium) is pleased to announce the Certification programme for cooling tower thermal performance developed in cooperation with the Cooling Technology Institute Est.1950 (CTI, Houston, Texas, USA).

The scope of the program includes standardized model lines for open circuit cooling towers, typically factory assembled. Standardized model lines are composed of individual models that are required to have published thermal rating capacities at corresponding input fan power levels.

Thermal performance certification via this program offers a tower buyer assurance that the capacity published for the product has been confirmed by the initial and on-going performance testing per the requirements of the program using CTI STD-201. It also offers for regulators of energy consumption related to cooling towers, that the capacity of the towers has been validated. Minimum energy efficiency standards such as the Eurovent Industry Recommendation / Code of Good Practice Eurovent 9/12-2016 and ASHRAE 90.1, which requires cooling tower energy efficiency validation by the CTI certification process, are used by governments and by green building certification programs such as LEED™.



### SCOPE OF CERTIFICATION

This Certification Programme for Cooling Towers applies to product ranges (or product lines) of Open-Circuit series and Closed Circuit Cooling Towers that:

- Are manufactured by a company whose headquarter or main facility are located in Europe, Middle-East, Africa or India. After getting the Eurovent Certification, the CTI certificate could be requested.
- Have already achieved and hold current certification by the Cooling Technology Institute (CTI) according to CTI STD-201.

### CERTIFICATION REQUIREMENTS

For the admission & yearly surveillance procedures our internal auditor visits the production place and reviews the conformity of Data of Records. One unit per range is selected and tested by an independent test agency.

### CERTIFIED CHARACTERISTICS & ACCEPTANCE CRITERIA

- Certified characteristic shall be per CTI STD-201
- Entering wet bulb temperature: 10°C to 32.2°C (50°F to 90°F)
- Cooling range > 2.2°C (4°F)
- Cooling approach > 2.8°C (5°F)
- Process fluid temperature < 51.7°C (125°F)
- Barometric pressure: -91.4 to 105.0 kPa (27" to 31" Hg).

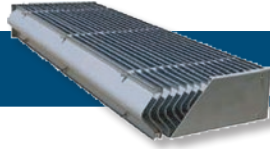
### ECC REFERENCE DOCUMENTS

- Certification manual
- Technical Certification Rules ECP -04.

### TESTING STANDARDS

- CTI STD-201 RS
- ECP-04-CT - Appendix A.





## DRIFT ELIMINATORS

### SCOPE OF CERTIFICATION

The Certification Programme for Drift Eliminators applies to Drift Eliminators used for evaporative water-cooling equipment.

### CERTIFIED CHARACTERISTICS & ACCEPTANCE CRITERIA

The following characteristics shall be certified by tests:

- For counter-flow and cross-flow film fill, the average drift losses of the two tests at 3.5 m/s are less than 0.007% of circulating water flow rate.
  - For cross-flow splash fill, the average drift losses of the two tests at 3 m/s are less than 0.007% of circulating water flow rate.
- No tolerance will be applied on the average drift losses.

### ECC REFERENCE DOCUMENTS

- Certification manual
- Technical Certification Rules ECP -14.

### TESTING STANDARDS

- CTI ATC-140.

## EVAPORATIVE COOLING

### SCOPE OF CERTIFICATION

The programme for Evaporative Cooling is divided in three sub-programmes, as it applies to Evaporative Cooling units in the following groups:

- Direct Evaporative Cooling (DEC)
  - Indirect Evaporative Cooling (IEC)
  - With primary outside air
  - With separation of external and room air
- Evaporative Cooling Equipment (ECE)
  - Water spray system
  - Wet media
  - Ultrasonic unit.

### CERTIFICATION REQUIREMENTS

All products of a declared range that fall into the relevant sub-programme scope and are promoted by the Applicant/ Participant shall be certified. This is a certification by range.

The certification programme is based on product performance testing by independent laboratories as well as manufacturing facility auditing. In the case of the IEC sub programme, the tests will be performed in the laboratory of the manufacturer supervised by an expert from an independent laboratory.

### CERTIFIED CHARACTERISTICS & ACCEPTANCE CRITERIA

- Cooling Capacity (all sub-programmes)
- Air flow (all sub-programmes)
- Efficiency (all sub-programmes)
- Water consumption (all sub-programme)
- Wet and dry pressure drop (ECE only).

### ECC REFERENCE DOCUMENTS

- Certification manual
- Technical Certification Rules ECP -24.

### TESTING STANDARDS

- For direct evaporating cooling AS 2913-2000 standard (ECP-24-EC)
- For indirect evaporating cooling ANSI/ASHRAE Standard 143-2015 (ECP-24-EC)
- For evaporating cooling equipment ASHRAE 133-2015 (ECP-24-EC).



# HEAT EXCHANGERS

CERTIFY ALL



The “Certify-All” principle ensures that, for heat exchangers, all models in the five product families are submitted for certification, not just some models chosen by the manufacturer.

**Mr. Stefano Filippini**  
Technical Director - LUVE



## CERTIFIED CHARACTERISTICS & ACCEPTANCE CRITERIA

- Standard capacity -8%
- Fan power input +10% with a minimum of 3 W
- Air volume flow  $\pm 10\%$
- Dimensions and number of fins: Finned length  $\pm 0,5\%$ , with a minimum of 5 mm
  - Height of the coil  $\pm 5$  mm
  - Depth (width) of the coil  $\pm 5$  mm
  - Total number of fins\*  $\pm 4\%$ , at least 2 fins
  - Diameter of (expanded) tube outside the coil\*  $\pm 1$  mm
- (\*) except for the micro-channels
- Energy ratio R
- Energy class

### For Dry Coolers:

- Liquid side pressure drop +20% with a minimum of 5 kPa

### For Air Cooled Condensers and Dry Coolers:

- A-weighted sound power level: +2 dB(A).

## ECC REFERENCE DOCUMENTS

- Certification manual
- Technical Certification Rules ECP -02.

## TESTING STANDARDS

- EN 328:2014
- EN 327:2014
- EN 1048:2014
- EN 13487:2019 and EN ISO 9614-1: 2009 Acoustics.

## SCOPE OF CERTIFICATION

The Eurovent Certification Programme for Heat Exchangers applies to products using axial flow fans.

The following products are excluded from the Eurovent Certification Programme for Heat Exchangers:

- Products units using centrifugal and radial type fans
- Units working at 60 Hz.

In particular, the following products are also excluded from the certification programme for Dx Air Coolers, CO<sub>2</sub> Dx unit coolers, Air Cooled Condenser and CO<sub>2</sub> gas cooler:

- Product ranges of Dx Air Coolers with maximum standard capacity SC2 below 1.5 kW
- Product ranges of Air Cooled Condensers with maximum standard capacity under TD1 15 K is below 2.0 kW
- Products ranges of CO<sub>2</sub> gas coolers with maximum standard capacity under SC20 below 2.0 kW
- Product ranges of CO<sub>2</sub> Dx unit Coolers with maximum standard capacity SC2 below 2.0 kW.

## CERTIFICATION REQUIREMENTS

- Admission: units selected by Eurovent Certita Certification shall be tested in an Independent Laboratory selected by ECC
- Surveillance procedure: units selected from regular production shall be tested on a yearly basis.



Air coolers for refrigeration (CO<sub>2</sub> & HFC)



Dry coolers



Air cooled condensers and CO<sub>2</sub> Gas coolers



# IT COOLING UNITS\*

CERTIFY ALL



## SCOPE OF CERTIFICATION

The present certification programme covers IT Cooling Units specifically designed and used to regulate air temperature and optionally air humidity of an enclosed space containing critical equipment such as IT equipment or telecommunication equipment.

The IT Cooling technologies considered in the scheme are Computer Room Air Conditioners Direct Expansion (CRAC) and Computer Room Air Conditioner Chilled Water (CRAH). HYBRID technologies pairing these technologies are also covered by the scope as an option.

The IT cooling units must be factory made units designed as a single packaged unit or a single split unit. Units must be 50 Hz frequency units, optionally 60 Hz units can be declared in addition to the 50 Hz. The units can be ducted or non-ducted units, as well on the air return or on the air supply. Floating floors air return or supply are considered as a duct.

## CERTIFICATION REQUIREMENTS

- Annual random selection of units and tests in an independent and accredited laboratory
- Annual production site audit
- Software certification extending the certification from standard functioning conditions to nonstandard conditions.

## CERTIFIED CHARACTERISTICS & ACCEPTANCE CRITERIA

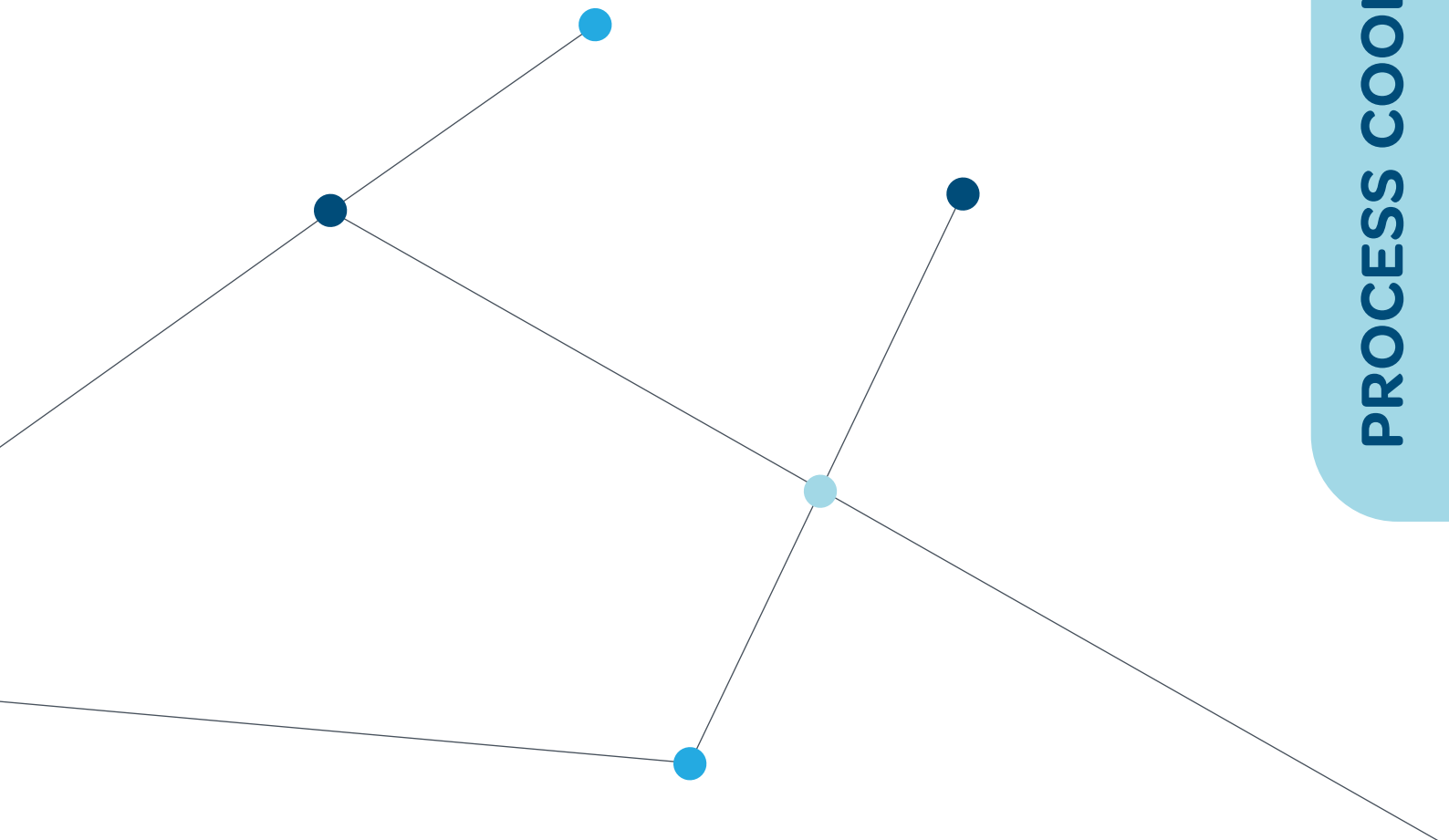
- Net Total Cooling Capacity (kW)
- Net Sensible Cooling Capacity (kW)
- Power input (kW)
- Net EER Energy Efficiency Ratio (%)
- Net SHR Sensible Heat Ratio (%)
- Water pressure drop (kPa)
- Supply Air Flow (m<sup>3</sup>/h)
- A-weighted sound power indoor side (dB(A))
- A-weighted sound power radiated by duct (dB(A))
- A-weighted sound power outdoor side (dB(A)).

## ECC REFERENCE DOCUMENTS

- Certification manual
- Technical Certification Rules ECP -23.

## TESTING STANDARDS

- EN 14511:2018
- EN 1397:2015
- ANSI/ASHRAE Standard 127-2012
- ASHRAE Standard 37
- EN12102-1 :2017
- EN 16583:2015
- SASO 2874:2016.





# COMFORT & PROCESS CHILLERS\*

CERTIFY ALL

According to the last Ecodesign Regulations (No 811/2013 - No 813/2013 – No 2016/2281) the programme proposes the certification of Seasonal efficiency for heating ( $\eta_s$  & SCOP) or Chillers & Heat pumps with a design capacity below 70kW, Seasonal efficiency for cooling ( $\eta_{sc}$  & SEER) for all comfort chillers and the seasonal energy performance ratio (SEPR) for process chillers.

The programme proposes also:  
 – From 2019, high ambient conditions for specific markets  
 – From 2020, the certification of the Selection software covering nonstandard conditions and units with options.

## SCOPE OF CERTIFICATION

- This programme applies to standard chillers and hydronic heat pumps used for heating, air conditioning and refrigeration.
- They may operate with any type of compressor (hermetic, semi-hermetic and open) but only electrically driven chillers are included.
- Only the refrigerants authorised in the EU, including the toxic and flammable ones, are considered.  
Chillers may be air cooled, liquid cooled.

Can be certified as an option:

- Heating-only hydronic heat pumps, 60 Hz units, 4-pipe units (multipurpose), Air-cooled units above 600 kW. Water-cooled units above 1500 kW.
- High ambient conditions for Middle East & India
- Medium and Low Temperature Process Chillers.

## CERTIFICATION REQUIREMENTS

Admission and surveillance: a certain number of units will be selected by Eurovent Certita Certification and tested every year, based on the number of ranges and products declared. The selection software will be verified in comparison with the test results.

## CERTIFIED CHARACTERISTICS & ACCEPTANCE CRITERIA



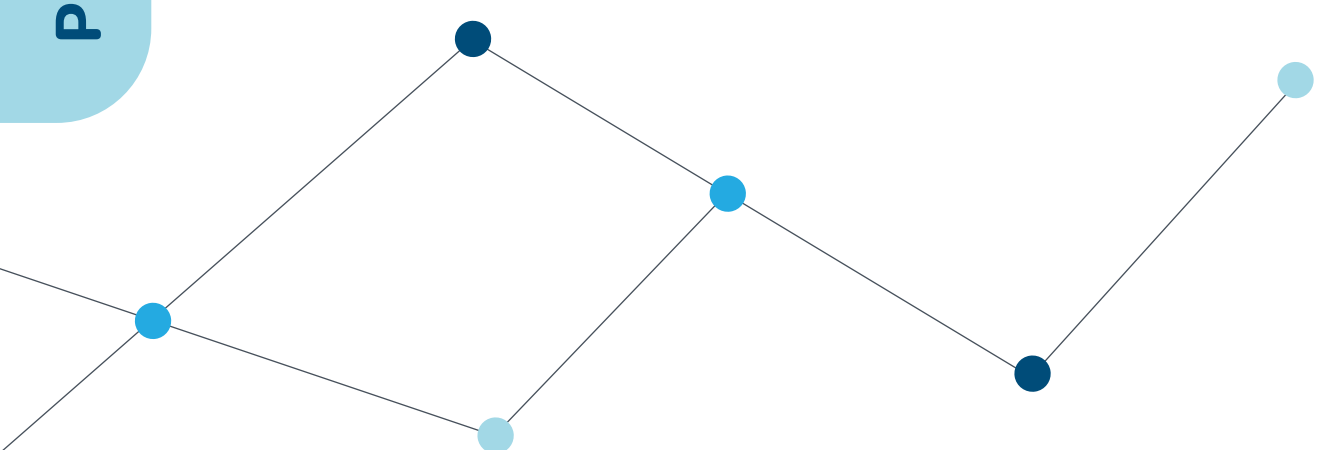
- Cooling & heating capacity, EER & COP at standard rating conditions, TE: < -5%, ISEER & Pdesign
- Seasonal efficiencies SCOP &  $\eta_s$ : automatically rerated when Part Load efficiency criteria fails
- Seasonal efficiencies SEER &  $\eta_{sc}$ : automatically rerated when Part Load efficiency criteria fails
- Seasonal efficiency SEPR: automatically rerated when Part Load efficiency criteria fails
- A-weighted sound power level: > +3 dB(A) (> +2 dB(A) for units with Pdesignh below 70 kW)
- Water pressure drop: +15%
- TER (Total Efficiency Ratio) for 4-pipe units.

## ECC REFERENCE DOCUMENTS

- Certification manual
- Technical Certification Rules ECP -03.

## TESTING STANDARDS

- Performance testing: EN 14511, SASO 2874
- Seasonal Performance testing: EN 14825, IS 16590
- Sound testing: EN 12102.



# REFRIGERATED DISPLAY CABINETS

CERTIFY ALL



What would you trust more: a self-declaration by the Manufacturer or what an independent, globally recognized and forerunner certification program is able to assure? Which one is better?

**Mr. Maurizio Dell'Eva**  
Project manager - EPTA S.P.A.



## CERTIFIED CHARACTERISTICS & ACCEPTANCE CRITERIA

- Warmest product temperature (laboratory conditions): +0.5 °C
- Coldest (chilled) product temperature (laboratory conditions): -0.5 °C
- Heat extraction (laboratory conditions) [kWh/24h] (RRDC): +10 % (RRDC)
- Evaporating temperature (laboratory conditions) (RRDC): -1 °C (RRDC)
- DEC [kWh/24h]: +5 % (RRDC), +10 % (IRDC)
- REC [kWh/24h]: +10 % (RRDC)
- TEC [kWh/24h]: +10 %
- TDA [m<sup>2</sup>]: -3 %
- Energy Efficiency Index EEI (laboratory condition): Failed if TEC is failed
- Specific daily Electrical Energy Consumption: Failed if TEC is failed (IRDC)
- The measured M-package temperature class shall equal to or inside the claimed class, with an acceptance criterion of : +/-0.5 °C.

## ECC REFERENCE DOCUMENTS

- Certification manual
- Technical Certification Rules ECP -07.

## TESTING STANDARDS

- EN ISO 29953 and amendments.

## SCOPE OF CERTIFICATION

- 100 basic model groups divided in 5 categories of remote units: semi-verticals and verticals (with doors); multi-deckers; islands; service counters; combi freezers.
- **2 sub programmes :**
  - Remote Refrigerated Display Cabinets (RRDC) using R744 (CO<sub>2</sub>).
  - Integral Refrigerated Display Cabinets (IRDC) equipped with air-cooled condensing unit using natural refrigerants or blends with GWP lower or equal to 150.
- At least two references per basic model group representing 80% of sales shall be declared.

## CERTIFICATION REQUIREMENTS

- Admission: sampling and test of one unit & audit of one factory.
- Surveillance: sampling and test of two units and audit of two factories maximum each year.

# TWIN COILS HEAT EXCHANGERS

## SCOPE OF CERTIFICATION

This certification programme covers the heat recovery exchangers with intermediate heat transfer medium corresponding to the category IIa ("without phase change") of the EN 308:1997 standard, that is Run Around Coils systems.

## CERTIFICATION REQUIREMENTS

### Admission procedure:

- Product performance testing:
  - 1 coil per BMG to be selected
  - Selected coils paired into systems (1 "exhaust" coil + 1 "supply" coil)
- Operating software checking
- Audit of the manufacturing facilities

### Surveillance procedure:

- Product performance testing: 1 system to be selected (1 "exhaust" coil + 1 "supply" coil)
- Operating software checking
- Audit of the manufacturing facilities.

## CERTIFIED CHARACTERISTICS & ACCEPTANCE CRITERIA

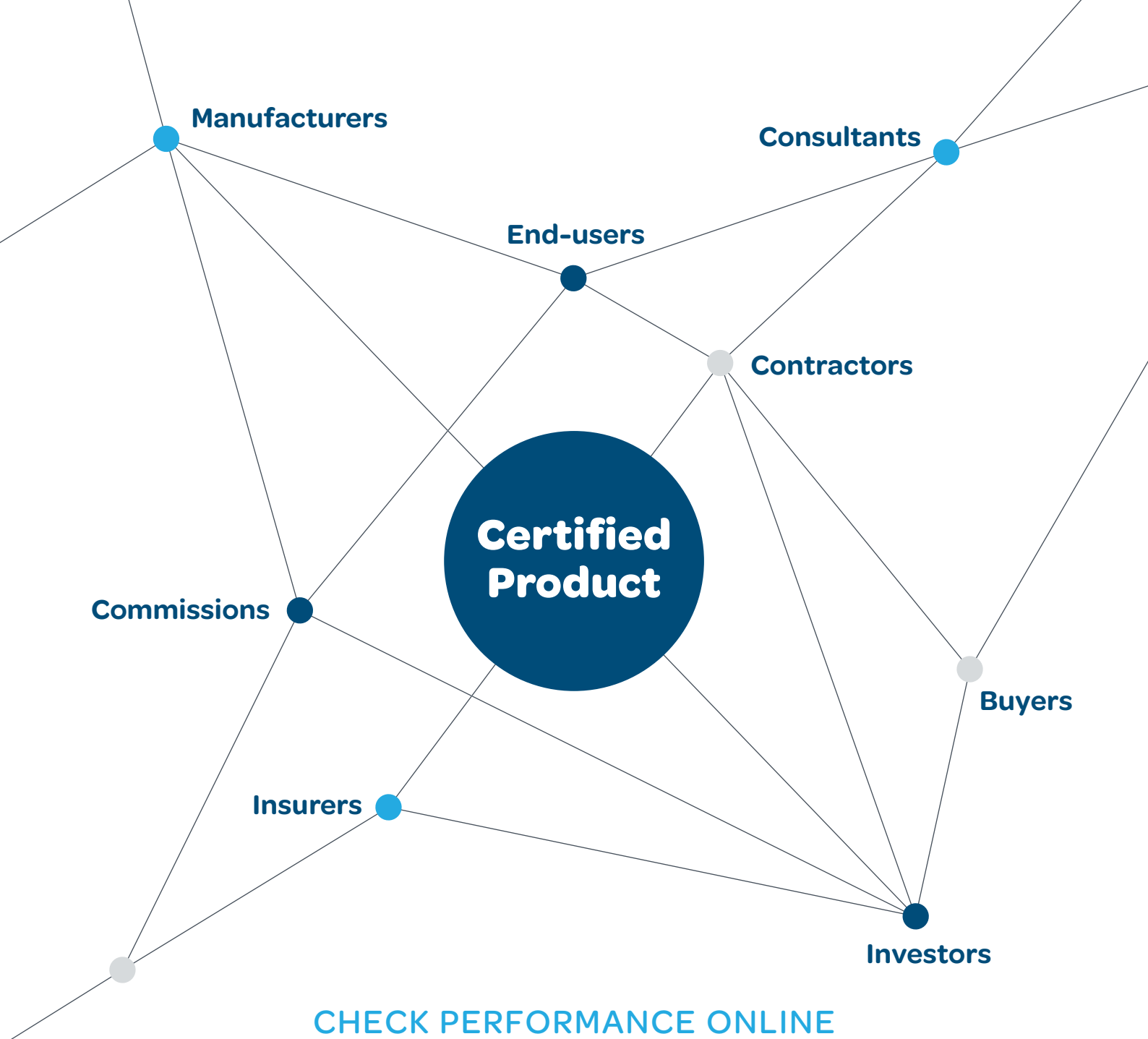
- Dry heat recovery efficiency [%]
- Air side pressure drop at standard conditions for each coil [Pa]
- Fluid side pressure drop for each coil [kPa] When tested in the laboratory the obtained performance data shall not differ from the recalculated values ("test-check") by more than the following tolerance values:
  - Dry heat recovery efficiency: -3 percentage points (abs. deviation)
  - Air side pressure drop: Maximum [+10%; +15 Pa]
  - Fluid side pressure drop: Maximum [+10%; +2 kPa].

## ECC REFERENCE DOCUMENTS

- Certification manual
- Technical Certification Rules ECP -18.

## TESTING STANDARDS

- EN 308:1997.



**Certified Product**

**CHECK PERFORMANCE ONLINE**  
**[www.eurovent-certification.com](http://www.eurovent-certification.com)**



**Eurovent Certita Certification**  
48-50 Rue de la Victoire, 75009 Paris, FRANCE  
+33 (0)1 7544 7171  
[apply@eurovent-certification.com](mailto:apply@eurovent-certification.com)



# Why embrace the EU framework for sustainable buildings (and where to start)?



**JOSEFINA LINDBLOM**  
Policy Officer, DG ENV, European Commission

Anyone who follows developments at EU level will know that building sector policies and legislation, including those affecting the HVAC market, are being updated to help improve sustainability performance throughout the building life cycle – from design to end-of-life. This reorientation to a more circular built environment will be essential in delivering on commitments under the European Green Deal to reduce net greenhouse gas emissions to zero by 2050 and to decouple economic growth from resource use.

That is why, whenever my colleagues and I speak at industry events, buildings professionals, product manufacturers, business leaders and policymakers at national, regional and local level always seem to want to know one thing: how to stay ahead of the legislation and be ready to embrace changes in their working environments. Our answer is ‘Level(s)’, the EU common language framework guiding the sustainability performance assessment of buildings.

## So, what is Level(s)?

Level(s) is a sustainability performance assessment solution. It has six objectives, addressing the main sustainability considerations throughout the building life cycle, from planning and design through to deconstruction and demolition. It can be used by all kinds of buildings professionals, including planners, procurers, product manufacturers, architects, heating and ventilation experts, waste management professionals and many others.

The sustainability indicators within each Level(s) objective describe how a building’s performance can be aligned with EU policy in areas such as indoor air quality, energy, material use, water, waste, and resilience to climate change.

While Level(s) has been freely available since October 2020, you will be pleased to learn that the European Commission recently published a new eLearning programme to make Level(s) easily accessible to professionals across the sector. So, if you are someone who is interested in Level(s) but unsure where to begin, the eLearning programme is your new starting point.

## Why start using Level(s) now?

By starting to use Level(s) now, you will stay ahead of (and be compliant with) revisions to legislation. For example, the European Commission has



proposed a revision to the Energy Performance of Buildings Directive. It calls for buildings professionals to calculate the life cycle Global Warming Potential (GWP) for most new builds from 2030, using the Level(s) methodology. For large buildings (with a useful floor area of more than 2 000 square meters) the obligation to calculate GWP would apply sooner, as of 2027. Level(s) also informed the recent Commission Proposal for the Construction Product Regulation, which sets harmonised rules for CE marking construction products in the EU. The proposal covers the macro-objectives of Level(s) in the ‘basic requirements for construction works’ in Annex I of the Regulation. According to the plans, characteristics addressed in Level(s) will be part of the declaration of performance for CE marked products. Level(s) is referenced in the proposed revision of the Energy Efficiency Directive (EED) too, adopted by the Commission in July 2021. For the first time, the EED encourages Member States to include the life cycle perspective when procuring public buildings. Furthermore, Level(s) will be the basis for the revision of the Green Public Procurement Criteria for office buildings. These criteria will be expanded to cover schools and social housing, and will pay particular attention to renovation. We want to make them even more firmly based on circularity and life cycle principles. We can do so thanks to the Level(s) indicators. In short, Level(s) is guiding changes to several pieces of legislation, creating a strong incentive for the building sector to adopt the framework. That is where the new eLearning programme comes in!

## How do you navigate the eLearning programme?

The eLearning programme is divided into seven self-guided eLearning modules.

We advise all users to take the opening Introduction module (Module 0), which will help you to get familiar with the purpose and metrics of the macro-objectives and indicators behind the Level(s) framework. It will also help you understand how to define the appropriate assessment level at each project stage and to apply the indicators in your context.

After completing the introduction, you can choose from a further six modules (Modules 1-6) covering each of the Level(s) macro-objectives and their corresponding performance indicators. Each module takes you step by step through the indicators you are interested in. You will cover the aim of each indicator, what you need for assessing performance, what to measure, and how to assign roles and responsibilities.

What many people reading this will appreciate is that the eLearning programme is fully customisable. With such a wide variety of buildings professionals interested in using Level(s), we have designed a programme that is adaptable to different needs and interests. This means you can pick and choose the modules most relevant to you or complete the programme from start to finish. Alternatively, you can select from a number of guided learning journeys, covering occupant welfare, global warming, circularity, future-proofing, and sustainable finance.

## A case study approach

Throughout the eLearning programme you will explore a detailed case study showing how experts working on an office building project in Madrid applied each Level(s) indicator in their working environment. For example, Module 3 covers the Level(s) macro-objective on the efficient use of water resources. After completing the module and reinforcing your knowledge with a quiz, the case study will show you how the team used Level(s) to assess and monitor sustainability performance on water consumption at Level 1 (during the conceptual design assessment), Level 2 (during the detailed design and construction stages) and at Level 3 (when the building was in use, following handover to the client). You’ll read about all the factors they took into consideration and see their data and calculations, giving you deeper insight into how to put Level(s) into practice on your project.

## Is the Level(s) eLearning programme for you?

The programme is for professionals involved in each or all the different stages of the building lifecycle - whether you're new to Level(s) or more experienced. The course materials also highlight the roles and responsibilities for each type of building professional when using Level(s). This means the eLearning programme is suitable for use by experts throughout the built environment. And of course, the programme covers the Level(s) sustainability performance assessment indicators likely to be of concern to REHVA members, such as those associated with indoor air quality, lighting, heating, ventilation and air conditioning, for example.

## What else is new from Level(s)?

The Commission has released a new Calculation and Assessment Tool (CAT) to make it easier to measure sustainability performance, the Level(s) way. CAT is there to support you to complete life cycle assessments using Level(s) during the different life cycle stages. It is a user-friendly solution for completing Level(s) assessments on your building projects and provides a simpler way to calculate and compare results between different projects. Its interface is designed with SMEs and micro-enterprises in mind and there are no fees or charges for using CAT.

## Need more information?

In case you missed it, you now can watch the video recording of the Commission's recent webinar (recorded on 3 June this year), introducing the eLearning programme and CAT to buildings professionals. The two-hour session gives a detailed overview of all the resources, as well as examples of different applications. The question-and-answer sessions during the event will anticipate many of the queries you may have, so be sure not to miss it.

## Take your first steps into Level(s)!

Watch the webinar, recorded on 3 June 2022, introducing the new tools and addressing questions from buildings professionals like you. Visit <https://www.youtube.com/watch?v=-ms2XF9iSW4>.

You can find out more about Level(s) and access the eLearning programme and CAT tool on the Level(s) website. There, you will also find a short animation and set of factsheets introducing the new tools. Visit [ec.europa.eu/environment/levels](https://ec.europa.eu/environment/levels).

Finally, to keep updated with all the latest Level(s) developments, including updates to the eLearning programme and CAT, be sure to subscribe to the Level(s) LinkedIn Group. Visit <https://www.linkedin.com/groups/12501037/>. ■

## What can I do with CAT?

Buildings professionals can work with CAT in many ways, but some of the most common use cases include:

- Testing different approaches to the design, construction, de-construction and maintenance of a building.
- Evaluating the relative advantages and disadvantages of, for example, different materials, and design options when exploring the most effective solutions for your project, taking into account sustainability considerations and life cycle costs.
- Compiling a choice of sustainability performance options in a clear and transparent way for your customers.

# Indoor air quality – why it is important and what it hinges upon.



Each day is made up of 24 hours – of these 24 hours, we spend an average of 21.6 hours, i.e. 90%, inside buildings. During that period, we also breathe in around 12,000 litres of air.

We do this in the belief that the indoor air is “clean” and not harmful to us. This makes it even more astonishing that the occupants and operators of buildings have little knowledge of the actual air quality in the rooms being used: Significant indicators such as air humidity, CO<sub>2</sub> content or the concentration of VOC (volatile organic compounds) are only rarely measured and also practically never visualised.

## Statutory requirements regarding indoor air quality

Germany has for example the standards DIN EN 16798 and VDI 6022, among others, which contain detailed requirements with respect to indoor air quality. These are used to determine how much outdoor air is required for which occupancy in a room in order for the CO<sub>2</sub> content to remain below the threshold of 1,000 ppm. Interestingly enough, considerably more precise measured values and regulations exist for outdoor air than are available for indoor air. And there is a good reason behind this –The WHO and Swiss Lung Association now believe that chronic obstructive pulmonary disease (COPD) is one of the most common causes of death worldwide. Indoor air therefore needs to provide quality comfort,

## Editorial

Do we care about the quality of the water that we drink? But of course! And what about the quality of the air that we breathe in at home and in the office? Let’s be honest: Do we even know anything about this? It never fails to astonish me how little importance we attach to our indoor air, even though it is actually a “staple food” for us. Numerous studies have shown the direct connection between health, well-being and air quality. Temperature and CO<sub>2</sub> content have a direct influence on the concentration and productivity of people in buildings. The issue of air quality found unexpected popularity as a result of the Covid pandemic. In just a short time, a broader awareness emerged regarding indoor airflows, the concentration and spread of viruses, and the role of air humidity. It is now known that the concentration of aerosols and the duration of stay in a room are decisive factors for the risk of viral infection, and that CO<sub>2</sub> concentration is a good indicator of the degree of “biocontamination” in the room. Fortunately, interest in air quality sensors has increased, and “red traffic lights” in offices have increased pressure on building operators. Far less well known is the equally important issue of mechanical removal of contaminated air and the controlled introduction of fresh air. A great deal of educational outreach is still required here. Many solutions would be available for this problem. But what really matters when it comes to renovating ventilation technology in buildings? Belimo conducted a global survey among planning engineers and experts in the ventilation industry to identify the most important factors for healthy indoor air. You will find the overview of our findings under the title “The 7 Essentials of Healthy Indoor Air” on the next pages. The good news: The technology and products for better indoor air are available. Even with relatively small investments, an existing ventilation system can be upgraded and significantly optimized; not only for improved comfort, but also at the same time for higher energy efficiency. I am convinced that in coming years we will be seeing a massive forward movement in the area of “healthy indoor air”. And now I hope you enjoy reading about the current situation!



**Dr. Adrian Stauffer**  
Head of Group Division  
EMEA at Belimo



be hygienically clean and should jeopardise neither our health nor our well-being. This can be achieved with a good ventilation system. Belimo is making a vital contribution to meeting this challenge by providing field devices for the heating, ventilation and air-conditioning industry. An entire product range of sensors for measuring the most important factors affecting room climates, such as air quality, temperature, air humidity and flow are the bases for ensuring good indoor air quality. VAV technology perfectly balances airflows at all times, and pressure-independent valves control water flows for consistent thermal comfort.

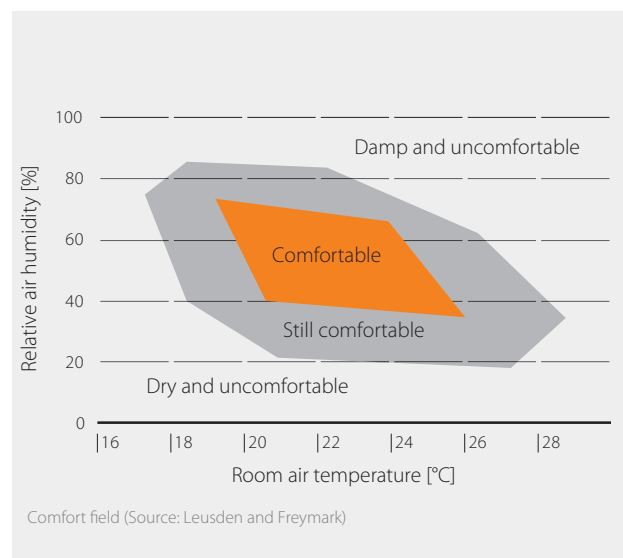
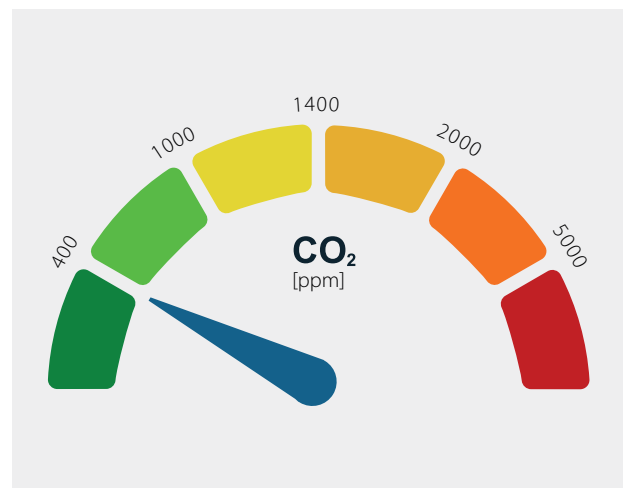
### Better air quality leads to higher performance ability

The air around us is comprised of 21% oxygen, 78% nitrogen, 0.04% carbon dioxide (CO<sub>2</sub>) as well as traces of noble gases, water vapour and pollutants. Today, one of the most important indicators of air quality in closed rooms is the CO<sub>2</sub> value. Because humans also produce CO<sub>2</sub> by breathing and adding this to the air, the concentration of CO<sub>2</sub> continually increases in closed rooms where people are present. An air tight building shell reduces the air exchange rate, resulting in an increased concentration of harmful substances in the indoor air. This can be counteracted by regularly venting rooms or, if this isn't possible, by fitting a ventilation system to take on this task. Because a ventilation system also reliably removes air pollutants, it sustainably improves the air quality in occupied rooms. If such rooms are equipped with sensors, which permanently provide data to the ventilation plant room, the system becomes reliable and energy-efficient.

### Measurement results in schools and educational establishments

Currently, more than 30% of children in Europe suffer from allergy-related illnesses, such as asthma, hay fever or neurodermitis. A connection with the omnipresent pollution of the environment and thus of the air cannot be ruled out. After all, large quantities of pollutants can accumulate, particularly in closed rooms, where they can then also enter the bloodstream when the air there is breathed, as measurements in educational institutions have determined. In addition to chronic illnesses, contaminated indoor air also has other effects on well-being: In order to discover the concrete effects

of air quality on pupils and teachers, the MeineRaumluft.ch platform joined forces with the Zurich Teachers' Association (Zürcher Lehrerinnen- und Lehrerverband) and the Zurich Lung Organisation ("Lunge Zürich") to install measuring devices in over 250 classrooms, which have now been in place since November 2016. The installation of the measuring device alone effects a positive change on the ventilation behaviour of both teachers and students, in that they opened the windows for ventilation as soon as the CO<sub>2</sub> concentration became too high. Measurements by the University of Stuttgart showed that the better solution in the long term is the installation of permanently installed ventilation units with outdoor air exhaust-air operation and heat recovery. Seven essential factors for healthy indoor air in non-residential buildings have emerged in the effort to create a healthy indoor air climate. Belimo has identified these in a worldwide survey of planners and experts from the ventilation industry.





# The 7 Essentials of Healthy Indoor Air

**What is important in building, renovating or operating an HVAC system to ensure healthy indoor air? Belimo identified seven essential factors for ensuring healthy indoor air in buildings.**

## 1. Continuous and Reliable Measurement, Display and Monitoring of Indoor Air Quality

Ideally, relative humidity, temperature, CO<sub>2</sub> content and VOC concentration are measured for the monitoring of air quality. A value cannot be improved unless it is measured. Reliable sensors are needed to ensure exact measurements, the results of which will then in turn trigger such measures such as ventilation, air exchange or humidification.

## 2. Precise amount of supplied air and controlled removal of contaminated air

Of central importance for good indoor air quality is the supply of a certain amount of outdoor air and the controlled removal of contaminated air from the room. Rooms must therefore be supplied with a variable air volume (VAV) that is dependent on accommodation and occupancy. In the case of central ventilation systems that supply multiple rooms, it must be possible to control the supply and exhaust air flows individually.

## 3. Well-designed air dilution and airflow pattern

The important thing is how the outdoor air flows through the room, in addition to how the extract air exits that same room. Ideally, outdoor air flows undiluted past a person from below to above and is then extracted directly from the room. It must be ensured that indoor air does not swirl around multiple times or collect in certain zones of the room.

## 4. Active pressurisation of building envelope and spaces

Unwanted inflows of polluted air from outdoors or from other rooms such as a cafeteria can be prevented by correctly balanced air-pressure conditions. This is ensured by using VAV controllers in the supply and extract air as well as differential pressure sensors and controllers.

## 5. Correct temperature and humidity control

In central ventilation systems, the supply air can be conditioned to the exact desired temperature using heating and cooling coils. High-quality control components such as the Belimo Energy Valve™ ensure that this is done not only with maximum precision, but also with energy efficiency. In addition to temperature, a humidity level of 40-60% relative humidity is also an essential factor for healthy indoor air.

## 6. Effective filtration

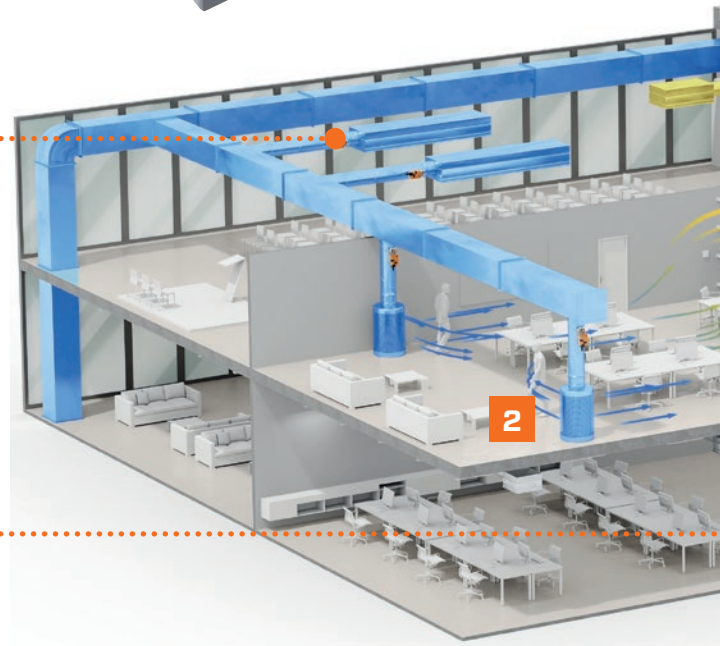
A ventilation system contains filters in order to avoid contaminations being added to the air. In systems where part of the extract air is mixed back into the supply air, suitable filters are used to prevent contamination from infectious microbes (for example, HEPA filter H13 pursuant to EN1822.2009). Here, too, pressure sensors are used for monitoring the filter output and for airflow measurement.

## 7. Proper Amount of Outdoor Air

Many countries have, in the meantime, issued, recommended or even mandated standards for mechanical ventilation in commercial buildings and required minimum air-change rates, depending on the type of building and the number of occupants (for example ASHRAE 62.1). An automated and sensor-regulated system can supply more outdoor air when the outdoor air quality is high, and then return to the minimum required ventilation rates when outdoor air pollution levels are on the rise

## VAV SOLUTIONS FOR DEMAND-CONTROLLED VENTILATION

The air we breathe impacts our health and productivity; the precise control of airflow is therefore of crucial importance in every operating range. Well-designed variable air volume (VAV) systems ensure the proper amount of outdoor air is supplied and polluted air is removed in a controlled manner from the room. Belimo offers VAV controllers and actuators that can be tailored to specific requirements: The VAV-Compact is suitable for more complex applications. This combines an actuator, a controller and a sensor in a single device and is ideally suited for systems with variable and constant airflow rates. The modular structure of the VAV-Universal consists of a VRU controller with an integrated differential pressure sensor that controls the volumetric flow specified by the room automation system, e.g., room temperature or air quality controller.



## SENSORS FOR MEASUREMENT OF INDOOR AIR QUALITY

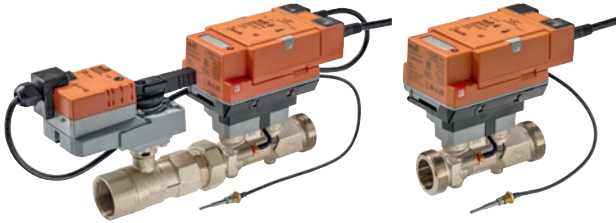
What cannot be measured cannot be controlled. Belimo offers a wide range of room and duct sensors to accurately measure temperature, relative and absolute humidity, enthalpy, dew point, CO<sub>2</sub> and VOC. The range includes active and passive sensors. The duct sensors have a robust design that meets IP65 / NEMA 4X requirements. Active room sensors can be put into operation and checked for errors using the Belimo Assistant App on a smartphone. In addition to their precision, Belimo sensors are characterised by short response times and low drift rates. This ensures long-term stability.



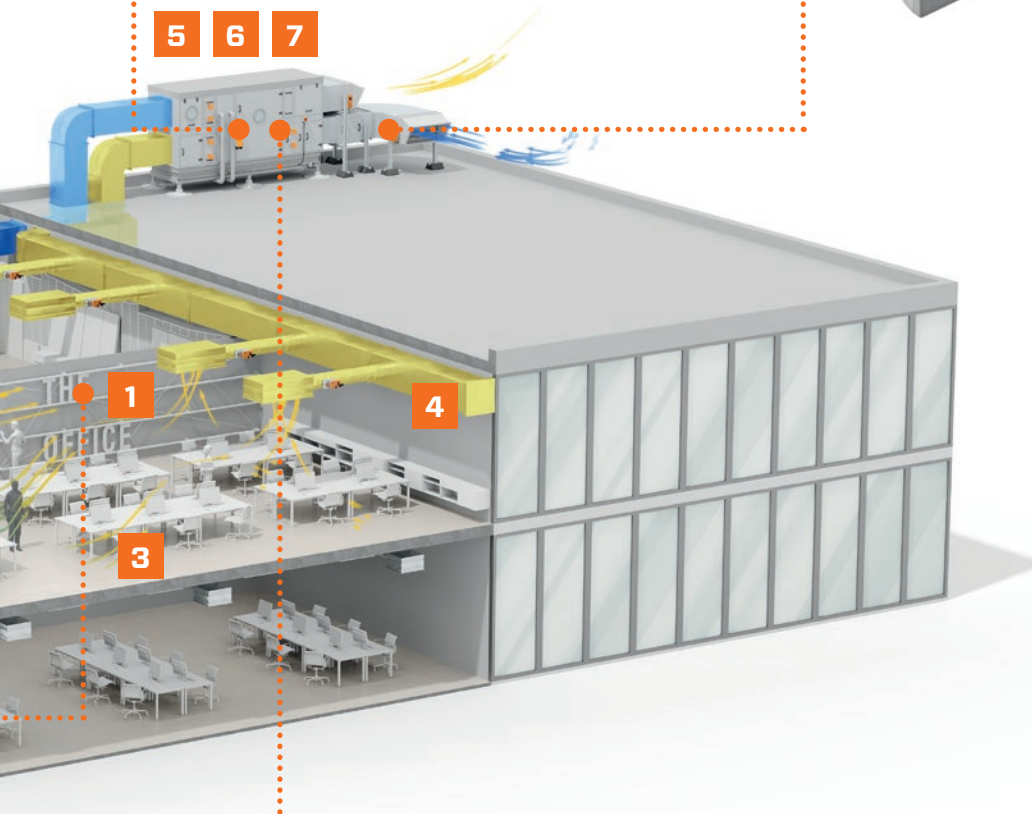


**PRESSURE-DEPENDENT, TRANSPARENT THERMAL ENERGY SUPPLY**

The correct conditioning of the supplied air is essential for healthy indoor air. Also, to be achieved at the same time is a high energy efficiency with respect to the exchange of heat from water to air. In addition to the thermal energy meter, the Belimo Energy Valve™ consists of a 2-way or 3-way characterised control valve and an actuator with integrated logic, while at the same time providing additional measurement, regulation and control functions.



5 6 7



**DAMPER ACTUATORS FOR A WIDE VARIETY OF APPLICATIONS**

Damper actuators are indispensable for healthy indoor air and for ensuring the reliable functioning of HVAC systems. They ensure the proper amount of outdoor air at the air intake and they control supply, return and recirculated air inside the air handling unit. Furthermore, our actuators operate the outdoor air dampers to reliably seal off the inflow of air in the event of a power failure, so that no ice formation occurs. Other damper actuators are usually located close to the zone, and provide the right amount of fresh air and the desired airflow pattern via the air inlets according to demand. Belimo damper actuators offer low power consumption and a wide torque range with direct-coupled, rotary, or linear travel, along with fast running models for simple to exceptionally complex HVAC applications.

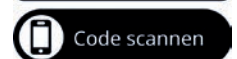


**SEAMLESS INTEGRATION IN BUILDING MANAGEMENT SYSTEMS AND IOT PLATFORMS**

The digital integration of field devices ensures flexibility in HVAC solutions which can be controlled, monitored and serviced from anywhere. Belimo products support the open communication protocols Modbus and BACnet via serial and IP-Bus systems. In addition to the possibility of linking them directly to the building management system, Belimo's IoT-ready products can also be used with modern IoT platforms for buildings, thus offering inputs to transfer sensor measurement values to the digital ecosystem and dispensing with the need for additional controller inputs.

**PRESSURE SENSORS AND SWITCHES FOR FILTER MONITORING**

Air filters help ensure that air supplied to the zones is not contaminated by pollutants, such as fine dust and pathogens, from the outdoor or recirculated air. In order to ensure healthy indoor air and save energy, the filter should be replaced on the basis of its degree of contamination and not on the basis of particular time intervals. Belimo's air pressure switches are a cost-efficient and reliable way to monitor filters in systems with constant air volume flow. And in systems with variable air volumes for demand-controlled ventilation, a differential pressure sensor is the ideal solution.



## Room units from Belimo



The new room units (room sensors and room operating units) are the perfect addition to the existing product range. With the expansion of the product range for visible areas of the room, Belimo offers architects an aesthetic and timeless design, installers a quick installation, system integrators easy commissioning via smartphone and end users a comfortable and healthy room climate.

- Aesthetic, timeless design
- Room operating units **with ePaper touch display**
- Fast installation thanks to spring-loaded terminal blocks and snap-on cover
- Configuration, setpoint adjustment and diagnosis of active devices via app



## Belimo Display App



The Belimo Display App is the most innovative way to access Belimo sensors. With the intuitive end user app, the current room values can be displayed and setpoints can be adjusted. Access protection prevents changes by unauthorised persons. This means that any unintentional adjustment of the setpoints is blocked in publicly accessible rooms (e.g. schools).

- Innovative setpoint adjustment with the intuitive app, without the need for a display on the room unit
- Compatible with the latest generation of active Belimo room sensors and operating devices
- Optional access protection with a four-digit code
- Display of the CO<sub>2</sub> concentration with a customisable traffic-light function



**For Germany:**  
 Bernd Wittenberg  
 Sales Manager North  
 Tel.: +49 711 16783-59  
 Mobile: +49 172 7167833  
 bernd.wittenberg@belimo.de



**For Germany:**  
 Bruno Massagué  
 Sales Manager South  
 Tel.: +49 711 16783-56  
 Mobile: +49 172 1678310  
 bruno.massagué@belimo.de



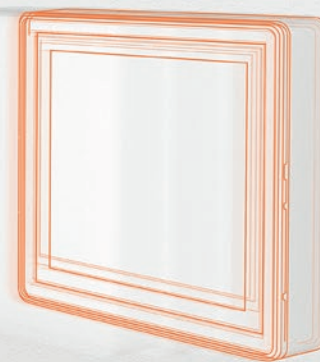
**For Switzerland:**  
 Rony Riedo, Head of Department  
 Sales Switzerland  
 Tel.: +41 43 843 62 78  
 Mobile: +41 79 226 46 46  
 rony.riedo@belimo.ch



**For Austria:**  
 Jürgen Obmayer  
 Head Field Sales  
 Tel.: +43 1 7490361 0  
 Mobile: +43 664 88296605  
 juergen.obmayer@belimo.at



## New room operating units and display app.



### Launch event: 30 August 2022

Learn from our specialists and customers at our online event as they share the innovative features of our new room operating units with display or with display app.

Our experts use practical examples to show how to use our newest devices and as a result not only increase energy efficiency in buildings but also reduce costs.

Register now and be among the first to hear about the next milestone on the path to better indoor air quality!



reddot winner 2022

→ Register now  
[belimo.com](https://www.belimo.com)





# CIBSE TM54: 2022 – A UK perspective on evaluating operational energy use at the design stage



**DEJAN MUMOVIC**  
 PhD CEng FCIBSE FIBPSA  
 Professor of Building Performance Analysis,  
 University College London, CIBSE's  
 representative on REHVA's Publication and  
 Marketing Committee  
 d.mumovic@ucl.ac.uk

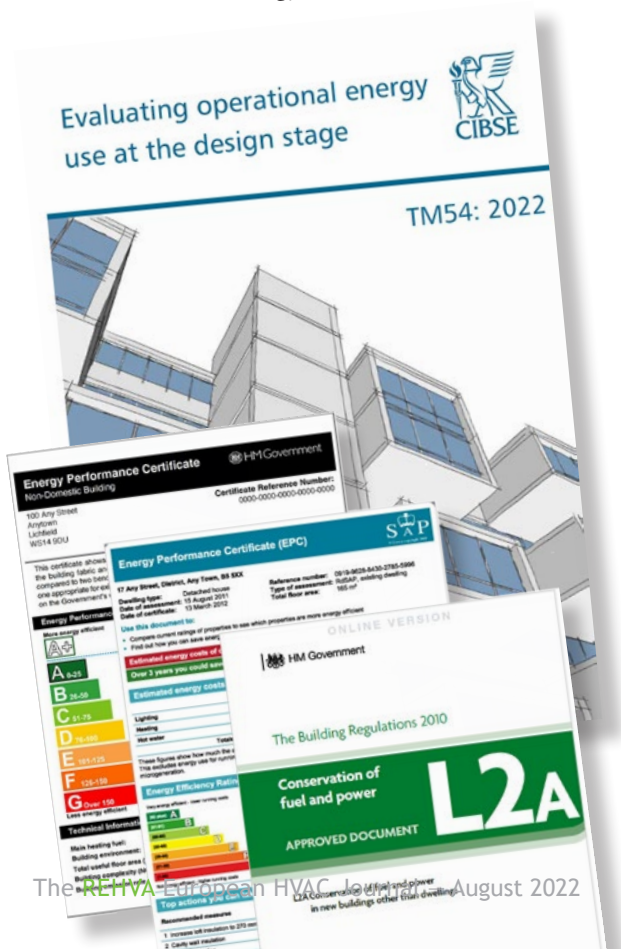
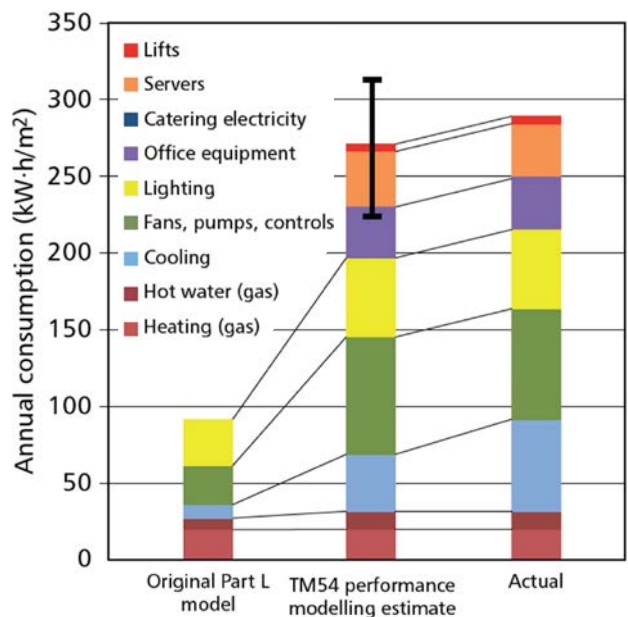
**NISHESH JIAN**  
 PhD, University  
 College London

**ESFAND BURMAN**  
 PhD CEng MCIBSE,  
 University College  
 London

The Chartered Institution of Building Services Engineers (CIBSE) Technical Memorandum 54 provides building designers and owners with guidance on how to evaluate operational energy use once a building's design has been developed. First published in 2013, this was one of the first pieces of industry guidance documents in the UK to talk about and address two major design stage modelling issues:

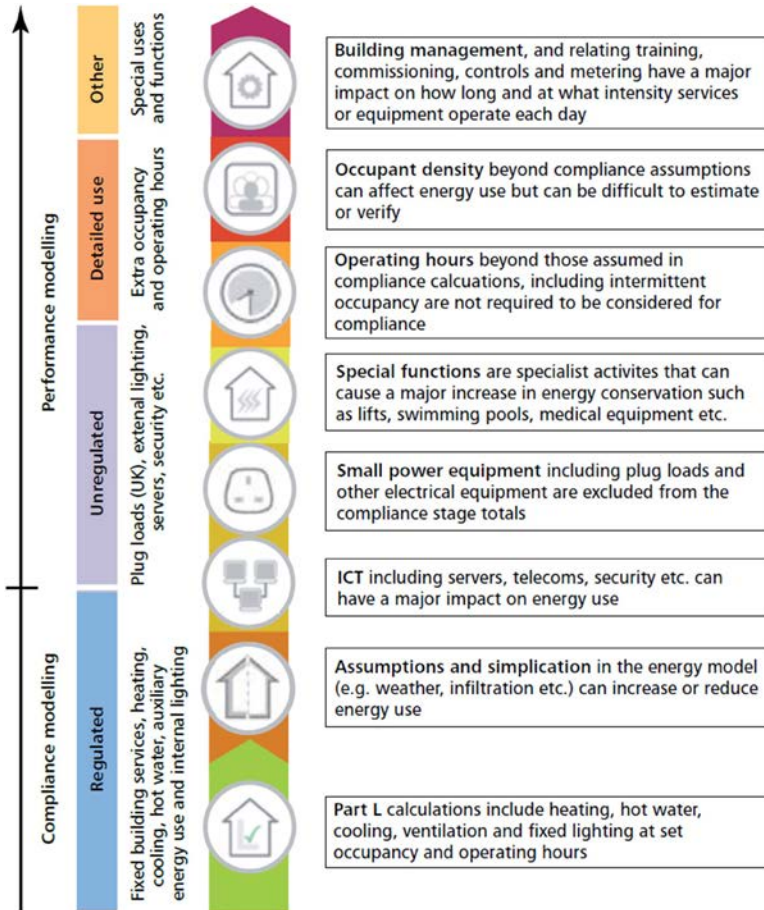
- the performance gap phenomenon where buildings use more energy than the designers thought they would, and
- mistaken interpretation of compliance modelling results, which don't include all end uses and are based on standardised assumptions, and as projection of actual energy use.

In the recently published revision to CIBSE TM54: 2022, the guidance document has been made up to date by taking account of regulatory changes and advances in best practice. The main drivers in revising this best practice modelling guidance were to incorporate the transition of buildings designs towards net-zero, increasing use of contractual performance targets, advances in HVAC modelling and regulations in the UK requiring energy forecasts.





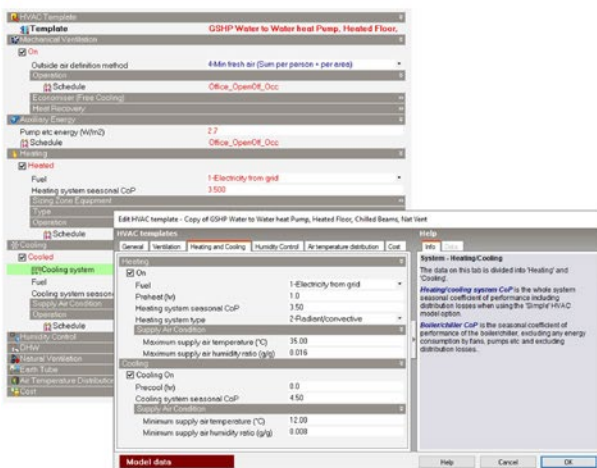
including dynamic simulation with HVAC systems. It also incorporates more detailed guidance around risks, target setting, scenario testing and sensitivity analysis. Some of the important aspects described in TM54 are relating to of modelling, setting the targets, informing the design and testing the results are discussed below.



To optimise the modelling effort and level of detail of modelling calculations and results, project specific conditions can determine the modelling approach and HVAC system modelling details. In cases where there the systems are simple and have limited interaction with each other, and their performance does not vary significantly with demand or hourly external weather then Quasi-steady state, spreadsheet-based tools, and approaches such as Passive House Planning Package (PHPP) can be sufficient. However dynamic simulation tools, such as DesignBuilder Software using EnergyPlus engine, are required for detailed modelling of the building, its fabric, HVAC services and controls, to reflect the modelled operational energy usage of the building more accurately under expected conditions, hour by hour over a year. The HVAC system modelling in these tools can then use Simple HVAC, a simplified loads driven modelling approach, or Detailed HVAC, a full detailed component level modelling to inform the calculations of the energy used by HVAC plant. Detailed HVAC simulation is common in Australia for buildings seeking a NABERS Energy Commitment Agreement and in the USA through ASHRAE Standard 90.1 modelling (Appendix G). Detailed HVAC modelling is expected to become more common in the UK in the context of NABERS UK Design for Performance (DfP) Agreements.

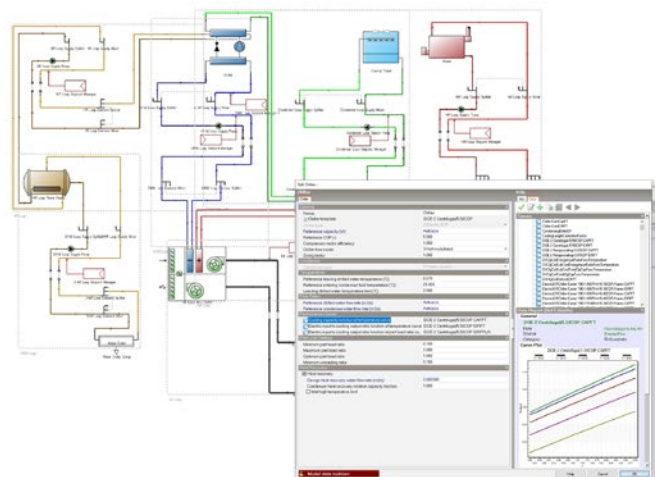
Contractual performance targets have been shown to be a powerful way of delivering performance in practice. Committing to such targets requires engineers to carefully consider the risks and implications, including their scope and appointment, and the modelling that will be required. Similarly, where accurate estimations

Template HVAC

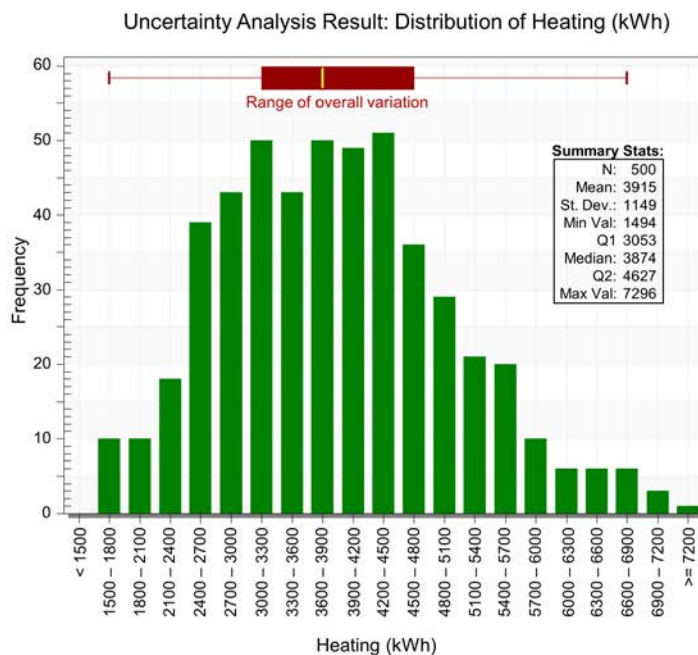
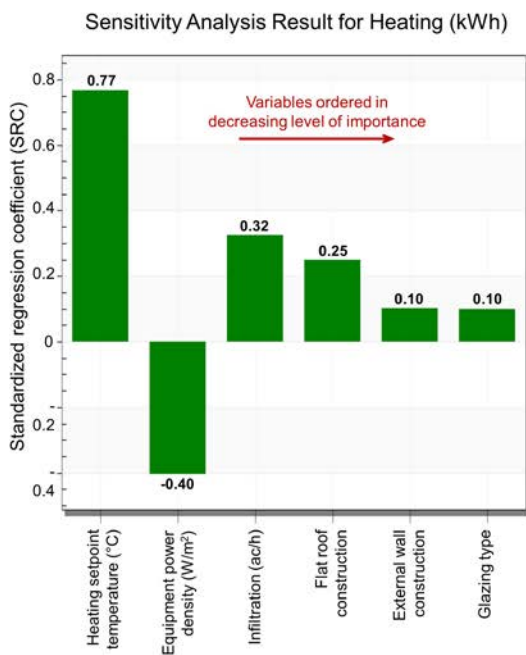


Loads and CoP based HVAC energy calculations

Detailed HVAC



Component level modelling with performance curves for HVAC energy calculations



are being pursued using more advanced methods such as the NABERS UK Design for Performance process, a management strategy to limit such risks is necessary. A risk assessment can be done using a systematic approach of sensitivity and scenario analysis. TM54 sensitivity analysis enables detailed risk assessment by assessing the impact of input parameters on calculation results to identify which inputs (and their uncertainty) are most important and influential. Additionally, all models are expected to be stress tested via scenario analysis, also be referred to as uncertainty analysis where total variability in the calculation results is quantified due to uncertainties in the model inputs.

This TM54 was revised under conditions where there is a growing movement across the industry to meet net zero targets. This requires synergy between policy level frameworks at local body levels and these methodological guidance documents. In this regard, TM54 has been created in such a way that it is aligned with net zero performance targets and related design guidance such as the modelling guidance by the ‘The London Energy Transformation Initiative’, LETI. LETI, a network of built environment professionals, actively works to drive policy level changes to support the transition of the London’s built environment to meet Net Zero Carbon targets. Soon to be published LETI modelling guide provides guidance on what design stage modelling needs to be undertaken so that buildings meet the LETI Energy Use Intensity (EUI) targets in-use. LETI guidance, focused on EUI and other performance aspects of overheating limits and unmet hours supports TM54 methodology as good practice for performance targets covering all end uses with robust scenario and sensitivity testing.

While the main guidance focuses on design stage actions, regularly reviewing the energy performance of any building once it is occupied is a vital element in achieving and maintaining high levels of performance. Therefore, last section of TM54 focuses on a holistic Post Occupancy Evaluation, referring to detailed guidance on assessing the performance of buildings during the operational stage provided in CIBSE TM61–

64. This series of CIBSE TMs on operational performance of buildings provide insights into the problem of the performance gap, its key contributing factors, and steps for a holistic investigation following an integrated approach to energy and indoor environmental quality. ■

### References

1. CIBSE (2022) Evaluating operational energy use at the design stage CIBSE TM54:2022 (London: Chartered Institution of Building Services Engineers) <https://www.cibse.org/knowledge-research/knowledge-portal/tm54-evaluating-operational-energy-use-at-the-design-stage-2022>.
2. NABERS UK (2021) Example Simulation Report Version 1.0 (Watford: Building Research Establishment (BRE)) (available at [https://files.bregroup.com/nabers/NABERS\\_UK\\_Example\\_Simulation\\_report.pdf](https://files.bregroup.com/nabers/NABERS_UK_Example_Simulation_report.pdf)) (accessed 10.01.22).
3. LETI: <https://www.leti.london/>.
4. CIBSE (2020) Operational performance of buildings CIBSE TM61 (London: Chartered Institution of Building Services Engineers).



SAVE THE DATE



## REHVA - EPEE high-level EUSEW policy session on Zero Emission Buildings



28 September 2022, 14:30 - 16:00



Brussels and online



Folker Franz

Director General,  
EPEE



Ciarán Cuffe

Member of European  
Parliament (Greens/EFA,  
Ireland)



Stefan Moser

Head of Unit, European  
Commission Directorate  
General for Energy, Unit B2,  
Buildings and Products



Andrea Vallejo Galarza

EPEE President, Vice-President  
and General Manager  
Johnson Controls



Coen Van De Sande

AREA President, Director  
NVKL



Johann Zirngibl

REHVA Vice-President

Join us for the seminar during the **European Sustainable Week** organized by **REHVA** together with **EPEE**, **EPB Center** and **AREA**.

The session will demonstrate the various elements needed to successfully implement the ZERO EMISSION BUILDING concept across the various climate zones of Europe, bringing together the perspectives of the EU institutions with the HVAC designers, manufacturers and installers and building professionals representing the whole value chain of efficient and renewable HVAC technologies from design to operation and maintenance.

This event is hybrid, register now: <https://www.eusew.eu/>

# Exhibitions, Conferences and Seminars in 2022

## Conferences and fairs 2022

### September

16-19 Sep 2022	ROOMVENT 2022 (roomvent2022.com)	Xi'an, China
26-30 Sep 2022	European Sustainable Energy Week (eusew.eu)	Brussels, Belgium

### October

02-06 Oct 2022	Light + Building 2022 (light-building.messefrankfurt.com)	Frankfurt am Main, Germany
5-6 Oct 2022	42 AIVC Conference (aivc.org)	Rotterdam, the Netherlands
11-13 Oct 2022	Chillventa (chillventa.de)	Nuremberg, Germany
20-21 Oct 2022	The Fifth International Conference on Efficient Building Design (ashrae.org)	Beirut, Lebanon

### November-December

3 Nov 2022	Climatization Days	Lisbon, Portugal
30 Nov - 2 Dec 2022	53rd International HVAC&R Congress and Exhibition (kgh-kongres.rs)	Belgrade, Serbia
8-10 Dec 2022	REFCOLD India 2022 (refcoldindia.com)	Mahatma Mandir, Gandhinagar, Ahmedaba India

## Seminars 2022

20 Sep 2022	EUSEW extended session-Making building performance assessment transparent & holistic: ensuring a reliable and level playing field (rehva.eu)	Online
28 Sep 2022	EUSEW session-Zero Emission Buildings: Climate neutral heating and cooling from Nuorgam to Rizokarpaso (eusew.eu)	Brussels, Belgium
5 Oct 2022	REHVA seminar at Light + Building 2022: BIM Interoperability	Frankfurt am Main, Germany

## Conferences and fairs 2023

### February

4-8 Feb 2023	2023 ASHRAE Winter Conference (ashrae.org)	Atlanta, Georgia USA
--------------	--	----------------------

### March

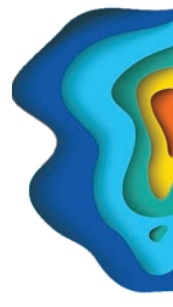
13-17 Mar 2023	ISH 2023 (ish.messefrankfurt.com)	Frankfurt am Main, Germany
14-16 Mar 2023	ACREX 2023 (acrex.in)	Mumbai, India

Due to the COVID19 circumstances, the dates of events might change. Please follow the event's official website



Organised By

**ISHRAE**<sup>®</sup>



# REFCOLD INDIA

**08 - 10 DECEMBER, 2022**  
**Mahatma Mandir, Gandhinagar,**  
**Gujarat, INDIA**



## South Asia's Largest Exhibition & Conference on Refrigeration & Cold Chain Industry Solutions

**SUPPORTED BY**



Exhibition Partner

**Radeecal**<sup>®</sup>  
communications

For Stall Booking & Sponsorship : +91 97270 52028 | [mktg@refcold.in](mailto:mktg@refcold.in) | [www.refcold.in](http://www.refcold.in)

messe frankfurt

**light+building**  
autumn edition

**2.–6.10.2022**  
Frankfurt am Main



# Breaking new ground

International, connected, future-oriented: Light + Building sets new benchmarks – live, in person and digital.

The world's leading trade fair for  
lighting and building services technology





# Innovative impulses for building technology at Light + Building and ISH

Constant innovation is an integral part of the planning, construction, maintenance and further development of buildings and urban infrastructures. Solutions for modern building technology are presented in particular by exhibitors at the two leading international trade fairs Light + Building and ISH. The restart of the lighting and building services technology sector will take place with the Light + Building Autumn Edition in Frankfurt from 2 to 6 October 2022.

More than 1,300 exhibitors from 46 countries are already lined up for the special autumn edition. They will provide a broad overview and insight into the topics of lighting, electrical engineering, home and building automation and security technology. The international meeting place thus offers participants from architecture, planning and the trades an interdisciplinary exchange about the latest developments, innovative solutions and current design trends.

Johannes Möller, Head of Brand Management at Light + Building, explains how the industry is positioned

at Light + Building Autumn Edition: “The Building sector is very strong in the West Grounds. Particularly against the backdrop of the necessary digitalisation and electrification to achieve climate targets, the importance of the range is growing. All the key players are here. In the lighting sector, one or two large companies are missing, but foreign companies in particular are taking advantage of the opportunity to present themselves. As a result, lighting has a very international representation and is still the larger of the two sectors. More than 60 percent of the exhibitors belong to the lighting sector. This shows us how much companies need the trade

## EVENTS UPCOMING

fair venue to generate coverage for themselves. For them, it's a great opportunity to position themselves perfectly and generate a whole new level of attention."

As a supplement to the physical trade fair in Frankfurt, the digital platform Light + Building Digital Extension from 2 to 14 October 2022 will for the first time offer new opportunities for networking, knowledge exchange and encounters. The additional offer helps to expand one's own circle of contacts in a targeted manner via AI-supported match-making. The platform also offers more independence from time and place: Exhibitors can offer product presentations via video streaming and get in touch with customers digitally. In addition, all participants have the opportunity to find out about the Light + Building programme items on-demand following the live event.

### Interdisciplinary offer

In the Smart Home and Smart Building, the bundling of all technical trades through building automation plays an important role. It is represented in Halls 9, 11 and 12. In these halls, visitors will also find energy-efficient building system solutions, electrical installations, electrical installation and network technology and electrical engineering.

An integral part of modern building technology is also the subject of connected security. As a result, Light + Building is bundling the range of products and services on this subject for the first time in the Intersec Building section in Hall 8.0, where the themes of video technology and access control are equally present as data



and fire protection. In the immediate vicinity, the Intersec Forum from 3 to 6 October 2022 will enrich the product range with an exciting congress programme.

Hall 8 forms the transition to the lighting area, as manufacturers of technical lighting components, light sources and control systems are also represented here. Light in all its facets is then the focus in Halls 3, 4 and 6, where the range includes design-oriented luminaires in all styles, technical luminaires, outdoor and street lighting, emergency and safety lighting and full product ranges.

### Highlight: Building Plaza in Hall 9.0

On the first and second day of the fair, the Building Plaza in Hall 9.0 is all about the energy transition. The lecture program ranges from "Power for Mobility" to the installation of photovoltaic systems, energy storage and distribution, charging management and the installation of wall boxes.

Energy-efficient building and renovation will be the topic on Tuesday, 4 October 2022, when the Energy Consultants' Day will be held at the Building Plaza. This will be followed on 5 October 2022 by a seminar organized by REHVA, the Federation of European Heating, Ventilation and Air Conditioning Associations.

The 7th Architects' Forum will feature lectures on the intelligent technology with which the skilled trades can equip smart buildings. It will be held at the Building Plaza on Thursday, 6 October 2022 and will conclude with a visit, including a guided tour, of the E-Haus powered by Light + Building of the ZVEH in Hall 11.0. Architects can receive six continuing education points for participation. Pre-registration with ZVEH at [www.zveh.de/architektenforum](http://www.zveh.de/architektenforum) or [architektenforum@zveh.de](mailto:architektenforum@zveh.de).

### Outlook to ISH 2023

Future-oriented topics such as the conservation of resources and the use of renewable energies will then once again be in focus from 13 to 17 March 2023. The world's leading trade fair for HVAC + Water is the world's largest showroom for modern bathroom concepts and the leading showcase for innovative building solutions. The motto of the 2023 event is "Solutions for a Sustainable Future".

Further current information about Light + Building at [www.light-building.com](http://www.light-building.com) and for ISH at [www.ish-messefrankfurt.com](http://www.ish-messefrankfurt.com). ■





ATIC vzw—asbl – Belgium  
[www.atic.be](http://www.atic.be)



BAOVK – Bulgaria  
[www.baovk.bg](http://www.baovk.bg)



STP – Czech Republic  
[www.stpcr.cz](http://www.stpcr.cz)



DANVAK – Denmark  
[www.danvak.dk](http://www.danvak.dk)



EKVÜ – Estonia  
[www.ekvy.ee](http://www.ekvy.ee)



FINVAC – Finland  
[www.finvac.org](http://www.finvac.org)



AICVF – France  
[www.aicvf.org](http://www.aicvf.org)



VDI-e.V. – Germany  
[www.vdi.de](http://www.vdi.de)



ÉTÉ – Hungary  
[www.eptud.org](http://www.eptud.org)



MMK – Hungary  
[www.mmk.hu](http://www.mmk.hu)



AiCARR – Italy  
[www.aicarr.org](http://www.aicarr.org)



LATVIJAS SILTUMA, GĀZES UN ŪDENS  
 TEHNOLOĢIJAS INŽENIERU SAVIENĪBA

AHGWTel/LATVAC – Latvia  
[www.lsgutis.lv](http://www.lsgutis.lv)



LITES – Lithuania  
[www.listia.lt](http://www.listia.lt)



AIIRM – Republic of Moldova  
[www.aiirm.md](http://www.aiirm.md)



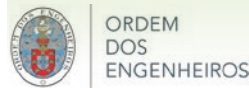
TVVL – The Netherlands  
[www.tvvl.nl](http://www.tvvl.nl)



NEMITEK – Norway  
[www.nemitek.no](http://www.nemitek.no)



PZITS – Poland  
[www.pzits.pl](http://www.pzits.pl)



ORDEM DOS ENGENHEIROS – Portugal  
[www.ordemengenheiros.pt](http://www.ordemengenheiros.pt)



AFCR – Romania  
[www.criofrig.ro](http://www.criofrig.ro)



AGFR – Romania  
[www.agfro.ro](http://www.agfro.ro)



AIIR – Romania  
[www.aiiro.ro](http://www.aiiro.ro)



KGH c/o SMEITS – Serbia  
[www.smeits.rs](http://www.smeits.rs)



SSTP – Slovakia  
[www.sstp.sk](http://www.sstp.sk)



SITHOK – Slovenia  
<https://web.fs.uni-lj.si/sithok/>



ATECYR – Spain  
[www.atecyr.org](http://www.atecyr.org)



SWEDVAC – Sweden  
[www.energi-miljo.se](http://www.energi-miljo.se)



DIE PLANER – Switzerland  
[www.die-planer.ch](http://www.die-planer.ch)



TTMD – Turkey  
[www.ttmd.org.tr](http://www.ttmd.org.tr)



CIBSE – United Kingdom  
[www.cibse.org](http://www.cibse.org)

# SUPPORTERS

*Leaders in Building Services*



Daikin Europe – Belgium  
[www.daikin.eu](http://www.daikin.eu)



EPEE – Belgium  
[www.epeeglobal.org](http://www.epeeglobal.org)



EVIA – Belgium  
[www.evia.eu](http://www.evia.eu)



Velux – Denmark  
[www.velux.com](http://www.velux.com)



Granlund – Finland  
[www.granlund.fi](http://www.granlund.fi)

**Halton**

Halton – Finland  
[www.halton.com](http://www.halton.com)

**uponor**

Uponor – Finland  
[www.uponor.com](http://www.uponor.com)



Eurovent Certita Certification –  
 France  
[www.eurovent-certification.com](http://www.eurovent-certification.com)



LG Electronics – France  
[www.lgeaircon.com](http://www.lgeaircon.com)



Viega – Germany  
[www.viega.com](http://www.viega.com)



Aermec – Italy  
[www.aermec.com](http://www.aermec.com)



Evapco Europe – Italy  
[www.evapco.eu](http://www.evapco.eu)



Rhoss – Italy  
[www.rhoss.com](http://www.rhoss.com)

**PURMO**  
 GROUP

Purmo Group – The Netherlands  
[www.purmogroup.com](http://www.purmogroup.com)



Royal Haskoning DHV –  
 The Netherlands  
[www.royalhaskoningdhv.com](http://www.royalhaskoningdhv.com)

**SMAY**

SMAY – Poland  
[www.smay.eu](http://www.smay.eu)



E.E.B.C. – Romania  
[www.eebc.ro](http://www.eebc.ro)



Dosetimpex – Romania  
[www.dosetimpex.ro](http://www.dosetimpex.ro)



Testo – Romania  
[www.testo.com](http://www.testo.com)



Camfil – Sweden  
[www.camfil.com](http://www.camfil.com)

**FläktGroup**

Fläkt Group – Sweden  
[www.flaktgroup.com](http://www.flaktgroup.com)



Lindab – Sweden  
[www.lindab.com](http://www.lindab.com)

**Swegon**

Swegon – Sweden  
[www.swegon.com](http://www.swegon.com)



Systemair – Sweden  
[www.systemair.com](http://www.systemair.com)

**BELIMO**

Belimo Automation – Switzerland  
[www.belimo.com](http://www.belimo.com)

**Arçelik**

Arçelik – Turkey  
[www.arcelikglobal.com](http://www.arcelikglobal.com)



Friterm Termik Cihazlar  
 Sanayi ve Ticaret – Turkey  
[www.friterm.com](http://www.friterm.com)

## REHVA Associate Organisations:



Enerbrain srl – Italia  
[www.enerbrain.com](http://www.enerbrain.com)



Envirotech – United Kingdom  
[www.envirotech.co.uk](http://www.envirotech.co.uk)



ISIB – Turkey  
[www.isib.org.tr](http://www.isib.org.tr)



ECI – Belgium  
[copperalliance.org](http://copperalliance.org)



OAER – Romania  
[www.oaer.ro](http://www.oaer.ro)

Network of 26 European HVAC Associations joining 120 000 professionals

REHVA Office: Rue Washington 40, 1050 Brussels - Belgium • Tel: + 32 2 514 11 71 - info@rehva.eu - www.rehva.eu

# THINK PERFORMANCE

## THINK...SUSTAINABILITY

## THINK...FUTURE







**Eurovent certified products**  
for sustainable and energy  
efficient buildings & homes.



### Visit our new website



-  Find & compare certified products
-  Download full performance reports
-  Verify product certificate validity
-  Read & share our articles & news



[www.eurovent-certification.com](http://www.eurovent-certification.com)





NEW  
NEW  
NEW  
NEW  
NEW  
NEW  
NEW  
NEW  
NEW  
NEW  
NEW  
NEW  
NEW  
NEW  
NEW  
NEW  
NEW  
NEW  
NEW  
NEW  
NEW



EUROPEAN  
GUIDEBOOK



**Energy Efficient  
Renovation of  
Existing Buildings for  
HVAC professionals**

NO. 32 - 2022

Federation of European Heating, Ventilation and Air Conditioning Associations

**NEW GUIDE  
BOOK**