

# The REHVA European HVAC Journal

Volume: 57

Issue: 4

August 2020

www.rehva.eu

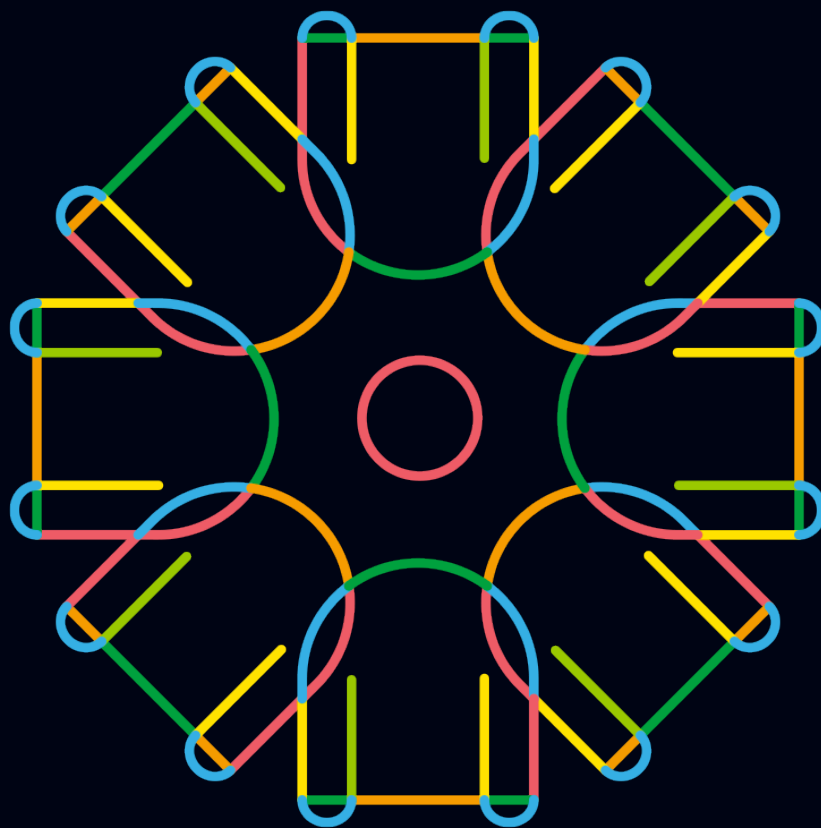

## Special issue

# ALDREN

Alliance  
for Deep RENovation  
in buildings

- Focus on Eastern Europe
- COVID-19: Ventilation systems to reduce the risks of contaminated aerosols

The ALDREN project has received funding from the European Union's Horizon 2020 research and innovation programme under grant agreement No. 754159. The sole responsibility for the content of this project lies with the authors. It does not necessarily reflect the opinion of the European Commission. The EC is not responsible for any use that may be made of the information it contains.



# HVAC PROFESSIONAL

Choose REHVA Journal for your  
advertisement campaign

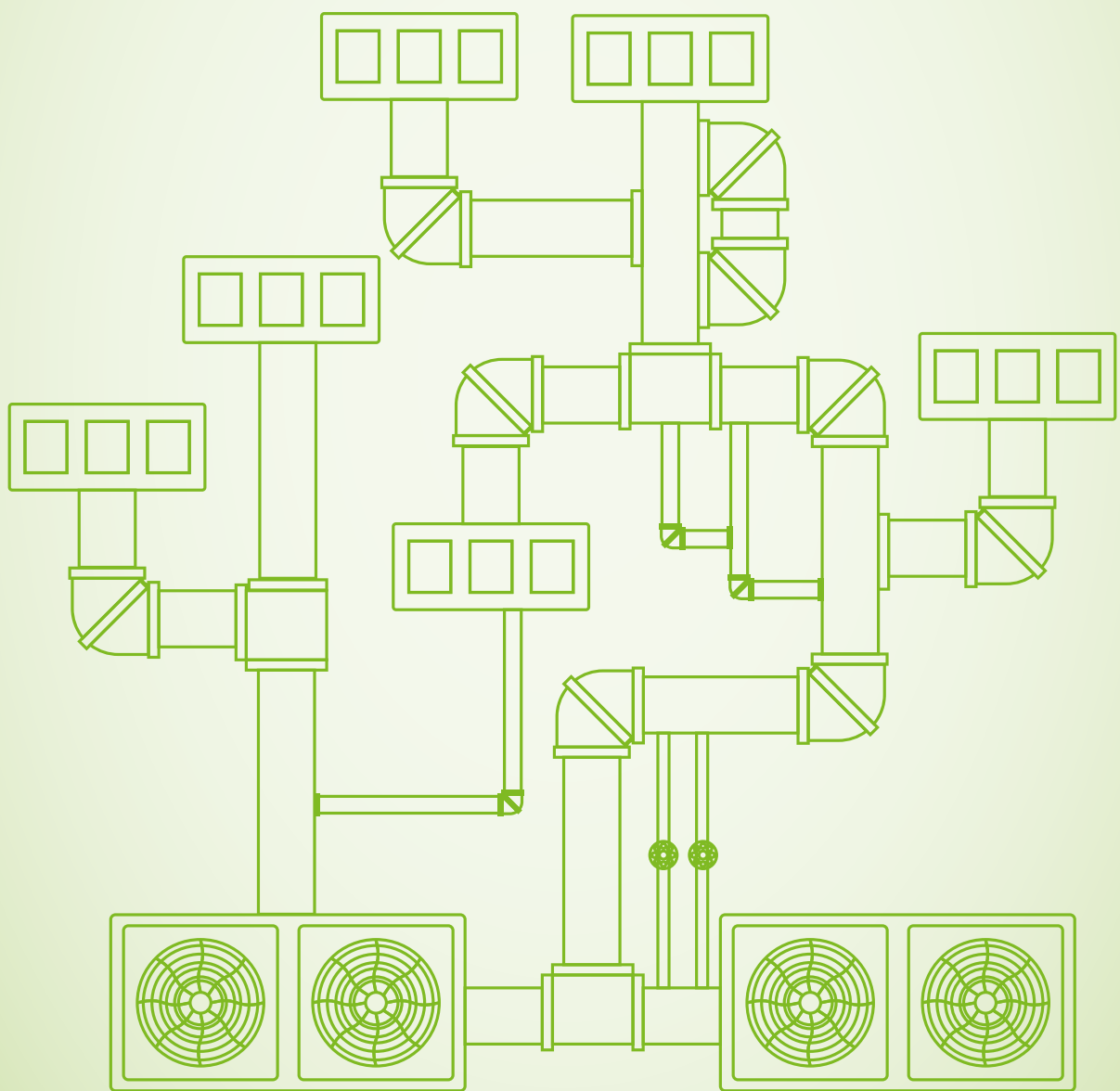

Contact: Nicoll Marucciova, [nm@rehva.eu](mailto:nm@rehva.eu)

**Editor-in-Chief:** Jaap Hogeling  
jh@rehva.eu

**Associate Editor:** Stefano Corgnati, Italy  
stefano.corgnati@polito.it

**Editorial Assistant:** Nicoll Marucciová,  
nm@rehva.eu

**General Executive:** Ismail Ceyhan, Turkey

#### REHVA BOARD

**President:** Frank Hovorka

#### Vice Presidents:

Atze Boerstra  
Manuel Carlos Gameiro da Silva  
Catalin Lungu  
Ivo Martinac  
Kemal Bayraktar  
Juan Travesi

#### EDITORIAL BOARD - 2020

Francis Allard, France  
Ahmet Arisoy, Turkey  
Marianna Brodatch, Russia  
Vincenc Butala, Slovenia  
Stefano P. Corgnati, Italy  
Francesca R. d'Ambrosio, Italy  
Ioan Silviu Dobosi, Romania  
Andy Ford, United Kingdom  
Jaap Hogeling, the Netherlands  
Karel Kabele, Czech Republic  
Jarek Kurnitski, Estonia  
Livio Mazzarella, Italy  
Renato Merati, Italy  
Birgit Müller, Germany  
Natasja Nord, Norway  
Branimir Pavkovic, Croatia  
Dusan Petras, Slovakia  
Olli Seppänen, Finland  
Branislav Todorovic, Serbia  
Peter Wouters, Belgium

#### ADVERTISEMENTS

Nicoll Marucciová, nm@rehva.eu

#### SUBSCRIPTIONS and CHANGES OF ADDRESSES

REHVA OFFICE:  
Washington Street 40  
1050 Brussels, Belgium  
Tel: +32-2-5141171  
info@rehva.eu, www.rehva.eu

#### PUBLISHER

TEKNİK SEKTÖR YAYINCILIĞI A.Ş.  
Barbaros Mahallesi, Uğur Sk. No: 2/2  
Üsküdar/Istanbul, Turkey

REHVA Journal is distributed in over 50 countries through the Member Associations and other institutions. The views expressed in the Journal are not necessarily those of REHVA or its members. REHVA will not be under any liability whatsoever in respect of contributed articles.

Cover photo: ALDREN

## Contents

Download the articles from [www.rehva.eu](http://www.rehva.eu) -> REHVA Journal

### EDITORIAL

- 4 COVID-19 and the third route**  
Jaap Hogeling

### ARTICLES

- 5 ALDREN – A voluntary and modular European framework to support Deep Renovation in the Building sector**  
Olivier Greslou, Johann Zirngibl & Matthieu Rivallain
- 9 Interview with Alexander Hadzhiivanov (EBRD)**
- 11 European Common Voluntary Certification Scheme and energy ratings**  
Jana Bendžalová
- 18 Closing the energy gap in renovations of offices and hotels**  
Robert Cohen, Greg Waring & Saadia Ansari
- 22 Application of ALDREN-TAIL index for rating the indoor environmental quality of buildings undergoing deep energy renovation**  
Wenjuan Wei, Corinne Mandin & Pawel Wargocki
- 26 Linking ALDREN's energy and IEQ performance assessments to financial value of buildings**  
Olivier Greslou & Jana Bendžalová
- 31 Interview with Chayma Oueslati (Cushman & Wakefield)**
- 35 The ALDREN Building Renovation Passport for Non-Residential buildings: a modular digital instrument to support the Renovation Wave**  
Marta Maria Sesana, Graziano Salvalai, Simon Ligier & Mathieu Rivallain
- 42 Implementing ALDREN outcomes in the renovation market: interviews with Patrick Nossent (CERTIVEA), Mayte García Córcoles (HOSBEC) and Isabel de los Ríos Rupérez (BES offices, IVE Certification Entity)**
- 47 Heat Recovery from Sewer System in a Sport Complex**  
Dominika Macková & Jana Peráčková
- 53 Water Quality and Water Consumption in Apartment Buildings in Slovakia**  
Jana Peráčková, Dominika Macková, Milan Krafčík & Zuzana Čermanová
- 59 Can radiant wall cooling be preferable solution for building retrofit?**  
Michal Krajčík, Dušan Petrás, Ondřej Šikula & Martin Šimko
- 66 Optimal Indoor Air Parameters in Historical Buildings: Determination Technique**  
Iurii A. Tabunshchikov, Marianna Brodach & Nikolai Shilkin
- 72 Impact of groundwater quality on heat pump operation**  
Milan Mitrić
- 80 The application of sorption rotors in the air drying technology**  
Aleksandar Pjević
- 85 Air-Conditioning of the Laboratory for Testing of Samples for the Coronavirus Called "Fiery Eye"**  
Dejana Soldo
- 88 Combined actions of HVAC professionals against Corona and climate crises**  
Miodrag Mesarović
- 93 ECOROBOT for total cleaning & destruction of microorganisms on air-obstructed HVAC'S internal surfaces**  
Boriša Milekić, Dragan Škobalj, Predrag Škobalj & Valentina Turanjanin
- 97 COVID-19: Challenges and opportunities in the district energy sector**  
Greg Gebrail & Bojan Bogdanovic
- 100 Neolepenism – the new thermal comfort construction facilities**  
Nenad B. Miloradović
- 105 H2020 MOBISTYLE project's showcase of the final results**  
Ana Tisov, Jure Vetršek, Dan Podjed & Peter Op 't Veld
- 110 REHVA COVID-19 guidance activities continue**

### EVENTS & FAIRS

- 114 Exhibitions, Conferences and Seminars in 2020 & 2021**

## Advertisers

- ✓ REHVA Journal ..... 2
- ✓ REHVA Members ..... 112
- ✓ REHVA Supporters ..... 113
- ✓ REHVA Guidebooks ..... 116

## Next issue of REHVA Journal

Instructions for authors are available at [www.rehva.eu](http://www.rehva.eu) (> Publications & Resources > Journal Information). Send the manuscripts of articles for the journal to Jaap Hogeling [jh@rehva.eu](mailto:jh@rehva.eu).

# COVID-19 and the third route

Are ventilation systems able to reduce the risk of contaminated aerosols? Do we need to reconsider the current ventilation rates?

As HVAC professionals we care for the indoor environment. Health and comfort for our clients, the people using buildings where they spend more than 80% of their time.

Long debates about the required level of fresh air supply via our ventilation systems reflect our involvement to realise healthy and comfortable indoor environments. The process of finalising in 2019 the EN 16798-1 on indoor environmental input parameters for design and assessment of energy performance of buildings addressing indoor air quality, thermal environment, lighting and acoustics, reflects this. As its scope says this standard specifies amongst others requirements for indoor air quality. At the same time restricting to the criteria for indoor environment that are set by human occupancy. In Annex B of this standard there are tables with recommended values for ventilation. Due to health reasons the total minimum airflow rate during occupancy should never be below 4 l/s per person (14.4 m<sup>3</sup>/h p.p) and the WHO guideline values on chemical and particular matter have to be met.

It is clear that the ventilation systems we realise in buildings for human occupancy are based on comfort requirements (perceived air quality) limiting the CO<sub>2</sub> concentration as human tracer, taking humidity and indoor emissions of some chemicals into account. The given ventilation rates are not based on possible virus transmission via aerosols in the air. The danger to get infected by aerosols containing viruses was never considered. Because we don't know dose effect relations and it is difficult to prove that those aerosols contain active viruses. This last issue seems now more clear. In the New York Times Dr. Lednicky revealed that "We can grow the virus from air – I think that should be the important take-home lesson,"\*. This is supporting the importance of the 3rd route.

The REHVA Taskforce on Covid-19 took this third infection route via aerosols very serious in the guidance paper published August 3rd see: [www.rehva.eu/activities/covid-19-guidance](http://www.rehva.eu/activities/covid-19-guidance). The REHVA Taskforce summarises this as follows: New evidence on SARS-CoV-2 airborne transmission and general recognition of long-range aerosol-based transmission have developed

recently. This has made ventilation measures the most important engineering tool in the infection control. While physical distancing is important to avoid a close contact, the risk of an aerosol concentration and cross-infection from 1.5 m onward from an infected person can be reduced with adequate ventilation and effective air distribution solutions. In such a situation at least three levels of guidance are required: (1) how to operate HVAC and other building services in existing buildings right now during an epidemic; (2) how to conduct a risk assessment and assess the safety of different buildings and rooms; and (3) what would be more far-reaching actions to further reduce the spread of viral diseases in future in buildings with improved ventilation systems.

In Appendix 1 of the REHVA guidelines we say: Ventilation improvement in existing or new buildings brings a question if more outdoor air ventilation needed to reduce the risk of cross-infection? Infection risk is currently not addressed in this standard as design criterion. On the other hand, cross-infection risk is well known and applied in the design of hospital buildings where it leads to ventilation with a 6–12 air change per hour (ACH) rate. Hospital ventilation systems have worked well in COVID-19 conditions as cross-infections have been under control, illustrating that high capacity ventilation is capable to keep aerosol concentration at low level. In non-hospital buildings, there are evidently lower emission rates and smaller numbers of infected persons per floor area. So, a lower ventilation rate than in hospitals, for instance Category I ventilation rate (see EN 16798-1), could be considered as a starting point for the risk reduction. It is also worth noting that 4 l/s per floor m<sup>2</sup> in meeting rooms and classrooms corresponds to 5 ACH and is not much below the air change rate of patient rooms with precautions against airborne risks.

Concluding: Yes, increase of ventilation rates will help to reduce the infection risks, and as this will not be the last epidemic we will encounter, we should reconsider the basis of our ventilation standards. ■



**JAAP HOGELING**  
Editor-in-Chief  
REHVA Journal

\*See: <https://www.nytimes.com/2020/08/11/health/coronavirus-aerosols-indoors.html>.

# ALDREN – A voluntary and modular European framework to support Deep Renovation in the Building sector



**Keywords:** Deep Renovation, holistic approach, international ISO/CEN standards, verified performance, health and well-being, NZEB

**A**LDREN targets and supports investments in deep renovation, encouraging key Building stakeholders to contribute to the “Renovation wave” that has been recently announced in the European Green Deal. To be efficient, the Green Deal will have to be consistent from the political top level to the identification of relevant renovation actions by owners and consultants, investment decisions from the financial sector and application on the field by qualified building professionals. ALDREN proposes a transparent, consistent, common EU wide assessment framework to trigger more ambitious renovation projects through the inclusion of improved sustain-

ability metrics in certifications and the use of decision-support protocols and tools.

### Why ALDREN? Working out a common language to increase energy renovation rates and quality

ALDREN - *Alliance for Deep RENovation in Buildings* - is a European project funded by the European Union in the scope of the Horizon 2020 Research and Innovation Program. Eight European partners [1] are working together to increase the rate and quality of building energy renovations (Figure 1).



Figure 1. The ALDREN Consortium.

This project has received funding from the European Union’s Horizon 2020 research and innovation programme under grant agreement 754159. The sole responsibility for the content of this paper lies with the authors. It does not necessarily reflect the opinion of the European Commission (EC). The EC is not responsible for any use that may be made of the information it contains.



ALDREN has been built on the observation that **nobody can trigger deep renovation alone**, while there is a lack of building retrofits in the EU that incorporate significant and actual improvements in energy performance. The successful implementation of the ambitious European and national energy and environmental renovation objectives will require that the **whole implementation chain, from the legislative level** (the EU institutions), where the objectives are defined, **to the implementation on field by qualified professionals** becomes coherent, consistent, transparent.

ALDREN's overarching aim is therefore to raise confidence in deep energy renovation and prepare the ground for more investment, **answering the needs from key stakeholder groups involved in the renovation implementation chain**. Thereby, ALDREN seeks to overcome main market barriers:

- The lack of a holistic strategy to design, prioritize, finance and implement energy renovation actions over time while energy savings alone rarely trigger renovation projects
- The lack of a strong relationship between key stakeholder groups of the Building sector
- A limited confidence of building professionals and stakeholders in the actual performance and quality of energy-related renovation actions
- Difficulties ensuring a consistent integration of subsequent renovation actions over time

The identified barriers show there is a need for a **common language to be shared between the stakeholders of the implementation chain**. Therefore, the ALDREN approach has been defined and consolidated through a collaboration with main building stakeholders, as described in **Figure 2**.



**Figure 2.** The ALDREN Alliance.

An ALDREN Alliance has been set up to better specify their needs and reflect them in high quality protocols. Interactions between the ALDREN Consortium and the ALDREN Alliance have also allowed to raise awareness on the co-benefits related to deep energy renovation and to the use of harmonized, reliable and transparent European performance ratings and reporting tools.

The ALDREN Alliance has set up an efficient vehicle for future cooperation and communication of stakeholders beyond the project duration.

## What is ALDREN? A modular and flexible methodological framework

ALDREN is a **methodological framework to support decision-making and investment in deep energy renovation of non-residential buildings**. It is voluntary and provides **consistent sustainability metrics** to improve certification of energy and IEQ performance. ALDREN could be used as a whole, but also in a modular approach by each stakeholder of the renovation implementation chain. It is built to ensure a consistent information sharing between stakeholders depending on their needs: common language.

ALDREN's framework is holistic, harmonized and modular (**Figure 3**): it is based on a **set of procedures (modules)** that consist in implementing **step-by-step operational protocols to assess the energy performance, Indoor Environmental Quality (IEQ, related to health & well-being) and financial value of buildings before and after energy renovation**. ALDREN protocols rely on simulations and measurements based on best practice and the **consistent use of CEN and ISO standards to ensure transparency and quality**. ALDREN is also the first integrated common framework for deep renovation that is based on these standards.

As seen in **Figure 3**, the ALDREN framework encompasses the following 4 standalone modules:

- A consistent, harmonized, unique European energy performance rating, based on ISO/CEN standards, offering comparability and transparency across the EU to provide a common metrics and highlight the quality for financial instruments connected with renovation. A rating scale with classes from A-G has been defined to compare and identify in priority the buildings fitting best for deep renovation and to evaluate the impact of renovation actions on energy performance.

- An energy Performance verification framework allowing actual (measured) performance to be compared with simulated (predicted) performance. It encompasses a “Design for Performance” protocol that sets out and tracks the actions required during the deep renovation process. It also includes a “Performance Verification Tool” (PVT) to compare predicted and actual performance at different levels of granularity.
- A health and well-being assessment protocol. It is based on an index called ALDREN-TAIL to rate the Indoor Environment Quality (IEQ) of buildings undergoing deep renovation, focusing on 4 key components: Thermal environment (T), Acoustic environment (A), Indoor air quality (I), Luminous environment (L). TAIL ratings can and should be evaluated before and after renovation.
- A protocol to evaluate impacts of energy and non-energy benefits associated with deep renovation on the financial value and risks of office and hotel buildings. The information and sustainability metrics provided by the 3 previous modules and the Renovation Roadmap of the ALDREN BRP (see below) is shared with financial valuation experts who compare the financial impacts – costs, risks and value – associated with different renovation scenarios.

**ALDREN standalone modules produce a set of indicators that form consistent, holistic sustainability metrics.** Alongside additional information, they are reported in 2 + 1 dedicated and complimentary

**reporting tools** that support directly the EU policies through the implementation of measures defined in the EPBD:

- A European Voluntary Certificate (EVC): providing a synthesis of a building’s energy performance and a summary of the main renovation actions to be undertaken. **The EVC is ALDREN’s back-bone that supports the implementation of a European Voluntary Certification Scheme (EVCS) introduced in Article 11(9) of the EPBD.**[2]

*NB: ALDREN provides the first step to the development of an EVCS with energy performance ratings and harmonized calculation methods to produce a certificate. The development of a certified training program of qualified experts should be the next step that started in H2020 CEN-CE project <https://www.cen-ce.eu/>.*

- An extended version of ALDREN’s EVC which can be called ALDREN’s EVC+: it is the EVC with the addition of several sections to describe the actual (measured) energy performance, IEQ (TAIL-index about health & well-being) and to analyse the impacts of proposed energy renovation actions on financial value.
- Both the EVC and its EVC+ version provide a snapshot of the building’s performance, quality and renovation potential at a given time and gives recommendations for improvement of energy performance with potential reference to detailed Building Renovation Passport to be fully compliant with the require-

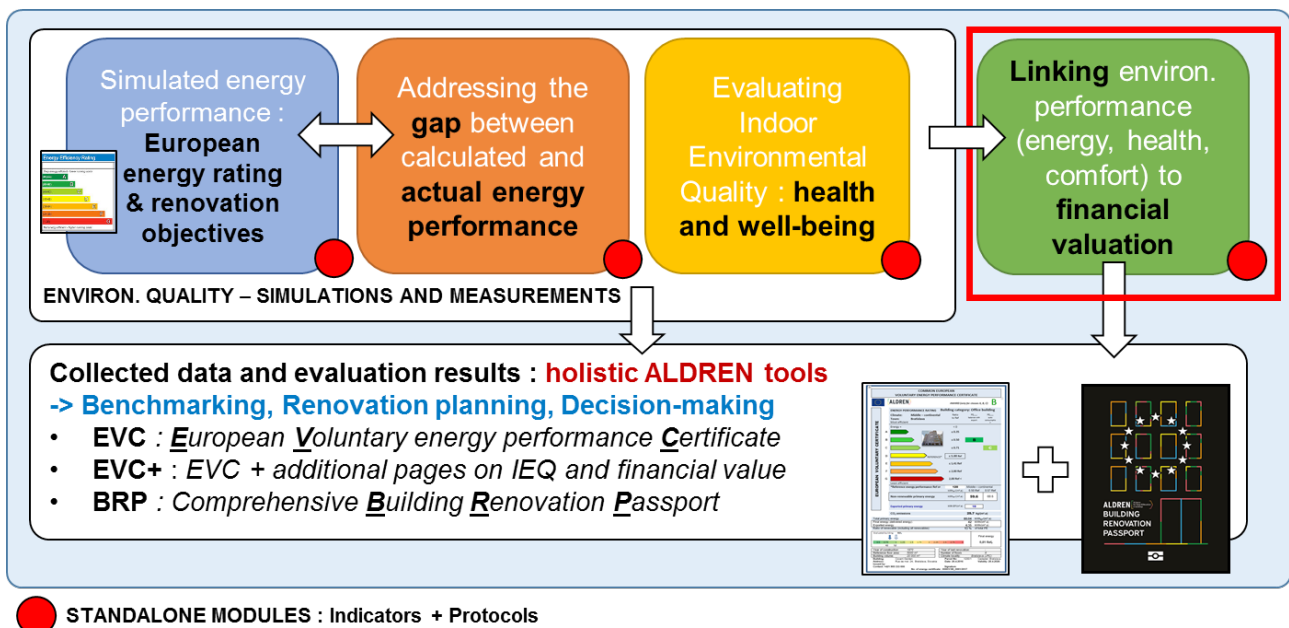

Figure 3. The ALDREN Framework – Standalone assessment modules and holistic reporting tools.

ments on energy performance certificate in EPBD. Their main targets are building owners, banks and investors, European and national political institutions who need to identify a building's performance and renovation potential within a given building stock. ALDREN's sustainability metrics reported in the EVC could be used as eligibility criteria to mobilise private and public financing for deep renovation projects.

- A Building Renovation Passport (BRP): offering a more detailed tool that is complimentary to the ALDREN EVC and EVC+. The BRP is a dynamic instrument to be used and updated over time along the renovation path to deep renovation. It includes: (a) a Logbook where comprehensive collected data better informs building owners and managers about the current technical energy, IEQ and financial performance status of their building and (b) a tailored Renovation Roadmap with one or multiple steps to reach high energy performance in the medium to long term. As with the EVC, the ALDREN BRP supports the implementation of EPBD for non-residential building where the concept has been introduced in Article 19a [3].

In addition, ALDREN allows voluntary certification scheme operators to integrate part of ALDREN standalone modules and metrics into their certifications. Testimonies from IVE Certification Entity and Certivea about the potential uptake of ALDREN elements in BES Oficina and HQE certifications are provided in the following pages.

## What are the main outcomes of ALDREN for building renovation stakeholders?

ALDREN's flexible structure can fulfil the needs of different stakeholder groups allowing:

- To conduct a reliable assessment of the actual current energy performance and indoor environmental quality of a building and provide prediction of future energy performance after implementation of energy related investment
- To benchmark this performance and quality on a European scale, offering comparison with similar building assets within a given building stock or in other European countries.
- To ensure along the deep renovation process that energy and IEQ performance predictions are as realistic as possible, that the construction and commissioning process is true to the design intent, and

to allow the predicted performance to be verified through measurements.

- To identify and prioritize the most relevant renovation actions over time from both a technical and financial perspective, avoiding lock-in effects with a proper planning of main renovation steps.
- To translate the benefits of energy renovation actions on health & well-being and financial value – hence limiting obsolescence risks and increasing attractiveness of renovated building assets.
- To provide consistent and holistic sustainability metrics as eligibility criteria for investment.

## To conclude

The ALDREN framework is a major contribution allowing the Energy performance (EP) assessment of buildings to:

1. Be **comparable** all over Europe,
2. Be **reliable** (expectation should be reach in reality),
3. **Improve health & wellbeing** (indoor air quality, climate change resilient buildings),
4. **Define roadmaps** to nearly Zero Energy Building (nZEB),
5. Favor communication between all involved stakeholders
6. **Provide indicators and common metrics for financial support and risks analysis** to achieve EU climate targets. ■

## References

- [1] Public organizations and universities: CSTB (France), DTU (Denmark), Politecnico Milano (Italy) / Certification bodies: Certivea (France), IVE (Spain) / Building professionals: ENBEE (Slovakia), VERCO (UK), REHVA (Belgium and Europe)
- [2] Article 11(9) states that *"The Commission shall (...) adopt a voluntary common European Union certification scheme for the energy performance of non-residential buildings. (...) Member States are encouraged to recognize or use the scheme, or use part thereof by adapting it to national circumstances."*
- [3] Article 19a of the EPBD describes *"an optional building renovation passport that is complementary to the energy performance certificates, in order to provide a long-term, step-by-step renovation roadmap for a specific building based on quality criteria (...) outlining relevant measures and renovations that could improve the energy performance"*





### Interview with Alexander Hadzhiivanov

Green Economy Specialist, Environmental and Sustainability Department of the EBRD explains the Bank's approach to green and potential links with the ALDREN project.



## Introduction

The fall of the Berlin Wall in 1989 was one of the monumental events, which led to the EBRD's creation.

The European Bank for Reconstruction and Development (EBRD) was established to facilitate transition of the former communist countries in central and Eastern Europe to a free, market-based, competitive and green economy, and to help the region integrate into the new, post-Cold War reality.

### 1. The EBRD has signed €34 billion in green investments. To define what is "green" and eligible for green funding, EBRD has created the Green Economy Transition (GET) handbook. What are the key points of the definition of green in the GET handbook related to building developments?

– The EBRD GET Handbook reflects general provisions of the Multinational Development Banks (MDBs) Climate Finance Methodology. The latter provides a set of general definitions and guidelines as well as a list of eligible activities that allow identifying, tracking and consistent accounting and reporting of financial flows identified as climate finance. The Joint MDB Methodology has been developed by the Joint Climate Finance Tracking Group of Multilateral Development Banks (MDBs) [1] based on their experience and knowledge of climate activities and available best practice low-carbon technologies. It is still a work in progress, being further refined and amended with the aim of providing a higher-level methodological guidance in the area of climate finance. These higher-level principles are further defined by each individual MDB into own operational policies, requirements and processes, in order to reflect specific characteristics of the markets in which the given MDB operates. The EBRD GET Handbook converts the general principles of the Joint MDB Climate Finance Methodology into practical and operational policies to be applied by

The Bank has since played a historic role and gained unique expertise, investing more than €145 billion in more than 5,700 projects in nearly 40 countries from central Europe to central Asia and the southern and eastern Mediterranean.

Safeguarding the environment and a commitment to sustainable energy have also always been central to the EBRD's activity. More recently, the Green Economy Transition approach has made climate finance a key measure of the Bank's performance.

the Bank. The following main criteria are at the core of the EBRD GET Handbook:

- Supporting activities that advance the transition to an environmentally sustainable, low-carbon and climate-resilient economy
- Preventing economies from being locked into carbon-intensive, climate-vulnerable and/or environmentally damaging pathways
- Enhancing innovation
- Broadening the environmental dimensions of investment, from projects in sustainable energy and resource (water and materials) efficiency to all other types of projects that result in net physical environmental benefits
- Mobilising and scaling-up the use of private and public financing channels.

### 2. What are the financial advantages for a building owner to be GET eligible? Do the advantages only apply to the loan or does GET also recognise a higher asset value of green buildings?

– Advantages of making an asset GET-compliant means that for the owner:

- The building is energy and resource efficient, with lower operation costs, including but not limited to lower utility bills

[1] The MDBs involved are African Development Bank; the Asian Development Bank; the Asian Infrastructure Investment Bank; the European Bank for Reconstruction and Development; the European Investment Bank; the Inter-American Development Bank Group; the Islamic Development Bank; and the International Bank for Reconstruction and Development, International Development Association, International Finance Corporation, and Multilateral Investment of the World Bank Group.

- The building will use state of the art, reliable, and environmentally friendly technologies, which will ensure better quality of the environment, and potentially higher productivity of activities conducted in such building
- Lower regulatory and compliance risks related to any future amendments of technical and environmental regulations
- Potentially easier access for funding and better financing terms due to lower risks as described above
- Potentially higher asset value and better position on the market in the future, taking into account that current market development more and deeper reflects environmental liabilities associated with any economic activities and investments

We do not yet fully reflect all of these advantages in our credit and risk assessment models. However, we do follow external expert discussions and policy development across the EU and will incorporate them soon into our standard financing models.

**3. In Annex 5.2 of the GET finance for building developments, activities are eligible for GET if they reach LEED-Silver or BREEAM-GOOD. Do you think that the ALDREN certification, which is based on applicable EU standards, could also satisfy the eligible criteria of GET, and if yes what is the procedure that ALDREN is officially recognised by EBRD?**

– Actually, we are in the process of amending our requirements for GET eligible investments in buildings in order to reflect the introduction of the EU NZEB requirements as well as the provisions of the EU Taxonomy. We do further accept credible international certification schemes above a certain threshold (i.e. BREEAM Very Good, LEED-Gold, DGNB-Silver, the new net zero carbon version of the EDGE, etc) and in general by any other certification method with a sufficient level of ambition, using credible and comprehensive methodology and operated with integrity. We do believe ALDREN is a much needed, practical model, which meets all of our formal criteria. For these reasons, we would be very happy to consider ALDREN as GET eligible in the upcoming amended version of the EBRD GET Handbook.

## HVAC Commissioning Process

### REHVA EUROPEAN GUIDEBOOK No.27

This Guidebook describes the HVAC Commissioning Process compatible with the routines in the building sector almost everywhere around the world. This is the first work that both describes the process in a very hands-on manner and details the commissioning activities for various types of systems, complete with theoretical background, guidance & checklists.

## Quality Management for Buildings

### REHVA EUROPEAN GUIDEBOOK No.29

This guidebook gives a brief overview on quality management services Technical Monitoring (TMon) and Commissioning (Cx) to building owners, developers and tenants. Avoiding technical details, it shows the tremendous economic potential, gives insights on the most important technical aspects and provides hands-on advice for application in projects.

**Order the GB27: HVAC Commissioning Process and get the GB29: Quality Management for Buildings for free!**



# European Common Voluntary Certification Scheme and energy ratings



**JANA BENDŽALOVÁ**

ENBEE s.r.o., Bratislava, Slovakia  
e-mail: bendzalova@enbee.eu

The ALDREN European Common Voluntary certificate (EVC) for non-residential buildings aims to trigger the renovation rate by providing a reliable tool for high quality buildings recognition by the market, professionals and policy makers. This article describes the ALDREN approach related to the energy performance assessment and rating especially for high performing buildings and Deep Renovation identified as a priority under the European Green Deal.

The ALDREN energy performance rating and the associated reporting certificate, aims to provide a reliable, consistent and transparent instrument for benchmarking, prediction and assessment of high performing buildings and improvement achieved by energy renovation.

**Keywords:** European Common Certificate, European standards, energy performance of building, energy rating, scale, energy performance indicators, deep renovation, NZEB

The Renovation Wave initiative announced in the European Green Deal and the Commission recovery package are discussed today at the highest political levels. The announced financial support aims to increase the renovation rate of existing buildings and their transformation into highly efficient buildings.

A reliable, advanced tool and common metrics are needed which are able to benchmark such buildings, predict and prove that their required and actual performance have been achieved.

A comparable ambition level for renovation targets across the EU is crucial to achieve the EU climate targets.

The ALDREN European Common Voluntary Certificate (EVC) is a part of the ALDREN common framework that aims to provide a harmonised instrument for benchmarking, prediction and assessment of high energy efficient buildings and improvements achieved by renovation to avoid a suboptimal renovation with the potential long-term lock-in effect.

The energy performance certificates (EPCs) represent a crucial instrument for public policies and their role has been strengthened in the amendment of the EPBD [1]. The Member States are asked to improve the quality of energy performance certificates and to potentially verify the eligibility of the financial support by comparing energy performance certificates issued before and after renovation.

This project has received funding from the European Union's Horizon 2020 research and innovation programme under grant agreement 754159. The sole responsibility for the content of this paper lies with the authors. It does not necessarily reflect the opinion of the European Commission (EC). The EC is not responsible for any use that may be made of the information it contains.



Today there is a clear lack of comparability and no common quality benchmark as the calculations, indicators and the ambition levels of the national mandatory certificates differ per country or even per region [11]. ALDREN tries to close this gap.

The ALDREN proposal follows the previous developments for the EVC scheme presented to stakeholders in the frame of the study “Enabling the European Common Voluntary Certification scheme for non-residential buildings” [9] and the recommendations in market study for uptake of the EVCS [10].

## The ALDREN European Common Voluntary Certificate rating & targets

The ALDREN energy rating and targets aim to provide in the ALDREN European common certificate (ALDREN EVC) a transparent and comparable metric and more accurate results closer to the actual energy consumption. The ALDREN EVC is compatible with the EPBD requirements on the energy performance certificate. The reliability of the ALDREN approach is based on the following key components:

1. Harmonized and transparent calculation methodology based on the new European standards developed under the Commission Mandate M/480, that provides the results closer to the actual consumption using the hourly calculation step, the climate conditions of building location, the real performance of systems and envelope. The national standard use and occupancy schedule, assumed as conditions for calculation, represent the average building exploitation during a longer period (e.g. 15-20 years) considered for global cost and discounted cash flow (DCF) calculation for renovation options;
2. **Two main common indicators** for the benchmark on the **common scale** based on the non-renewable primary energy use either (a) with only the self-used PV electricity produced on-site taken into account or (b) including also the export to the grid (the main energy performance indicator);
3. The additional numerical indicators including a **“hurdle race”** towards the Nearly Zero Energy Building (NZEB) for the **“green”** ALDREN certificate because to achieve an energy class “A” is not sufficient for ALDREN NZEB level. The indicators were aligned with the existing schemes

(BREEAM, DGNB, HQE, IVE-BES) and with the recommendations in Level(s) [7];

4. Link of reported energy performance with **the thermal comfort score** based on the operative temperature obtained from the hourly energy simulation;
5. Possibility for calibration of calculation model using the measured energy (actual and calculated heating power based on EN 15378-3[6]);
6. A **common content** and **template** of European certificate reporting all indicators together with the **recommendations for improvement** of energy performance towards the NZEB with the link to more detailed ALDREN **Building Renovation Passport** (BRP).

The common calculation methodology ensures the harmonisation at the EU level and the level playing field for products and innovative solutions. It will also enable a common EU market for software and training of experts that started already within the CEN-CE project [13]. High level professionals, able to work with new CEN standards, are needed to run the ALDREN scheme.

Big differences in national energy performance certificates do not allow comparability because of different consideration of innovative solutions such as the production of renewable energy, for example. The monthly calculation step is used in most of countries while the hourly calculation is crucial for some systems assessment (heat pumps, cooling, PV electricity self-consumption and export) and for evaluation of indoor thermal environment.

The amended EPBD [1] requires Member States to describe their national calculation methodologies following the national annexes of the overarching standards. The “Annex A” of the overarching standard EN ISO 52000-1 [3] has been developed for the ALDREN EVC. This will ensure the consideration of technical systems, especially producing the renewable energy, in a transparent and harmonised way and facilitate the easier implementation of the ALDREN approach into national or EU certification schemes.

ALDREN introduces a harmonized European energy performance scale, with classes from A to G. Energy performance is reported in relative values to a reference point. The national energy performance scales are mostly based on EN ISO 52003-1:2017 [4] with two reference points. The ALDREN scale is a non-linear

scale based on one reference point [4] located on the upper limit of energy class “D” (Figure 1). The reference value is based approximately on the cost optimal level of minimum requirements calculated by the Member States in 2013 that are based on a comparable approach required by the EPBD [1]. Energy Class “A”, representing 35% of reference value, is required for ALDREN NZEB.

The reference values are based on calculation of several typical buildings and are set for offices and hotels for

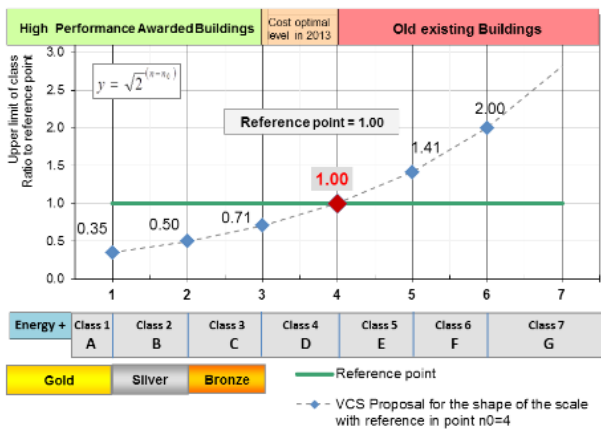

Ref = energy class D

| Class | Energy classes           |
|-------|--------------------------|
| A+    | EP < 0                   |
| A     | 0 < EP ≤ 0.35 Ref        |
| B     | 0.35 Ref < EP ≤ 0.50 Ref |
| C     | 0.50 Ref < EP ≤ 0.71 Ref |
| D     | 0.71 Ref < EP ≤ 1.00 Ref |
| E     | 1.00 Ref < EP ≤ 1.41 Ref |
| F     | 1.41 Ref < EP ≤ 2.00 Ref |
| G     | 2.00 Ref < EP            |

Figure 1. The ALDREN EVC scale with one reference point.

three climates (Warm, Moderate, Cold) (Figure 2).

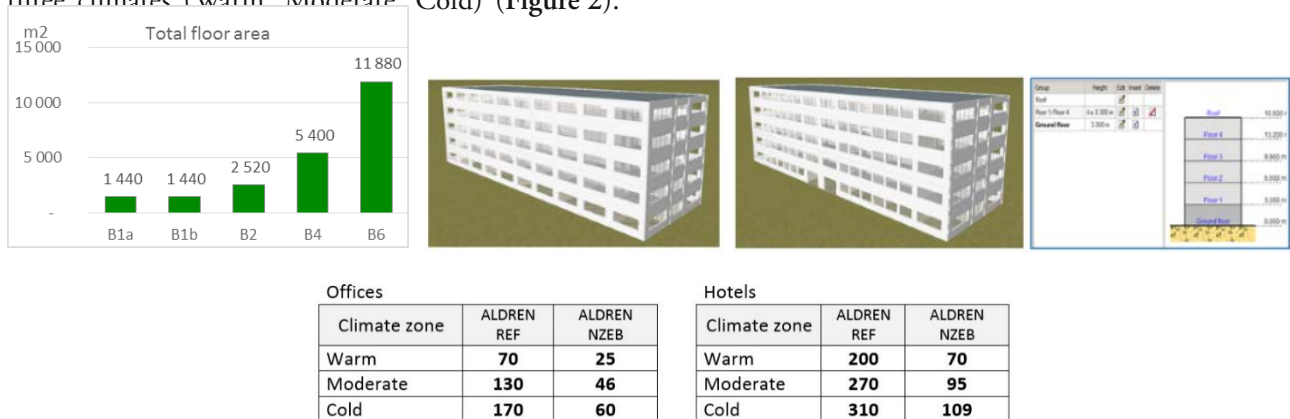

Figure 2. The Reference Values (REF) for ALDREN scale expressed in kWh/(m².a) of non-renewable primary energy and an example of a typical building for setting the scale.

The Commission Recommendation (EU) 2016/1318 on guidelines for the promotion of nearly zero-energy buildings [2] has been taken as the main reference for ALDREN NZEB definition.

The hotels are buildings with many different potential use scenarios depending on the operation (annual, seasonal), category, climate and the geographical area (urban, rural, coastal, mountain) and activities (business, Spa, B&B). The categorisation of hotels and the recommendations from the neZEH initiative [8] have been taken into account but the scale has to be still adapted based on the experience from pilot hotel buildings.

The thermal comfort score is reported in the ALDREN EVC together with the energy performance. The estimation of the score for each season (summer, winter, fall/spring) and the overall score is based on the hours during occupancy when the operative temperature is outside the assumed intervals for IEQ categories I – IV defined in EN 16798-1 [5]. The operative temperature is obtained by the hourly simulation of the building energy performance for standard use and behaviour of technical systems and for the Typical Meteorological Year (TMY). It reflects the indoor environment assumed for energy calculation only and not the real comfort in the specific rooms. Reporting this indicator together with the energy performance is important for comparison of solutions as the better energy performance due to a missing system (e.g. no cooling) is penalised by worse thermal comfort score. The link with the building resilience to climate change is also investigated. The example of the thermal comfort score reported in the ALDREN EVC and the hourly indoor operative temperature from simulation for TMY is shown in Figure 3.

### The ambition level of ALDREN energy targets

The current financial instruments often refer to the best practices (achieved levels) in the existing commercial environmental schemes (e.g. BREEAM, LEED, DGNB, Passive house) because the requirements of these schemes go beyond the legal minimum requirements. This is also the ambition of ALDREN EVC energy performance rating.

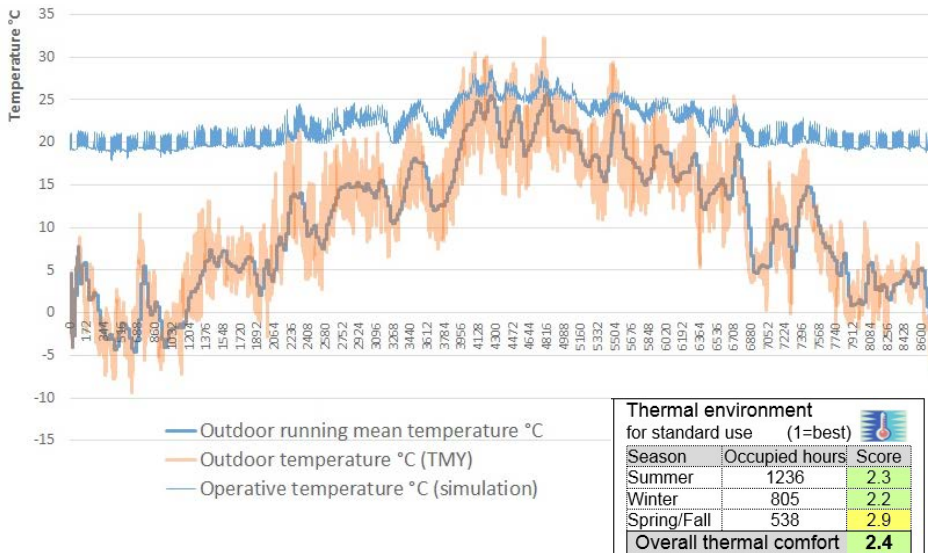
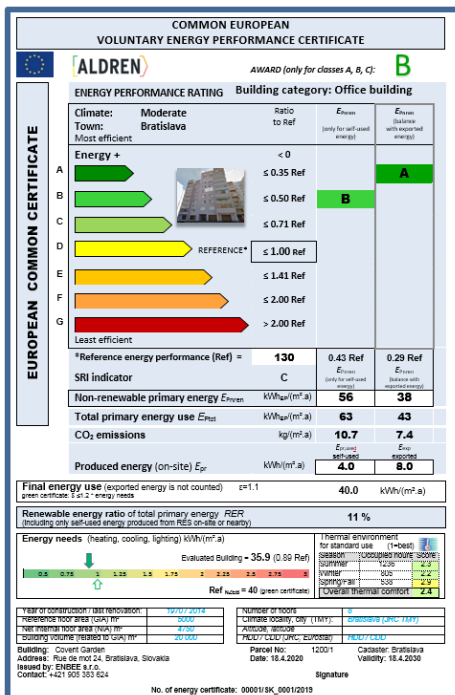

Figure 3. Example of the thermal comfort score reported in the ALDREN EVC for hourly indoor operative temperature obtained from simulation.

The main target of ALDREN renovation strategies is the ALDREN NZEB level. It is not sufficient to achieve the energy class “A” but the “hurdle race” is required to be fulfilled in line with the recommendations in EN ISO 52000-1 [3]. The criteria for ALDREN NZEB for which the threshold values have still to be tested on pilot buildings are:

- Energy class “A” for the non-renewable primary energy use;
- A maximum level of energy needs (heating, cooling, lighting);
- A maximum expenditure factor for final energy;
- the overall thermal environment score below required level.

To provide a direct support for green investment the high performing buildings that achieved ALDREN NZEB level are highlighted by a “Green ALDREN Certificate” as shown in Figure 4.



a)

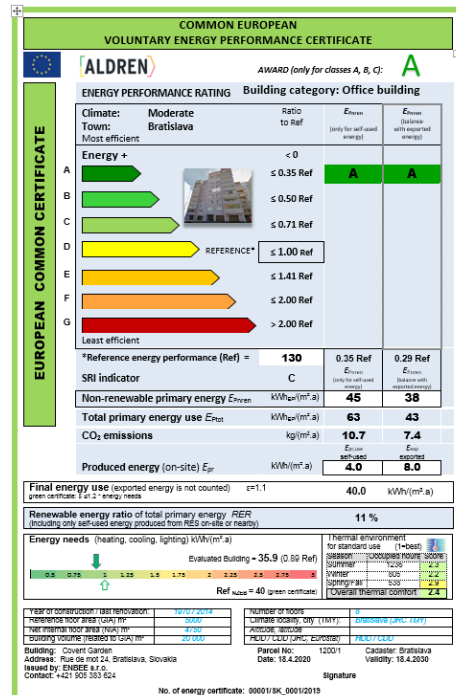

b)

Figure 4. The template of the cover page of “standard” (a) and “green” (b) ALDREN certificate.

The energy classes achieved by one of ALDREN’s pilot office buildings in Slovakia on the ALDREN scale and on the national scale for the mandatory energy performance certificate (EPC) are presented in Figure 5.

The comparison shows not only a much higher ambition level of ALDREN benchmark but also the ability of ALDREN scale to show the intermediate improvements by shifting from one class on the scale to the better energy class.

### The position of ALDREN EVC

The ALDREN EVC is not to be considered as a competing instrument with the national mandatory EPCs. The two are complementary; both have an important role to play in the climate policy framework.

The national mandatory EPCs provide comparison of building energy performance against the national building stock and the cost optimality has to be taken into account. The price for issuing the mandatory energy performance certificate is also an important issue.

The position of the ALDREN EVC is different as it aims to trigger investment in deep renovation in non-residential buildings. Indeed, a higher ambition level is required for financial support and a more accurate prediction of energy performance is needed for building owner for his decision-making process towards the deep renovation. The ALDREN EVC may illustrate a potential pathway for national EPCs evolution towards reinforced performance request.

The ALDREN Common European voluntary certificate:

- Can stand alone or can be taken over at the EU, national or commercial level (e.g. by banks) for some purposes (e.g. for financial instruments);
- Can be integrated in other existing voluntary commercial certification schemes as an energy module (e.g. BREEAM, DGNB, IVE, HQE);
- Can complement the national EPCs for some cases (e.g. for subsidies).

Article 11 (9) of the EPBD requires that the Commission in consultation with relevant sectors, adopts a voluntary common European Union certification scheme for the energy performance of non-residential buildings. The ALDREN EVC could support Article 11(9) as a technical tool.

### Implementation in pilot buildings - link with other ALDREN tasks

In the testing phase, the ALDREN protocol has been applied on several pilot buildings. The ALDREN EVC is only one piece in the ALDREN holistic approach. EVC also provides inputs to other ALDREN tasks and it is part of ALDREN’s EVC+ that reports also the additional pages to describe the actual (measured) energy performance, IEQ and the financial impacts of proposed energy renovation actions. Energy cost savings, the non-energy benefits from improved indoor environment (renting rate, vacancy) are inputs in discounted cash-flow and balance with the investment for potential renovation options discussed with building managers.

| The Stage                            | Original (as constructed) | Current (partly renovated) | Deep renovation 1 | Deep renovation 2 (DH) |
|--------------------------------------|---------------------------|----------------------------|-------------------|------------------------|
| Non-renewable PE (no PV)             | 174.3                     | 164.6                      | 59.2              | 71.4                   |
| Non-renewable PE (self-used PV only) | 174.3                     | 164.6                      | 47.8              | 59.6                   |
| Non-renewable PE (- PV export)       | 174.3                     | 164.6                      | 43.8              | 56.1                   |
| Savings                              | -                         | 5.6%                       | 73.4%             | 65.9%                  |

| The Stage                                     | Original (as constructed) | Current (partly renovated) | Deep renovation 1 | Deep renovation 2 (DH) |
|---|---------------------------|----------------------------|-------------------|------------------------|
| ALDREN energy class (no PV)                   | E                         | E                          | B                 | C                      |
| ALDREN energy class (self-used PV only)       | E                         | E                          | B                 | B                      |
| ALDREN energy class (- PV export)             | E                         | E                          | A                 | B                      |
| ALDREN NZEB (A):                              |                           |                            | 46                |                        |
| Official EPC class (2020) (no PV):            | B                         | B                          | A0                | A1                     |
| Official EPC class (2020) (self-used PV only) | B                         | B                          | A0                | A0                     |
| Official EPC class (2020) (-PV export):       | B                         | B                          | A0                | A0                     |
| Official EPC NZEB (A0):                       |                           |                            | 61                |                        |

Figure 5. The comparison of energy classes achieved by the pilot building on the ALDREN EVC scale and on the scale for national mandatory EPC.

IAD Investments volunteered to implement the ALDREN protocols on their head office building Maly trh 2/A in Bratislava. One of their financial products “Prvý realitný fond” is the first and oldest real estate fund in Slovakia (28 years on the market) that invests in various types of real estate such as office and commercial buildings, logistic parks, hotels & wellness in several Central European countries. Its return is generated by lease and market valuation of real estate. The ALDREN EVC allows comparability and reliability around the EU and could help with the recognition of high-quality buildings or risk in the stage of new building acquisition.

An example of renovation actions and individual steps implemented and planned (ALDREN RenoMap) for IAD pilot building and the link with other ALDREN tasks is presented in **Figure 6**.

It shows the connection of energy ratings with the thermal comfort and financial valuation (DCF) based on the energy and non-energy benefits.

A significant improvement has been already achieved for IAD building by the additional thermal insulation of the

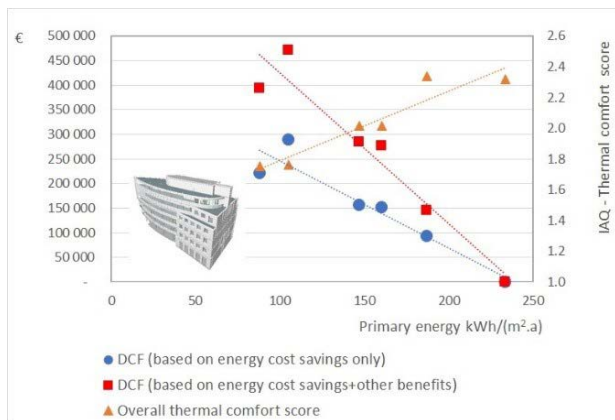
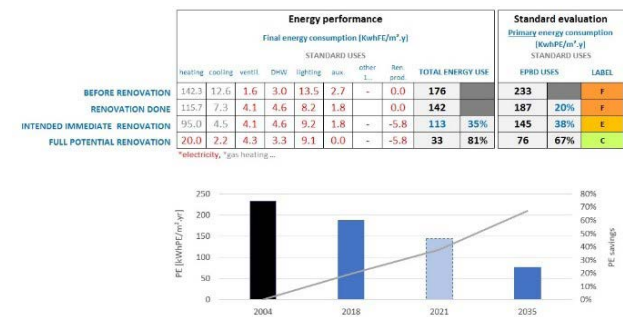

**Figure 6.** Example of connection of energy ratings with the RenoMap, thermal environment and financial valuation (pilot building Maly trh 2/A, Bratislava).

light weight façade. Future potential energy savings were identified together with the building manager (the facade joints sealing, technical possibility to change to triple glazing, the potential for PV installation) (**Figure 7**).

An important part of energy performance assessment remains in the link with the actual consumptions.

The example in **Figure 8** shows how close can be the results from hourly simulation for the ALDREN EVC rating to actual measured energy.



**Figure 7.** Pilot building Maly trh 2/A, Bratislava.

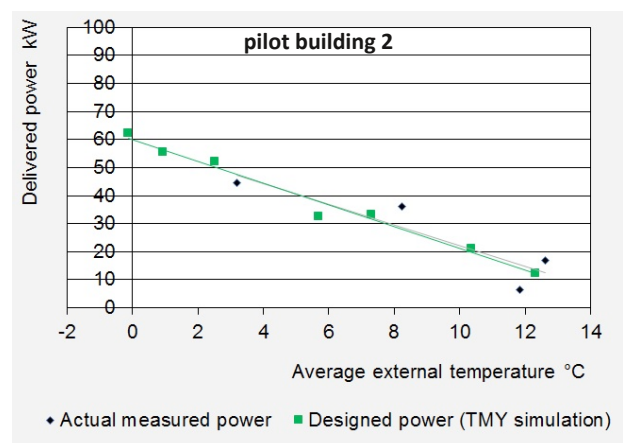
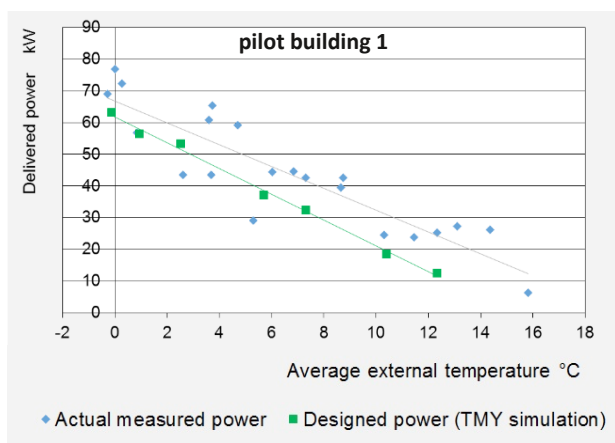

**Figure 8.** Comparison of energy signature from simulation (TMY) and from the actual monthly energy consumption (gas) for two different pilot buildings.



The energy signature developed for heating according to EN 15378-3 [6] from measured gas consumption was used to calibrate the calculation model for ALDREN EVC. The energy signature based on the simulation can be used by building manager in the future for checking the actual building operation.

The significant difference between both, the calculated delivered power for the climate conditions of the Typical Meteorological Year (TMY) and the actual power under the actual climate conditions, can inform about the malfunctions in building operation or can help to improve the calculation model.

## Conclusion

The goal of ALDREN project is to align the market recognition for high quality energy retrofit with the enhanced building value based on the evidence and awareness rising of key stakeholders involved in the deep renovation process.

The ALDREN EVC aims to support the EU climate related policy by providing the harmonised common metrics based on the European standards. ■

## References

- [1] Directive 2010/31/EU of the European Parliament and of the Council of 19 May 2010 on the energy performance of buildings, amended by Directive (EU) 2018/844 of the European Parliament and of the Council of 30 May 2018 amending Directive 2010/31/EU on the energy performance of buildings and Directive 2012/27/EU on energy efficiency.
- [2] Commission Recommendation (EU) 2016/1318 of 29 July 2016 on guidelines for the promotion of nearly zero-energy buildings and best practices to ensure that, by 2020, all new buildings are nearly zero-energy buildings.
- [3] EN ISO 52000-1:2017 Energy performance of buildings — Overarching EPB assessment — Part 1: General framework and procedures.
- [4] EN ISO 52003-1:2017 Energy performance of buildings — Indicators, requirements, ratings and certificates - Part 1: General aspects and application to the overall energy performance.
- [5] EN 16798-1:2018 Energy performance of buildings – Ventilation of buildings – Part 1: Indoor environmental input parameters for design and assessment of energy performance of buildings addressing indoor air quality, thermal environment, lighting and acoustics.
- [6] EN 15378-3:2017 - Energy performance of buildings - Heating and DHW systems in buildings - Part 3: Measured energy performance.
- [7] JRC Science for policy report, Level(s) – A common EU framework of core sustainability indicators for office and residential buildings: Part 3, (Draft Beta v1.0), August 2017.
- [8] neZEH initiative (Nearly Zero Energy hotels) <http://www.nezeh.eu/home/index.html>.
- [9] Bendzalova J., "Specific criteria related to the label (display) and the content of energy performance certificate", Workshop – public consultation, "Enabling the European Common Voluntary Certification Scheme for non-residential buildings", ENER/C3/2015-545, 2016.
- [10] Market study for a voluntary common European Union certification scheme for the energy performance of non-residential buildings, Final Report, Triple E Consulting, 2014 for DG Energy ENER/C3/2012-436.
- [11] Zirngibl J., Bendzalova J. – "Technical assessment of national/regional calculation methodologies for the energy performance of buildings", Final report, 2015, ENER/C3/2013-425.
- [12] ALDREN, Horizon 2020 project, (Alliance for Deep RENovation in buildings) <https://aldren.eu/>.
- [13] CEN-CE, Horizon 2020 project, (CEN EPB standards certified experts), [www.cen-ce.eu](http://www.cen-ce.eu).

# Closing the energy gap in renovations of offices and hotels



**ROBERT COHEN**

Verco Advisory Services, UK  
robert.cohen@vercoglobal.com



**GREG WARING**

Verco Advisory Services, UK  
greg.waring@vercoglobal.com



**SAADIA ANSARI**

Verco Advisory Services, UK  
saadia.ansari@vercoglobal.com

ALDREN [1], an EC-funded Horizon 2020 project, aims to establish the business case for deep renovation and accelerate the movement towards a nearly zero energy non-residential building stock by 2050. This paper describes a process developed to close the gap between calculated and measured energy performance in renovated offices and hotels.

**Keywords:** verified energy performance; deep renovation; retrofit; offices; hotels

## Background

Two thirds of existing buildings in the EU are expected to be still in use in 2050, 30 years from today [2]. Many commentators assess that the EU's contribution towards the goals of the Paris Agreement can only be achieved if the energy demand from most of these buildings is drastically reduced by deep retrofits. Recital 16 of the Energy Efficiency Directive [33] defines 'deep renovations' in a broad way, as "*renovations which lead to a refurbishment that reduces both the delivered and the final energy consumption of a building by a significant percentage compared with the pre-renovation levels leading to a very high [efficient] energy performance*". One esti-

mate is that only 1% of current renovations achieve this [4]. The Renovate Europe campaign proposes an energy demand reduction target of 80% by 2050 from 2005 levels [5]

The aim of ALDREN is to establish the business case for deep renovation in non-residential buildings with a focus on offices and hotels. The 3-year programme which started in November 2017 intends to encourage investment and accelerate the movement towards a nearly zero energy non-residential building stock across the EU, by 2050 to meet Paris Agreement commitments.

This project has received funding from the European Union's Horizon 2020 research and innovation programme under grant agreement 754159. The sole responsibility for the content of this paper lies with the authors. It does not necessarily reflect the opinion of the European Commission (EC). The EC is not responsible for any use that may be made of the information it contains.



A key attribute of the approach to be adopted by ALDREN is the idea of energy performance verification. This means that the energy performance predicted at the design stage of a deep renovation will be verified by measurements during the first year of full occupancy. The thesis of ALDREN continues that if we are going to start measuring the actual energy efficiency of buildings, then investors, developers and owners will want confidence that their renovated buildings will perform well. ALDREN is therefore a process which aims to underwrite the operational performance of building retrofits. It learns from Australia's success in improving the energy efficiency of commercial office buildings through Commitment Agreements [6] and previous EC-funded research on hotels [7].

This paper describes a methodology which supports both the achievement and verification of target energy performance outcomes. The energy scope is whole building HVAC, hot water and lighting which corresponds to the requirements of the amended EPBD Annex 1 [8].

### Performance Verification protocol

The process proposed for ensuring the target energy performance of a deep retrofit is achieved and verified using measured data is illustrated in Figure 1 and has these key steps:

1. Calculate energy performance for existing building under standard conditions
2. Calculate energy performance for existing building under actual conditions
3. Measure existing building energy use, compare with predicted energy use and calibrate model to match measurements
4. Use calibrated model to agree list of building improvements for fabric, plant, controls, etc.
5. Calculate energy performance under actual conditions
6. During first year of operation, compare measured vs calculated energy under actual conditions at monthly and sub-meter resolution
7. Calculate “verified” energy performance under standard conditions for upgraded building

Within steps 3 and 6, it is essential that comparisons of modelled and measured energy use are made on a like-for-like basis:

1. Each is subject to the same boundary conditions. Typically, this means ensuring that actual occupant numbers and hours of use, energy-using equipment density ( $W/m^2$ ) and weather over the year of measurement are applied (as far as possible [9]) in a re-run of the model.
2. Care is taken to compare results for the same energy uses. This requires a good understanding of what

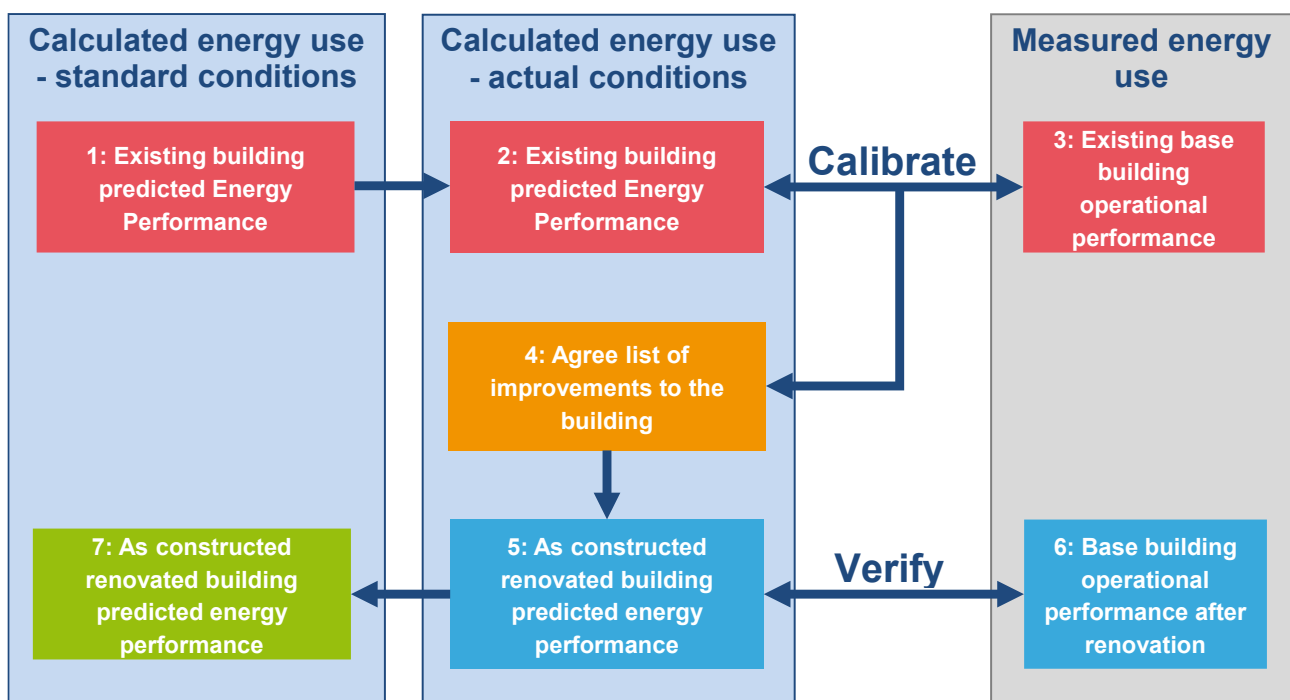

Figure 1. Planned energy performance verification process for deep retrofits.

is being measured by each sub-meter and mapping this to energy metering points in the model.

The ambition for verification of energy performance suggests an expectation that metered values will be close to the simulated targets, but there are three challenges:

1. **Inadequacies of models.** Commonly used models required for regulatory compliance and EPCs are unlikely to predict energy use by sub-meter accurately.
2. **Inefficient building operation.** Many (if not most) air-conditioned office buildings suffer from multiple imperfections in the way they are operated and controlled. Control systems are not designed and specified in sufficient detail, do not enable HVAC and lighting service levels to be tailored to demand, and rarely set out to limit services to unoccupied parts of a building (voids and when out of hours use varies across tenancies). Building managers and their facilities management teams often lack the skills needed to operate a building efficiently and are not incentivised to improve performance.
3. **Indoor environmental quality.** Control settings in a real building may not match the specifications assumed in the model.

The ALDREN energy performance verification protocol proposes three ingredients to overcome these challenges:

### **A. Dynamic thermal simulation of building design and HVAC system**

During the design stages, simulation of the building and its HVAC system and controls, with a time step of one hour or less, should be undertaken to predict heating and cooling demands. The level of simulation proposed for ALDREN differs from current practices but is not ground-breaking, in the sense that it has become routine practice in Australia [10], and is used to some extent in the US under the guidance of ASHRAE 90.1 [11]. ASHRAE also offers an accreditation scheme for “Building Energy Modelling Professionals”: the BEMP Certification [12].

There are several key objectives of more advanced simulation:

- To understand how the HVAC system would operate for each hour of the year and thereby confirm plant

capacity requirements more robustly and enable designers to identify how much time would be spent in more or less efficient operating modes

- To confirm that the proposed design is capable of meeting the target energy performance
- To use ‘off-axis scenarios’ to check the resilience of the energy performance to plausible future scenarios for hours of use, intensity of use (people and equipment) and weather
- To inform the development of a Verification Plan which identifies necessary sub-metering and produces monthly targets for each sub-meter and each sub-system (heating, hot water, cooling, fans, etc.).
- To inform the optimisation of HVAC control.

### **B. Independent design review**

An independent design review (IDR) should be undertaken by an independent and experienced energy efficiency professional who has been assessed for high levels of expertise in relation to:

- deep retrofit building projects and the design of HVAC services and their controls
- commissioning/tuning of buildings
- energy auditing and energy efficiency improvement of existing buildings
- simulation of building performance.

The IDR scrutinises the design, Control Plan, Validation Plan, a functional description of the controls and the simulation outputs with the overarching objectives of checking the risk the building will not achieve its target performance and recommending improvements. The final design should consolidate into the design package any changes arising from the IDR.

### **C. Continual alignment of actual building with the simulation model**

At the start of the design stage, a Control Plan should be agreed which specifies which parties will be able to control the HVAC (landlord, tenants, hotel guests, etc.). By the end of the final design stage, a simple description of the controls which implements the control plan should be articulated in plain English in a Description of Operations (DesOps).

The DesOps should be made available to tenderers for the controls engineering and used as an input into the design and functional description of the HVAC

controls. Any refinements introduced to the control strategy should be reflected in a revised version of the DesOps that emerges on completion and handover.

During the tendering and construction stages, it is important to keep the simulation model and DesOps up to date with any significant design changes. For example, if any changes threaten the achievement of the target rating after a value engineering process, further modelling may be needed to demonstrate that the target would not be compromised.

A key objective of commissioning should be to ensure the control algorithms in the completed building are consistent with the functional description of the HVAC controls, the simulation model of the final design and the revised DesOps.

Once the building is in occupation, measured energy use data should be collected, following the Validation Plan, and monthly monitoring reports prepared comparing sub-metered performance to simulated predictions. The reports should highlight any risks that the energy performance will fail to meet the target, and identify potential remedial actions.

Performance based maintenance contracts for managing agents and facilities managers are likely to produce the best chance of achieving the target energy performance. Meters should be treated as maintainable assets and the tasks of meter data collection and processing should be requirements of the maintenance contract.

Four BMS tuning exercises should be undertaken during the defects liability period to check controls are working optimally during different seasons of the year [13].

A performance verification tool developed by the ALDREN project acts as a repository for data generated during the various protocol stages described above and presents a side-by-side comparison of predicted and measured energy consumption data in order to verify the renovated building's energy performance in operation is in line with design targets.

## Conclusions

ALDREN proposes an energy performance verification protocol for deep retrofits of offices and hotels. It is anticipated that using detailed simulation of HVAC systems and their controls, alongside the dynamic thermal simulation of the building itself, for prediction

and target setting, will enable performance outcomes to come close to matching design aspirations in air-conditioned buildings. ■

## References

- [1] ALDREN (Alliance for Deep RENovation in buildings) <https://aldren.eu/>.
- [2] European Parliament Energy efficiency of buildings A nearly zero energy future? May 2016.
- [3] European Union: Directive 2012/27/EU of the European Parliament and of the Council on Energy Efficiency, Recital 16 October 2012.
- [4] The Economist, Investing in energy efficiency in Europe's buildings. A view from the construction and real estate sectors, 2013.
- [5] The Renovate Europe campaign <https://www.renovate-europe.eu/>.
- [6] Bordass, WT, Cohen, RR and Bannister, P "Design for performance: UK Commitment Agreements: Making measured energy in-use the objective for new office buildings, Feasibility Study Final Report, published by the Better Buildings Partnership (BBP), May 2016.
- [7] Tsoutsos T, Tournaki S and Frangou M, Nearly Zero Energy Hotels in Europe (NEZEH), Technical University of Crete, 2016 [www.nezeh.eu](http://www.nezeh.eu).
- [8] Directive (EU) 2018/844 of the European Parliament and of the Council of 30 May 2018 amending Directive 2010/31/EU on the energy performance of buildings.
- [9] To determine precise hours and density of use over a year throughout a building could be time intensive.
- [10] New South Wales Office of Environment and Heritage, Handbook for estimating NABERS ratings Version 1.2, July 2019.
- [11] ASHRAE Standard 90.1, Energy Standard for Buildings Except Low-Rise Residential Buildings, 2016.
- [12] U.S. affiliate of the International Building Performance Simulation Association (IBPSA-USA) and the Illuminating Engineering Society (IES), BEMP – Building Energy Modelling Professional Certification.
- [13] The ALDREN performance verification protocol also offers an alternative approach promoted by another H2020 project, the QUANTUM 'performance test bench' tool [14]. The contractor defines how to test the control of each data point is happening correctly and once the building is in operation, an independent verifier checks and produces a robust defects list for the contractor to resolve.
- [14] Mechanical and Electrical Engineering Working Party of National, Regional and Local Authorities (AMEV) for QUANTUM project, Technical Monitoring as an Instrument for Quality Assurance, 2017.

# Application of ALDREN-TAIL index

## for rating the indoor environmental quality of buildings undergoing deep energy renovation



**WENJUAN WEI**

Scientific and Technical Centre  
for Building (CSTB), France



**CORINNE MANDIN**

Scientific and Technical Centre  
for Building (CSTB), France



**PAWEL WARGOCKI**

International Centre for Indoor  
Environment and Energy,  
DTU, Denmark

One of the limitations for advancing indoor environmental quality (IEQ) in buildings is the lack of a common metric or a set of agreed indicators for IEQ. Wei et al. (2020) showed that nearly 100 different parameters are used to monitor and express IEQ in different standards and certification schemes worldwide. Still, no standard, uniform, and agreed metric have been developed so far. Deep energy renovation (DER) of buildings intentionally or not intentionally affect IEQ. DER, as a consequence, may have adverse effects resulting in discomfort, increased risk for health, or reduced productivity, which needs to be detected and immediately mitigated. But DER can also provide benefits of improved comfort, health, and productivity that are not accounted for when the cost-benefit analyses of building renovations are made. A fair conclusion will be that IEQ is inadequately addressed during energy renovations because of the lack of this standard metric.

ALDREN project consequently developed an index that allows rating of IEQ in buildings that are in operation

and undergo DER as well as a method for predicting IEQ during the design of DER (Wargocki et al., 2019a, 2019b, 2020). The former is called ALDREN-TAIL, in short TAIL, the latter is called predicTAIL. In both cases, TAIL describes four components of IEQ, i.e., thermal environment (T), acoustic environment (A), indoor air quality (I), and luminous (visual) environment (L), as well as the overall quality of the environment.

### TAIL index

The TAIL index consists of 12 parameters describing IEQ (Table 1). The parameters are defined based on a review of the state-of-the-art of IEQ indicators proposed by Green Building (GB) schemes, European standards, research projects and scientific publications (Wei et al., 2020). They are also aligned with the requirements of standards supporting the European Energy Performance of Buildings Directive (EPBD). For each parameter, four ranges are defined describing their four quality levels aligned with the quality levels included in the standard

This project has received funding from the European Union's Horizon 2020 research and innovation programme under grant agreement 754159. The sole responsibility for the content of this paper lies with the authors. It does not necessarily reflect the opinion of the European Commission (EC). The EC is not responsible for any use that may be made of the information it contains.



EN16798-1. The four quality levels of the 12 parameters and the four IEQ components defining the ALDREN-TAIL index are depicted with one of the four colors: green representing high-quality level, yellow indicating medium quality level, orange showing moderate quality level, and red representing low-quality level. The Roman numbers indicate the overall IEQ level, i.e., I, II, III, and IV, corresponding respectively to green, yellow, orange, and red quality levels (Figure 1). The twelve parameters are determined before and after energy renovation using measurements in buildings, observations (only visible mold), or simulations (only daylight factor). The detailed protocol for measurements has been developed. The quality level of each component of TAIL and the overall IEQ level is determined by the lowest quality to create incentives for improvement and not to compromise any of the major components of IEQ.

### Application of TAIL in buildings before or after energy renovation

With the ALDREN project, the TAIL has been applied in six buildings before or after having been retrofitted to determine the quality of the indoor environment. Below there is an example of measurements from one office building performed in November 2019. According to the measuring protocol and given the size of the building, eight representative rooms were selected for measurements. In each room, the parameters defining TAIL (Table 1) were determined; measurements were performed for one week using on-line instrumentation and passive samplers. For temperature, the measurements were performed over one month. The daylight factor was modeled. There were no visible signs of mold.

Table 1. ALDREN-TAIL indicators.

| T<br>(thermal<br>envir.) | A<br>(acoustic<br>envir.) | I<br>(indoor air<br>quality) | L<br>(luminous<br>envir.) |
|--------------------------|---------------------------|------------------------------|---------------------------|
| Air temp.                | Sound pressure level      | CO <sub>2</sub>              | Daylight factor           |
|                          |                           | Ventilation rate             | Illuminance               |
|                          |                           | Air relative humidity        |                           |
|                          |                           | Visible mold                 |                           |
|                          |                           | Benzene                      |                           |
|                          |                           | Formaldehyde                 |                           |
|                          |                           | PM <sub>2.5</sub>            |                           |
|                          |                           | Radon                        |                           |

The measured values at each measuring point during working hours were compared with their defined ranges (Wargocki et al., 2020), and their quality levels were determined. The quality level of each parameter defining TAIL was obtained by calculating the interim rating at each of the eight measuring locations:

$$\text{Interim rating} = \frac{\sum_1^k R_k * O_k}{n} \tag{1}$$

where *R* is the rank for the specific quality level *k* (*R* = 1 for green level, *R* = 2 for yellow level, *R* = 3 for orange level and *R* = 4 for red level); *O* is the number of observed rooms for the specific quality level *k*; *k* is the number of quality levels (*k* ≤ 4); *n* is the total number of the rooms where measurements are performed.

The final quality level of each of the four TAIL components at the building level was determined by the worst interim rating for the thermal environment (T), acoustic environment (A), indoor air quality (I), and the luminous environment (L). The overall rating of IEQ was determined by the worst level of the four TAIL components.

Figure 1 shows the TAIL level of the building. The thermal environment in the building (T) was qualified at the yellow level because the indoor air temperature varied between 20 and 24°C during more than 94% of the working hours in 5 rooms. The thermal environmental quality could be improved to the green level if the indoor temperature had been reduced to 23°C during midday. The acoustic environment in the building (A) was qualified at the green level because the sound pressure was lower than 35 dB(A). The indoor air quality in the building (I) was qualified at the orange level mainly because CO<sub>2</sub> concentrations in the measured rooms often exceeded 1200 ppm, and there were high concentrations of formaldehyde. The indoor air quality could be improved by increasing the air change



Figure 1. TAIL level of an office building.

rate in highly occupied spaces. The luminous environment in the building (L) was qualified at the orange level because the median daylight factors in the selected rooms were between 1.7% and 3%, and the illuminance levels in the measured rooms were often higher than 500 lux at the desk height. The visual environment could be improved by renovating sun protection systems and reducing artificial lighting.

Since the lowest quality level among TAIL components was orange, the overall quality level of IEQ and the overall rated TAIL level was also orange, which is represented by the Roman III in the middle of the TAIL indicator for this building (Figure 1).

### Predicting TAIL index: PredicTAIL

Because the TAIL index should guarantee a good IEQ after the energy renovation, it must also be possible for the building owners or investors to assess what could be the influence of the different renovation actions on IEQ. For this purpose, the predicTAIL index was created. PredicTAIL includes the same IEQ parameters, the same quality levels and the same calculation method as TAIL, but is purely based on modeling. PredicTAIL is modeled before renovation to serve as the baseline, and then it is modeled for different renovation strategies. By comparing PredicTAIL after with PredicTAIL before energy renovation, the best renovation strategy can be chosen. PredicTAIL is an additional tool for decision making and is not a verification tool for TAIL. Both should be used independently.

### Conclusions

TAIL creates an incentive to improve IEQ as well as the framework that allows qualitative and quantitative assessment of non-energy benefits resulting during the process of a deep energy retrofit. The TAIL index focuses on office and hotel buildings to be aligned with the ALDREN procedure, but the intention is to use it in any type of building.

Being measured before the renovation, the TAIL index helps to identify the possible components to be improved on the occasion of the energy renovation, making the latter even more beneficial for the building and its occupants. In case of measurements done after the energy renovation, the TAIL index 'after' compared to the TAIL index 'before' helps in showing that the renovation has not degraded the IEQ in the building or whether the IEQ improved. ■



### Interview with Prof. Francis Allard

Professor Emeritus,  
La Rochelle University, France

#### 1. Is there a need for an IEQ indicator, and why?

– The ALDREN initiative is certainly very promising. To have a comprehensive indicator of indoor environment quality corresponds to a real preoccupation of all professionals in the search of complete evaluation of a building quality. The complete evaluation of health and overall comfort conditions indoors is necessary to assess the quality of use of a building, the definition of a first aggregate indicator even if it is not integrating every single aspect of IEQ is a real progress in this way.

#### 2. Does TAIL fulfil this need, and why (benefits of TAIL)?

– In my opinion TAIL answers this need. In order to be efficient and used by professionals, the IEQ indicators need to be as complete as possible, built on solid scientific basis and easy to understand. We already have many environmental quality indicators used by environmental quality assessment methods everywhere in the world but all of them are based on a long list of individual indicators which makes difficult to have a clear vision of the overall quality. For me, the TAIL method fulfills this need.

#### 3. Do you think TAIL would be accepted by building professionals?

– It is always very difficult to predict the acceptability of a method or a concept. However, TAIL is quite attractive by its apparent simplicity. It is complete, easy to understand, and efficient in the overall approach to the assessment of indoor environment quality. I really think it will be accepted easily by our professionals.

#### 4. What should be next step in developing TAIL?

– TAIL needs to be tested in different types of building types (offices, residential, schools, etc.) in a wide range of climates. The testing protocols have to be evaluated carefully to strengthen the method and the limits of such a complete IEQ indicator have to be clearly stated. Then, this indicator could be used easily in the evaluation of rehabilitation projects. Most of the projects are focusing mainly on the energy performance and it will be a real benefit to add this IEQ indicator.





### Interview with Dr. Stylianos Kephelopoulos

European Commission, Directorate  
General Joint Research Centre

#### 1. Is there a need for an IEQ indicator, and why?

– IEQ indicators and other health-based criteria and requirements are given emphasis in a number of building related policy and legislative instruments (e.g. amended EPBD, Construction Products Regulation, European standards and national regulations, etc.). However, a major obstacle for integrating energy and IEQ strategies in the design and optimisation of buildings is the lack of a common, quantitative metrics for IEQ although the worldwide definitions of IEQ generally agree about the main components contributing to the IEQ of buildings and IEQ is considered in existing GBC schemes. Therefore, there is need for a commonly defined and accepted IEQ indicator in EU and worldwide.

#### 2. Does TAIL fulfil this need, and why (benefits of TAIL)?

– TAIL is among the IEQ indicators, indices and tools, which were recently reviewed by EC Services (DG ENER & DG JRC) regarding their potential to be used in the process of IEQ data integration into the EU Building Stock Observatory. TAIL was developed as result of an extensive review process, which can be regarded as a reference for selecting parameters and for development of IEQ indicators that are commonly used in energy performing buildings. Moreover, it is compliant with major certification schemes, EN16798-1 and Level(s). Therefore, the TAIL method can be directly used in the process of defining and applying a common IEQ metric addressing the EU building stock.

#### 3. Do you think TAIL would be accepted by building professionals?

– TAIL has the potential to attract the interest of investors in IEQ and of building professionals, as it can be determined with small extensions to the measuring protocol when performing building certification using major Green Building and Sustainability Certification Schemes. TAIL ranks among the top IEQ concepts and methodologies which were reviewed by EC which present high degree of comprehensive use and affordability to

end users, however, needs to undergone validation before it can be effectively applied beyond the purpose for which was developed and after having assessed the feasibility and flexibility of its application at various scales (local, national, EU), buildings' typologies and assessment objectives.

#### 4. What should be next step in developing TAIL?

– Further development of TAIL should be driven by the need of defining and applying a harmonised IEQ indicator at EU level at affordable cost, to assess IEQ in energy performing buildings via a well-balanced and complementary approach of objective (i.e. via measurements) and subjective (i.e. perceived IEQ) assessment which considers the following aspects: variation of IEQ parameters over time (e.g. variation of a calendar year, or different seasons); flexibility for application across different typologies of buildings and different objectives of assessment; need for adjusting IEQ parameters and their weighting according to different national contexts and specificities in EU MS.

### References

Wargocki, P.; Mandin, C.; Wei, W.; Espigares, C.; Bendzalova, J.; Greslou, O.; Rivallain, M.; Zirngibl, J.; Assessment of indoor environmental quality (IEQ) in offices and hotels undergoing deep energy renovation – the ALDREN method. *REHVA Journal*, 2019a, 51-53.

Wargocki, P.; Mandin, C.; Wei, W.; ALDREN-TAIL index for rating IEQ. *ASHRAE Journal*, 2019b, 66-68.

Wargocki, P.; Wei, W.; Anton, R.; Bendžalová, J.; Espigares-Correa, C.; Gerard, C.; Greslou, O.; Rivallain, M.; Sesana, M.; Zirngibl, J.; Mandin, C.; ALDREN-TAIL: a new index for assessing indoor environmental quality in offices and hotels undergoing deep energy renovation. To be submitted.

Wei, W.; Wargocki, P.; Zirngibl, J.; Bendzalova, J.; Mandin, C.; Review of parameters used to assess the quality of the indoor environment in Green Building certification schemes for offices and hotels. *Energy & Buildings*, 2020, 209, 109683.

# Linking ALDREN's energy and IEQ performance assessments to financial value of buildings



**OLIVIER GRESLOU**  
CSTB, France



**JANA BENDŽALOVÁ**  
ENBEE, Slovakia

Current levels of investment are insufficient to meet the European Union's energy renovation objectives. There is a growing awareness that energy, health and comfort performance is relevant for the financial value and attractiveness of building assets, but sustainability information remains underexploited in multi-year provision plans, financial valuation and risks appraisal. ALDREN participates in bridging the gap between energy experts and engineers on one side and real estate financial experts and banks on the other side.

## Sustainability and financing: a quickly evolving context

Climate and responsible finance are booming with the development of new green financial products. Banks and insurance companies start questioning additional financial risks associated with the extra financial performance of their assets related to environmental performance, quality and resilience to climate change. Growing concerns for environmental issues and reinforced political targets will impact real estate strategies in the coming years. Sustainability topics are expected to become more and more reflected in the rental and market value of building assets.

However, sustainability-related information is still overlooked in common valuation approaches. Financing the required up front investments for deep energy and climate related renovation remains a challenge. Most financing approaches consider traditionally that energy savings result in not very favourable return

of investments (ROIs) in some countries and exclude all the potential co-benefits of energy renovation on asset value and risk reduction in the mid to long term.

ALDREN has therefore identified a clear need to better highlight financial benefits of deep renovation related to energy and indoor environment quality (IEQ) performance. A more consistent and detailed information sharing between energy and environmental engineers/consultants on one side and real estate financial experts, banks and financial analysts on the other side could help mobilize further investment and improve market financing conditions.

## The ALDREN methodology for financial valuation – Indicators and information sharing

ALDREN has developed a methodology for financial valuation of renovation action, which focuses on the

This project has received funding from the European Union's Horizon 2020 research and innovation programme under grant agreement 754159. The sole responsibility for the content of this paper lies with the authors. It does not necessarily reflect the opinion of the European Commission (EC). The EC is not responsible for any use that may be made of the information it contains.



provision of relevant ALDREN sustainability metrics (energy, IEQ) and detailed technical and performance information about renovation actions to financial analysts. ALDREN specifies which indicators and information should be shared alongside the most relevant financial information for building valuation (such as the building's lease structure or local market data, including rental values, rental growth rates or duration to let).

Reflecting sustainability-related information on financial value and risks **strongly depend on local market conditions as well as the property itself and lease terms**. Estimating those conditions requires a specific expertise from real estate experts and assessors which is beyond ALDREN's scope. ALDREN specifies which financial indicators should be collected and taken into account, not how they should be evaluated in asset valuations: ALDREN does not override the expertise of qualified real estate experts, financial analysts and assessors who have to follow special legal or professional rules. However, ALDREN aims to show to all stakeholders involved in decision making process towards renovation the impact of energy related renovation by presentation of some partial financial indicators.

The ALDREN methodology is composed of two parts:

- A list of indicators, including definitions, sources of data and protocols for their calculations. A **new risk indicator related to the obsolescence of non-renovated buildings** has been introduced.

- A guidance protocol for the incorporation of these indicators into financial valuation studies for renovation decision-making, in close combination with ALDREN's Renovation Roadmap that identifies renovation actions, packages and steps over time [1]

To select the most relevant indicators, three main financial types of direct and indirect benefits from deep energy related renovation have been identified:

- Global benefits from energy costs savings and potentially extending beyond the energy savings, to encompass reduced maintenance costs and replacement costs in life cycle approach / **Direct benefits**
- Asset attractiveness, property value / **Indirect benefits**
- Reduced risks for the providers and investors and better conditions for loans / **Indirect benefits**

**Direct benefits are directly cashed by the occupant or owner:** costs savings that can be easily expressed (e.g. energy costs, maintenance costs, replacement costs) and have a direct impact on cash flows.

**Indirect benefits result from benefits to other stakeholders:** increased asset attractiveness, reduced obsolescence, higher rents and lower risk of vacancy, which result from preferences of tenants and investors and thus also from local market conditions.

This has led to a selection of indicators related to global costs, financial value and financial risks (Figure 1)

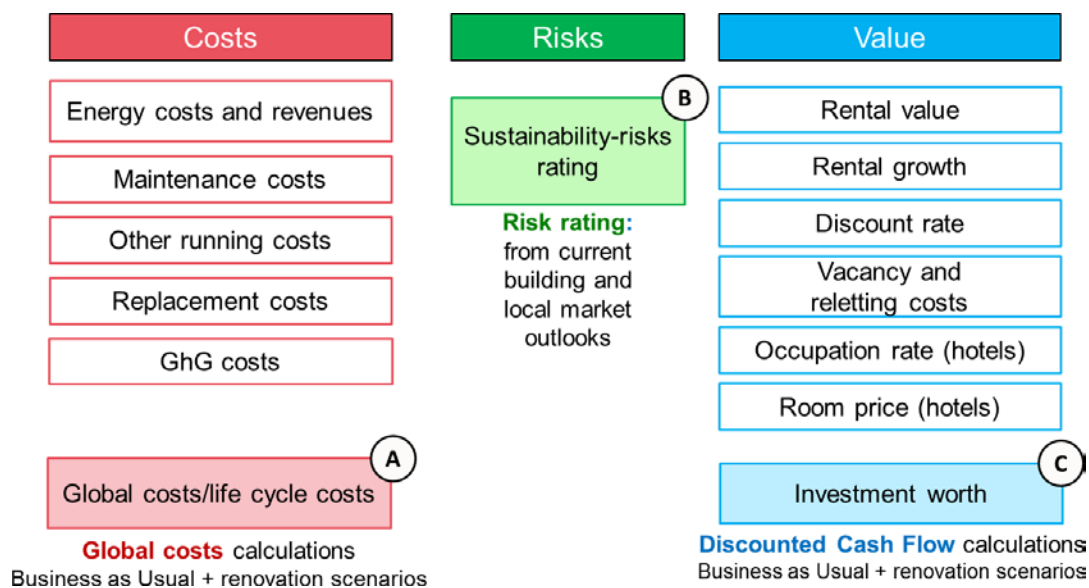

Figure 1. Selection of key economic and financial indicators.

## Financial comparisons between renovation scenarios

One of the main objectives of ALDREN’s financial methodology is to compare impacts from different renovation scenarios on the financial value of a building, to help owners decide when to invest in deep renovation.

Two main steps are presented on Figure 2:

- **initial appraisal, business as usual scenario** (Step 1 on Figure 2): appraising the financial value of an existing building if no major refurbishment is undertaken
- **renovation decision making process** (Step 2 on Figure 2): appraising and comparing several deep renovation scenarios. The latter are based on the renovation packages reported in the ALDREN Renovation Roadmap with different scheduling of major renovation steps.

Comparing several scenarios based on the same set of elementary renovation actions and packages [2] answers key concerns: is it more interesting to fully renovate the building now or in 10 years? Is it better to wait and do a complex deep renovation at once or to plan several renovation steps with successive renovation works on different years?

Investment worth (value) is the indicator that is calculated for each scenario. According to International Valuation standards, it is defined as “*The value of an asset to a particular owner or prospective owner for individual investment or operational objectives.*” This indicator measures the benefits associated with the ownership of the building, encompassing benefits which may not be fully reflected in standard market analyses but are relevant to the owner. Investment worth has been chosen instead of Market Value, which is rather used for transactions and for accountability purposes.

The calculation method is the Discounted Cash Flow (DCF) method over a 15–20 years long calculation period, in which forecasted cash flows (earnings and costs) are discounted back to the valuation date. It is consistent with international practices used in real estate valuation and recommended in best practices since it allows for a more transparent integration of benefits associated with major investments in energy, health and comfort performance, while accounting multiple effects on the different value drivers.

The key difficulty is to adjust key financial parameters in the DCF calculation, such as the discount factor, with information provided by other ALDREN modules about the building’s performance (such as

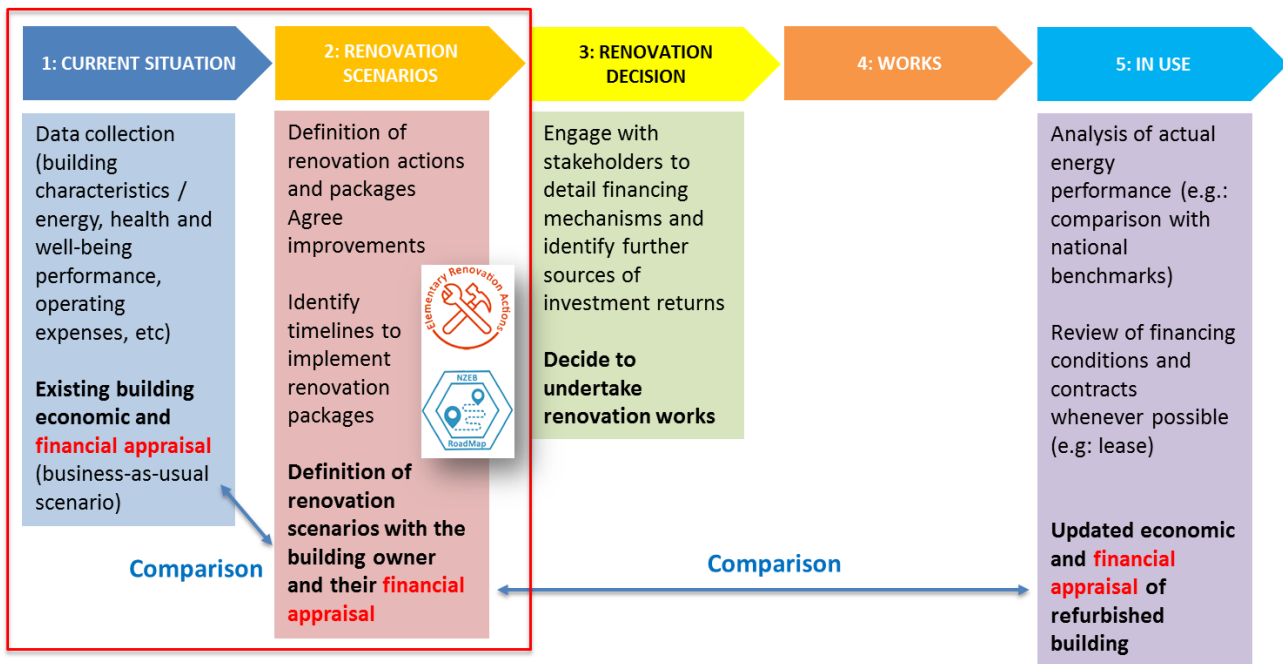

Figure 2. Overview of the ALDREN guidance protocol for financial valuation of renovation scenarios.

energy performance ratings and TAIL-rating). This is not done through a formula.

Deeply renovated well-equipped buildings tend generally to benefit from a better attractiveness, competitive rental values, and lower risk rates which relate to parameters in the DCF calculation. The assessment of such parameters depends strongly on local market conditions and should be accurately examined by qualified real estate valuers, based on market evidences.

The ALDREN approach is therefore to pass information about energy and IEQ to real estate valuers/financial analysts. ALDREN reporting tools such as the ALDREN EVC or the Building Renovation Passport (BRP) can be shared, as shown in Figure 3. Valuers then analyze local market conditions, lease terms and opportunities and evaluate parameters of the DCF calculations with their own methods: they translate ALDREN detailed technical information into financial parameters of the ALDREN evaluation protocol for the Investment Worth indicator.

Sharing detailed and holistic information contained in the ALDREN EVC and BRP is a step forward by comparison with current practices.

The methodology has been tested by Cushman & Wakefield on a pilot building located in Spain.

### Risks appraisal

Another main outcome of the ALDREN methodology is to provide a simple and consistent risk rating for the banking sector, to appraise and compare buildings in terms of technical and financial obsolescence.

Banks can play a leading role in deepening renovation by promoting and providing financing for energy improvements. Banks and other financial market players may finance sustainability upgrades in the building stock through different means:

- mortgage transactions and other secured lending for the property
- specific loans for sustainability upgrades: this would occur for example when an owner asks for a loan to renovate its building
- corporate lending and debt financing: owners may issue bonds to finance among other things their real estate portfolio. Sustainability-related features may be included in this bond issuance. This is typically the aim of Green Bonds.

Lenders have a clear interest in better assessing the risks of their investments, including risks associated with energy, health and well-being performance. A risk rating would allow to assess within a single figure the potential impacts of energy, health, well-being and a good understanding of building characteristics and

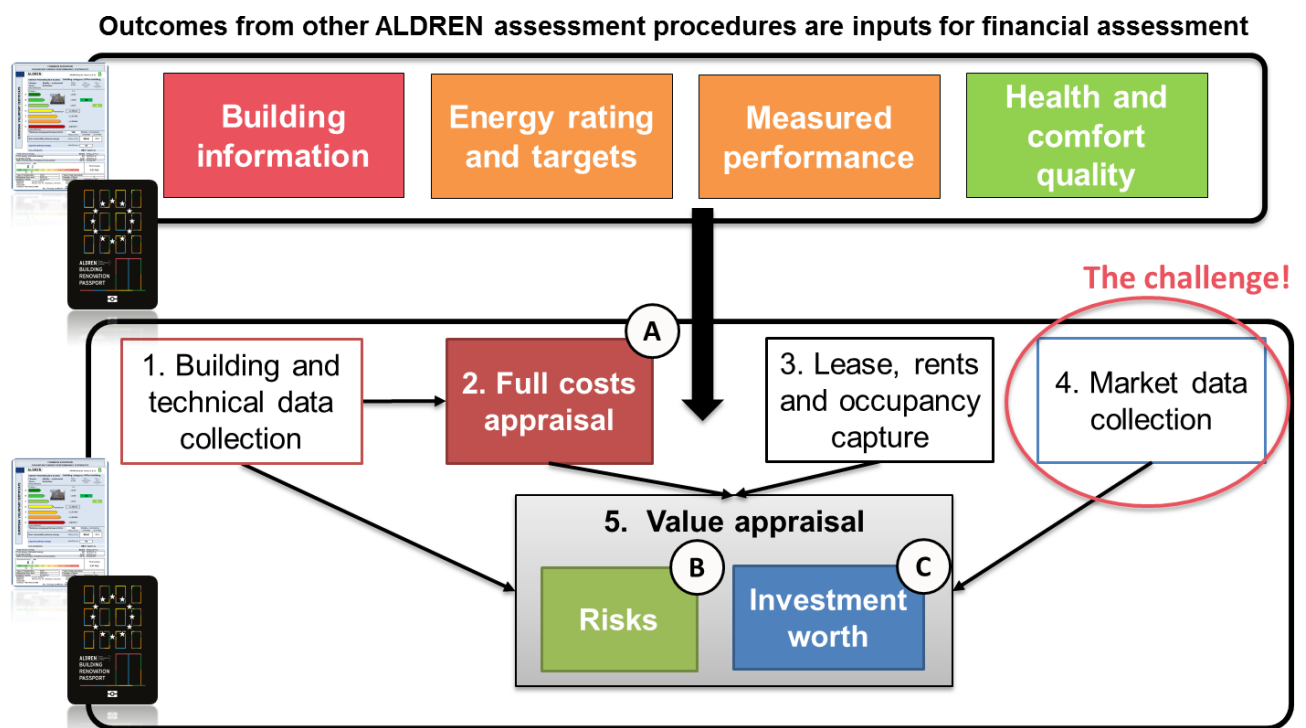

Figure 3. Information sharing between ALDREN modules on energy and IEQ and financial valuations.

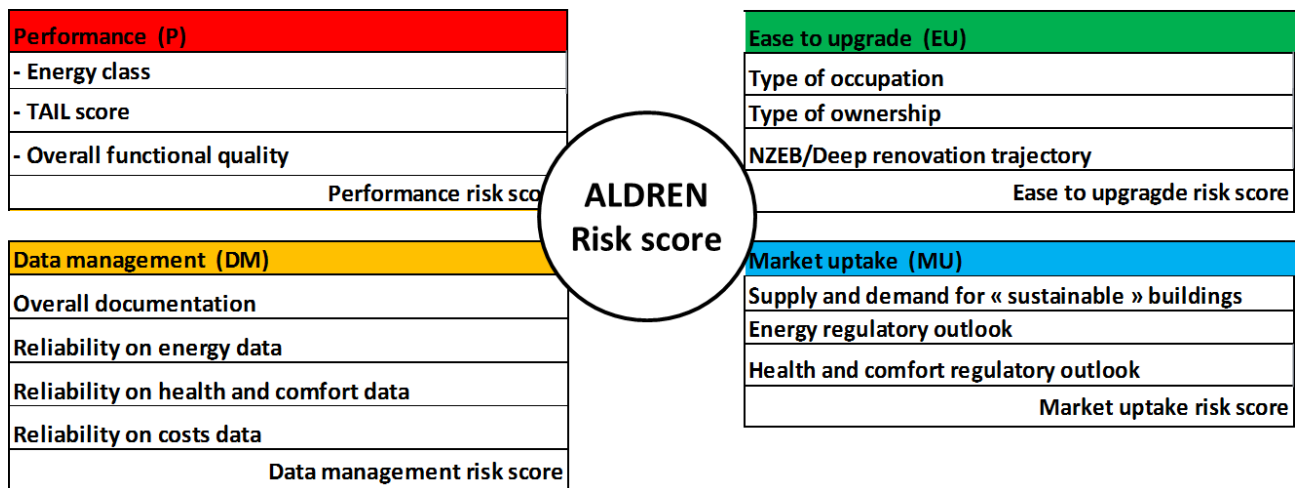

Figure 4. Sub-Indicators of the ALDREN Risk score.

pathway towards deep renovation, in terms of financial risks and futureproof quality of the asset.

Risk can be defined as "an uncertain event or circumstance that, if it occurs, will affect the outcome of a programme/project" [3]. Different types of risks exist according to the types of events or circumstances: legal risks, political risks, environmental risks, market risks, etc. Risk assessment approaches rely on investigating potential events that could negatively impact a given project/operation.

There is no standardised and widely acknowledged methodology to account for financial risks associated with sustainability-related obsolescence of building. Only a few projects and initiatives have proposed sustainability related risk rating in an asset valuation context.

ALDREN has started to develop a dedicated risk score that is based on a first simple and qualitative indicator. Risks are limited here to sustainability topics and features encompassed in the ALDREN project. The ALDREN risk rating comprises four main risk categories relating to energy performance, health and well-being performance (IEQ), energy and renovation cost management, information management. Environmental hazards, adaptation to climate change, functional obsolescence associated with new ways of working have not been considered.

Evaluation of the ALDREN risk score is based on a questionnaire that is currently being consolidated, regarding scoring and display of results, with possibility of weightings that could be introduced. The main sub-indicators are presented on Figure 4.

## Conclusion

ALDREN proposes a methodology to better highlight energy, health and comfort topics into financial valuation of building assets, risk appraisal for investors and decision-makers and renovation decisions.

ALDREN helps overcoming three main barriers:

- To address financial market players with their own language
- To be easily integrated into current building valuation practices
- To help better integrate sustainability criteria into investment decisions for deeper renovations

ALDREN's methodology is transparent and based on a consistent and thorough review of existing reference international financial standards. It may:

- Help increase awareness about environmental issues among financial analysts,
- Provide a new framework for environment-related data analysis,
- In the long term, participate to shifts in market practices, especially on the financial level. ■

## References

- [1] The ALDREN Renovation RoadMap is presented in a separate article about the ALDREN Building Renovation Passport in this REHVA Journal Special Issue.
- [2] As explained in our article about the ALDREN Building Renovation Passport and Renovation Roadmap.
- [3] Management of risk, 1st edition – RICS guidance – RICS, 2015.



### Interview with Chayma Oueslati

Senior Consultant,  
Valuation & Advisory,  
Cushman & Wakefield, France



## Introduction

Cushman & Wakefield is a world leader in commercial real estate, which creates unique added value for its clients, investors, and businesses, by combining international dimension and local expertise. Cushman & Wakefield's European valuation & advisory (V&A) team counts more than 600 experts and provides sophisticated advice on real estate equity and debt decisions to clients. The department capa-

bilities span valuation and advisory services relating to acquisition, disposition, financing, and financial reporting.

Cushman & Wakefield's French valuation & advisory team is one of the national leaders with over 80 experts working throughout the country. Its expertise embraces all types of assets for major French and international portfolios.

# CUSHMAN & WAKEFIELD

IDEAS INTO ACTION



**45,000**

Employees



**\$ 191BN**

In transaction value



Offices in more than

**70**

Countries



**CONFIDENTLY GLOBAL**

**EXPERTLY LOCAL**

As a global firm, Cushman & Wakefield valuation and advisory department is always up-to-date with environmental issues and their impact on real estate markets. In 2018, the French team took a step forward by implementing an innovative approach to assess the effects of environmental data on real estate assets. This approach is based on technical analysis, market expertise, and finan-

cial modelling. It aims to provide decision-makers with accurate risk analysis and adequate sustainable solutions.

Chayma is an architect, urban designer, and real estate expert. She is currently based in Paris as part of Cushman & Wakefield Valuation and Advisory team.

Chayma graduated from the ESSEC business school. Her research and expertise focus on the impact of environmental data and climate change on real estate markets and valuation strategies.

Cushman & Wakefield has been involved in an ALDREN pilot study in collaboration with several partners of the ALDREN Consortium to assess the impacts of energy renovation strategies on a Hotel located in Benidorm – Spain. This study aimed to measure the financial impacts of several renovation packages in terms of value, cash flow, and return on investment, in order to help the building owners make the best technical and financial decisions.

### Risk identification

#### Physical risks

- Major events,
- Weather changes,
- Etc.

#### Risks of transition

- Economic dynamics
- Regulation,
- Energy consumption,
- Etc.,

### Cash-flow

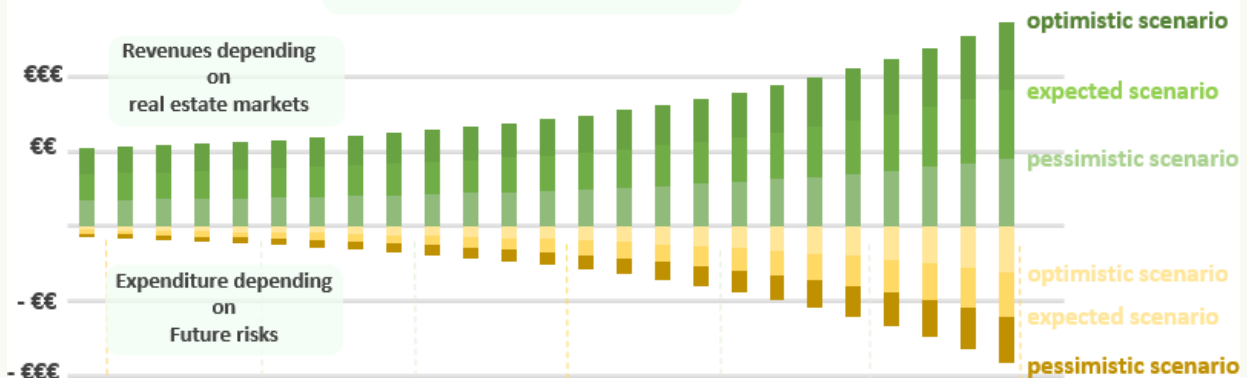

### Property value

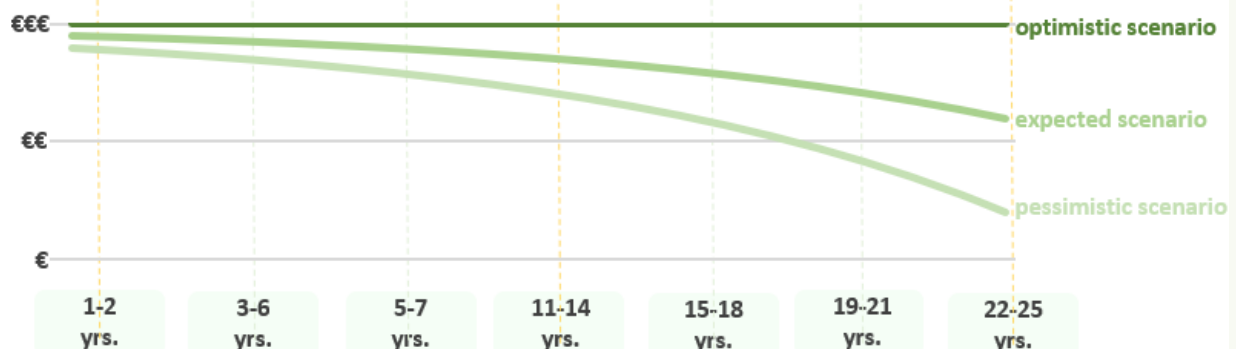



### Risk Analysis

|                   | 1-2 yrs.                                   | 3-6 yrs.                    | 5-7 yrs.                    | 11-14 yrs.   | 15-18 yrs.   | 19-21 yrs.  | 22-25 yrs.  |
|-------------------|--|-----------------------------|-----------------------------|--|--|---|---|
| Flood             | [Progressive color bar from light to dark] |                             |                             |  |  |   |   |
| Heatwaves         | [Progressive color bar from light to dark] |                             |                             |  |  |   |   |
| Marine submersion | [Progressive color bar from light to dark] |                             |                             |  |  |   |   |
| Physical Impact   | - Prevention                               | -Maintenance<br>-Prevention | -Maintenance<br>-Prevention | - Short-term<br>vacancy<br>- Maintenance<br>- Prevention | - Short-term<br>vacancy<br>- Maintenance<br>- Prevention | - Long-term<br>vacancy<br>- Repair<br>- Maintenance<br>- Prevention | - Long-term<br>vacancy<br>- Repair<br>- Maintenance<br>- Prevention |
| Financial Impact  | €  | €€                          | €€                          | €€   | €€€  | €€€   | €€€€  |

### Decision making

#### Assets vulnerability

#### Cost/benefit analysis

Low vulnerability



Assets to be preserved

Medium vulnerability



Assets to be preserved after technical improvements

High vulnerability



Assets to be avoided

**1. What are the current trends and expectations in the real estate market with regards to sustainability and climate risks? How is environmental quality recognised by investors today and reflected in the financial value of building assets?**

– Concern over sustainability and climate risk issues has been growing in recent years. Buildings with green certifications, high energy efficiency and good indoor

air quality are becoming increasingly attractive not only for investors but also for occupiers. This trend is encouraged, first of all, by the overall awareness that we have today regarding the environmental issues and how they relate to the build environments.

In this respect, well designed and equipped buildings may offer several competitive advantages on the finan-

cial, regulatory, and qualitative levels. For instance, in France, regulation related to energy consumption reduction, is nowadays starting to reshape the way investors consider their long-term projects. This new parameter that may at first seem constraining, can be, if well studied and analysed, an excellent lever to preserve and enhance the value of the building.

The advantages of implementing sustainable measures may also other benefits, even if not directly related to the property: enhancing the overall image of the company, attracting stakeholders that share the same values, and gaining advantages in terms of funding, etc.

All these parameters are increasingly recognized by real estate actors and will be more considered in the coming years.

## **2. Investors often prioritize building upgrades with short term impacts over renovation decisions with time horizons longer than ten years. What are the key challenges you are facing when predicting the impact of energy renovation on financial value?**

– Investing in sustainability could be costly in the short-term but compensated mainly in the long term. The challenge we face, as valuers, is that the market could be quite challenging to predict for the next 15 or 20 years, especially for non-typical locations or properties.

On the other hand, we cannot either predict exactly how regulation, consumption trends, and occupiers' needs will evolve in the future.

But it should be noted that even in regular valuation tasks, we face several uncertainties.

To overcome these limitations, we rely on our market expertise to identify the general trends and elaborate the most likely scenarios, to better inform management decisions.

## **3. How do you bring changes in your valuation practices to better integrate environmental risks while considering the more immediate needs of investors?**

– In order to achieve accurate environmental valuations, we use detailed technical and financial data. For this, we rely on our expertise, but also on the contri-

bution of other specialists (i.e. climate and building experts).

As said before, we also develop several valuation scenarios to study the vulnerability of each building and identify the most suitable enhancement and protection works.

We are also very open to the suggestions of our clients and partners, and we can adapt to their expectations and needs. Every meeting is an excellent opportunity to learn from each other. Integrating environmental metrics in financial valuations is not an easy task, and there is a lot to be explored, discussed, and put into action. But we are happy to take this challenge and to raise awareness about these new possibilities in the real estate sphere.

## **4. ALDREN provides a holistic evaluation protocol of a building's current and future energy and IEQ (Indoor Environmental Quality) performance after renovation. It is based on reliable sustainability metrics and a renovation roadmap. How can you use this information in your financial evaluations to better inform investors?**

– Quantified data is key for accurate valuations. The information provided by ALDREN, for the pilot study mentioned before, was very clear, useful, and directly implemented in our valuation tools. We integrated the sustainability metric in our valuation to assess their financial impact (in terms of cash-flow, value, ROI, etc.) on several renovation scenarios and we also referred to the renovation agenda provided by ALDREN's Renovation Roadmap. Overall, the protocol was very easily adopted by our teams, and without a doubt, brings a high added value for assessing the impacts of sustainability measures.

## **5. What should be the next steps in linking energy and IEQ performance to financial value of building assets?**

– Technical and financial analysis constitute an excellent starting point to implement renovation works. In my opinion, the next step would be to discuss and analyse all the experiences acquired during and after the implementation of sustainability measures. This will allow us to draw the most useful lessons and improve our valuation tools.

# The ALDREN Building Renovation Passport for Non-Residential buildings: a modular digital instrument to support the Renovation Wave



**MARTA MARIA SESANA**  
Politecnico di Milano, Italy  
marta.sesana@polimi.it



**GRAZIANO SALVALAI**  
Politecnico di Milano, Italy  
graziano.salvalai@polimi.it



**SIMON LIGIER**  
CSTB, France  
simon.ligier@cstb.fr



**MATHIEU RIVALLAIN**  
CSTB, France  
mathieu.rivallain@cstb.fr

**Keywords:** Building Renovation Passport, Building Logbook, Renovation Roadmap, modular structure, non-residential buildings

Building renovation is therefore central to the post-COVID 19 economic recovery and was specifically referred to in the recovery plan published by the EC on 27 May 2020. The ALDREN project aims at avoiding the risk of lock-in effects by developing ALDREN Building Renovation Passport and testing its respective protocols on non-residential buildings pilots.

## The Renovation Wave and the ALDREN outcomes challenge

Europe faces a momentous challenge in view of the full decarbonization by 2050 as stated in the

European Green Deal and the renovation wave initiative will address current low decarbonization rates of around 1% across the EU and tackle the underlying barriers for improving the energy efficiency of the EU building stock. Currently, roughly 75% of the building stock is energy inefficient, yet almost 80% of today's buildings will still be in use in 2050. The ALDREN goal is to avoid the lock-in effect and to the deep renovation of non-residential buildings, providing a tailored Building Renovation Passport for non-residential buildings to undertake into account homeowners' needs, desires and financial risks. At the same time, the lockdown made even more evident

This project has received funding from the European Union's Horizon 2020 research and innovation programme under grant agreement 754159. The sole responsibility for the content of this paper lies with the authors. It does not necessarily reflect the opinion of the European Commission (EC). The EC is not responsible for any use that may be made of the information it contains.



the need to have a building stock climate - resilient, climate-proof, comfortable, safe and adaptive to the owners' needs. If we consider all those aspects in a unique greater picture, it derives the urgent need to set up a long-term renovation plan with modular, flexible and comprehensible instruments. In this framework, the ALDREN project proposes the ALDREN Building Renovation Passport (BRP) as a solution to boost the Renovation Wave. The H2020 ALDREN project began in November 2017, before the introduction of the Building Renovation Passports were mentioned in the Energy Performance of Buildings Directive (EU 2018/844), but it is fully in line with the EPBD context. Deep renovation is a complex process that involves a complete overhaul of the energy performance of a building. Most people are aware that better insulation of walls, roofs and basement will lower the energy consumption of the building. However, many people are not aware how to plan renovation, which measures to adopt, when and how much does the intervention cost. In this context, the ALDREN project has the goal of encouraging property owners to undertake renovation of existing buildings using a clear, robust, and comparable method providing a tailored renovation roadmap for non-residential buildings, which can be carried out in one stage or in multiple steps over several years: the so-called ALDREN BRP.

## Key factors at a glance of the ALDREN BRP

Choosing to introduce the BRP as a tool to inform, motivate and incite building owners and investors to undertake energy renovation, is a manner by which governments can bring tangible support to consumers, boosting from one hand the energy renovation rates and depths, but also taking care of their comfort and consequently reducing their overall health costs. The ALDREN BRP for **non-residential buildings** – in particular for **office and hotel typologies** – has been developed starting from a deep analysis on the available knowledge and the lessons learned from previous experiences to be a **coherent element in a common EU solution**, but at the same time to become a useful and dynamic instrument to increase data accessibility and to create more transparency along the whole renovation path with big data interoperability.

The ALDREN BRP core concept consists in the dual element of the passport: the ALDREN BuildLog and the ALDREN RenoMap, which make the passport a sort of complementary tool to the EPC with the aim to increase owners' awareness about the current technical energy performance status of their building and support them for its regular daily operation, coupled with a tailored made renovation roadmap which provide an assessment of three main KPIs represented in **Figure 1**.

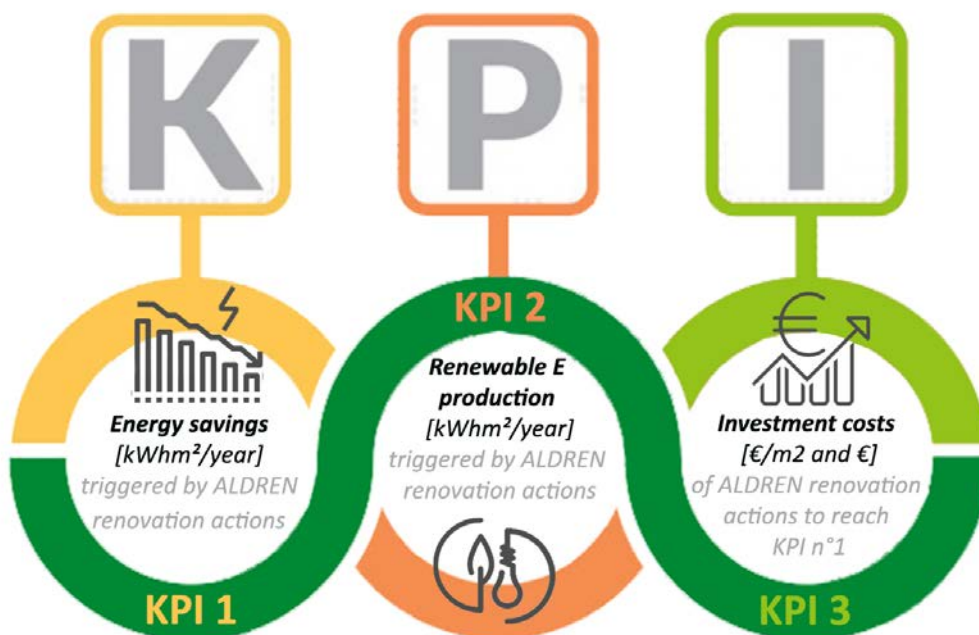







Figure 1. Key Performance Indicators calculated by the ALDREN BRP.

The whole ALDREN approach foreseen different calculation protocols for each of the modules in which the ALDREN BRP is structured and rendered in a unique instrument. The main characteristics and success factors of the ALDREN BRP are summarized in **Table 1**. One of the most important features to remark is its flexible and modularity structured based on 8 modules correlated but also independent by each other (**Figure 2**). The ALDREN auditor in fact will compose the ALDREN BRP fulfilling only the modules requested by the owner.

According to the ALDREN Alliance and stakeholders' community suggestions, in fact, the owner is one of the most important actor to be considered along the building value chain and considering that for non-residential buildings (hotel - office) could be represented by different target groups with different knowledge background, the ALDREN BRP has been developed in two versions to facilitate the use and the data comprehension: a digital version comprehensive of all data collected, calculated or evaluated during the ALDREN BRP preparation and a paper version which could provide both core and overall indicators according to the reader (owner or public authorities or auditor).

*Table 1. ALDREN BRP success factors.*

|                   |   |   |
|-------------------|---|---|
| <b>PRINCIPLES</b> | <p><b>COMPLIANCY</b></p>  <p>Digital - paper instrument, complementary to the EPC and structured into 2 main elements: BuildLog and RenoMap.</p>  | <p><b>HARMONIZATION</b></p>  <p>Harmonized procedure for building data gathering through the time, with a common language in a cost-effective renovation long-term plan.</p>  |
| <b>TARGET</b>     | <p><b>BUILDING TYPOLOGY</b></p>  <ul style="list-style-type: none"> <li>- Data sets for non- residential buildings (hotels/offices).</li> <li>- BRP structure suitable also for residential= BuildLog + RenoMap</li> </ul>                   | <p><b>ENERGY TARGET</b></p>  <ul style="list-style-type: none"> <li>- Follow the ALDREN protocols steps for BRP creation.</li> <li>- Collect users willing and use them for the RenoMap creation.</li> </ul>   |
| <b>USERS</b>      | <p><b>OWNER/ INVESTOR</b></p>  <ul style="list-style-type: none"> <li>- Refer to a unique instrument.</li> <li>- Comprehension of real current state of the building.</li> <li>- Awareness on the renovation actions feasibility.</li> </ul> | <p><b>ALDREN AUDITOR</b></p>  <ul style="list-style-type: none"> <li>- Refer to the ALDREN protocols guidance for the BRP creation based on step by step procedure.</li> <li>- Collect users willing and use them for the RenoMap creation.</li> </ul> |

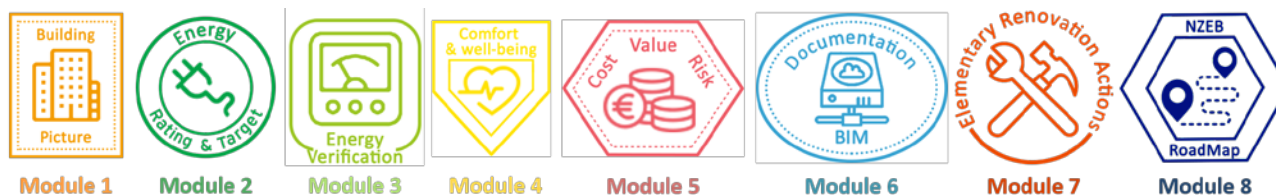

**Figure 2.** Structure representation of the digital worksheet version of the ALDREN BRP.

**Figure 3** illustrates the structure and the options available for both versions.

The creation of the ALDREN BRP will follow a step by step procedure as represented in **Figure 4** which will lead to the creation of a tailored made BuildLog and RenoMap easily update through the time.

## Building Logbook: current ongoing initiatives and the ALDREN BuildLog

Across EU there are different buildings logbook ongoing initiatives such as: the Woningpas in Belgium, the Gebäudepass in Germany, the Carnet numérique du logement in France, Fascicolo del fabbricato in Italy and CASA+ in Portugal. In order to promote their common implementation, under the EU Green Deal, the EC stated the need to develop a framework which can harmonize all these initiatives and it funded a study, the B-LOG project, to create a European-wide definition and concept of a buildings' digital logbook, carrying out an overview of relevant initiatives, conduct a gap analysis and produce 3-4 key recommendations for implementation by the end of 2020. The ALDREN consortium is contributing to this project joining the stakeholder community as a win - win solution: from one hand sharing lessons learned from the ALDREN Building Logbook experience and from the other achieving the ALDREN principles of compliancy and harmonization with other EU initiatives and directives. The B-Log project, as first result, has individuated a common agreed definition for the building logbook: a digital repository where a building's main properties (ownership, building design, materials used, structures, installations, systems, adaptations, investment, operational and maintenance costs, health and safety, performance indicators, certifications, etc.) can be compiled and updated when necessary throughout the life of the building, granting an easily accessible and comparable overview of a specific building. The comparative analysis on the in-place initiatives on logbook highlighted moreover that they are all still facing with many barriers for further implementation or harmonization like: costs implications, privacy and data management, fragmented regional approach, static nature of the building logbook, administrative burden and access to information.

Over the life cycle of buildings and at different stages, a lot of valuable data and information are generated and gathered (e.g. design, construction, operation, renovation, maintenance) and with different objectives or reasons (e.g. regulatory compliance, cost manage-

ment, operation and management, insurance, finance). However, this information is largely not organized and managed in a systematic way. Some information only benefits few market players; sometimes information has to be re-created several times and often almost none stays in the hands of property owners. Information is spread over many places and tools for safely storing, digitizing and updating information are largely missing [1]. The ALDREN BuildLog for those reasons has been structured into 6 modules with specific and respective protocols to follow for their fulfillment independent from one to another but at the same time they could share data, in order to optimize the information collection process. The BuildLog could facilitate access to structured information about how the building was originally designed, what changes have been made and what is its actual performance service level and planned maintenance.

## The RenoMap

The optimized embedding of energy performance actions in the refurbishment processes of non-residential buildings is a central goal of the ALDREN project. Completing the logbook, the ALDREN BRP also integrates a renovation roadmap (RenoMap) module. This tool and the related methodology allow the building owners to plan long term strategies for the renovation of their building following the ambitious energy performance requirement toward 2050 NZEB buildings objectives.

As a part of the ALDREN BRP, the RenoMap provides the necessary overview and long-term perspective to enhance the management of non-residential buildings. Renovation and upgrading processes have to be integrated among many operating constraints, also considering financial views as building valuation and rental management. Many questions arise when a refurbishment project is considered. What is the priority considering energy performance improvements? How to stage the renovation actions? What will be the investment cost and the financial impacts? How to be in line with existing and coming regulations? Are the changes going to improve comfort and functional qualities in the building?

The RenoMap aims at replying to these questions among others. It integrates the other developments and methodologies from the ALDREN project, using the proposed performance indicators related to standard and actual energy performance, financial valuation and indoor environment quality.

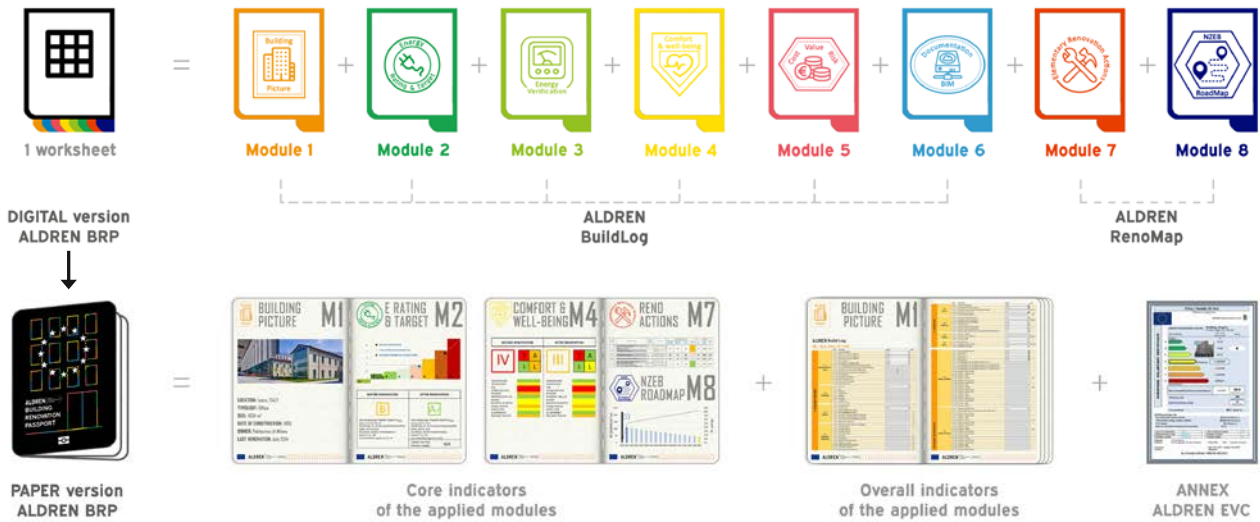

Figure 3. Representation of the ALDREN BRP digital and paper version content.

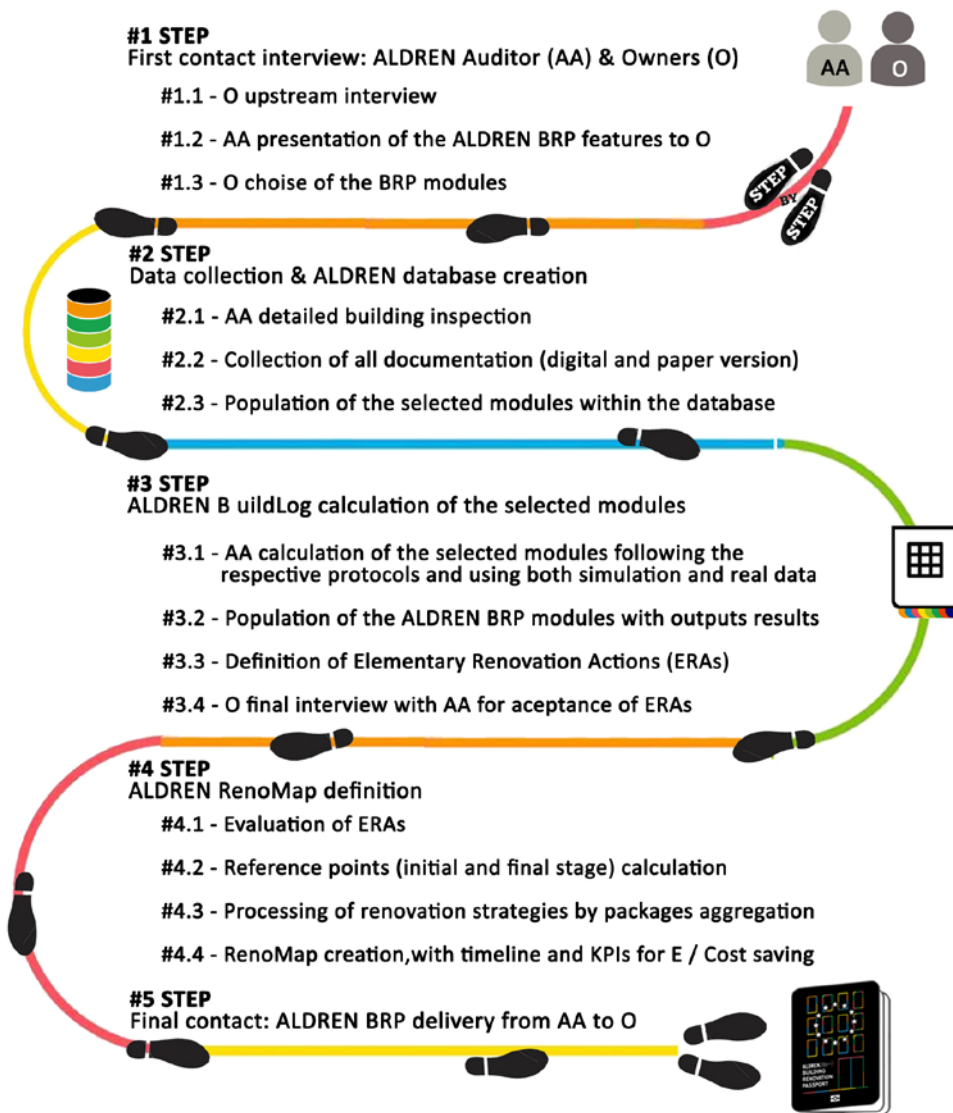

Figure 4. Steps diagram for the ALDREN BRP creation.

The proposed approach is easily implementable to support the owners' choices during the decision phase of an initiated renovation project. The RenoMap aims at reaching different objectives, both related to the coming project and the building lifetime:

- Providing a complete overview of the NZEB compliant elementary renovation actions (ERAs) which could be implemented on the building.
- Setting and evaluating a complete building renovation potential considering the application of all ERAs.
- Identifying primary packages of renovation actions to implement in the initiated project, considering components degradation, owners priorities, return on investment, energy performance and technical interactions.

- Setting a long-term plan and organizing the renovation packages according to technical requirements and opportunities (tenants replacement...)
- Evaluating performance indicators of the potential intermediate renovated states to provide the building owner the information to shape the initiated renovation project by integrating more or less renovation packages.

The tool is divided in two modules, the evaluation table of elementary renovation actions and the step-by-step renovation roadmap. The first part is based on information collected during the energy audit and the owner interview. The definition and evaluation of ERAs is based on annexes providing support concerning NZEB level compliancy and qualitative performance levels of building components.

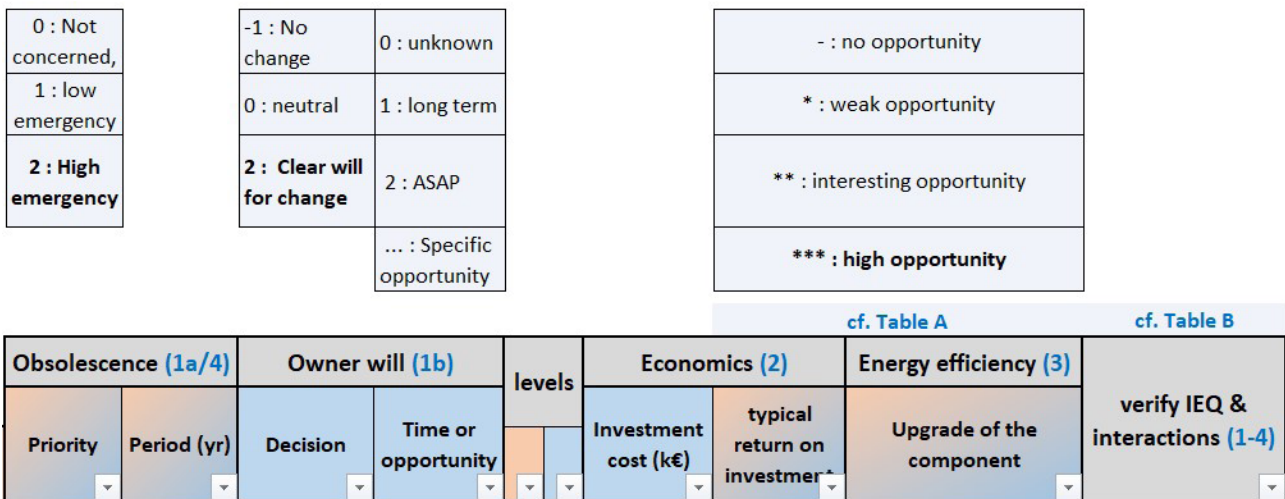

Figure 5. Qualitative indicators to evaluate Elementary Renovation Actions in the 1st RenoMap module.

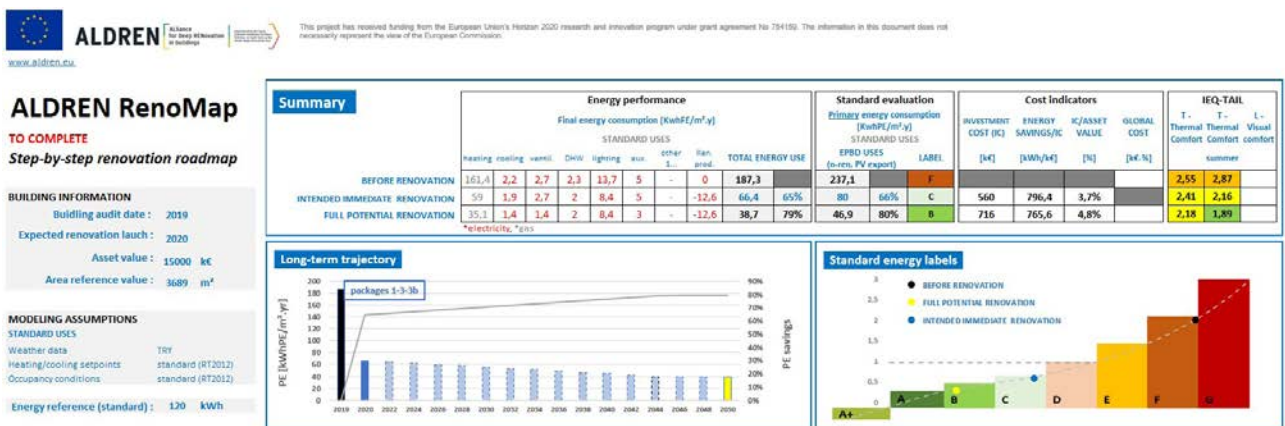

Figure 6. Summary board of the 2nd RenoMap module – Step-by-step renovation roadmap.



The second module consolidates advanced information. Energy simulations and ALDREN methodologies must be conducted to evaluate current and fully renovated building states. The gathering of packages following strategy guidance aims at accompanying the building owner in the decision-making process.

## Conclusions

The ALDREN project has the goal of encouraging building renovation using a clear, robust, and comparable method providing a tailored renovation roadmap, which can be carried out in one stage or in multiple steps over a long-term vision: the so-called ALDREN BRP. The implementation and use of ALDREN BRP will support and improve the following aspects:

- reduction of administrative burden for owners and professionals;
- reduction of the need to recreate information over the life cycle of the building;
- avoid of the lock-in effect and reduction of information asymmetries along the building supply chain;
- identification of more realistic operation and maintenance costs of the renovation actions;
- common taxonomy and languages from the different actor of the value chain;
- improvement of cost management, facilitating decision-making and building operation and maintenance, and assessing mortgage and insurance-related risks;

- improved energy and environmental performance and user comfort. ■

## References

- [1] Et.al. "Global trends in data capture and management in real estate and construction", RICS, Nov. 2017
- [2] ALDREN (Alliance for Deep RENovation in buildings) <https://aldren.eu/>
- [3] European Union: Directive 2012/27/EU of the European Parliament and of the Council on Energy Efficiency, 16 October 2012.
- [4] The Economist, Investing in energy efficiency in Europe's buildings. A view from the construction and real estate sectors, 2013.
- [5] B-LOG project First Stakeholder Workshop, BPIE Europe, 1 July 2020.
- [6] Directive (EU) 2018/844 of the European Parliament and of the Council of 30 May 2018 amending Directive 2010/31/EU on the energy performance of buildings.
- [7] M.M. Sesana; M.Rivallain; G. Salvalai, Overview of the Available Knowledge for the Data Model Definition of a Building Renovation Passport for Non-Residential Buildings: The ALDREN Project Experience, Sustainability 2020, 12(2), 642.
- [8] M.M. Sesana; G. Salvalai, A review on Building Renovation Passport: Potentialities and barriers on current initiatives, Energy and Buildings, Volume 173, 15 August 2018, Pages 195-205.

## Air Filtration in HVAC Systems REHVA EUROPEAN GUIDEBOOK No.11

This Guidebook presents the theory of air filtration with some basic principles of the physics of pollutants and their effects on indoor air quality while keeping the focus on the practical design, installation and operation of filters in air handling systems. It is intended for designers, manufacturers, installers, and building owners. With its theory, practical solutions and illustrations, this guide is also an excellent textbook for higher vocational education and training of technicians and specialists in building services engineering.

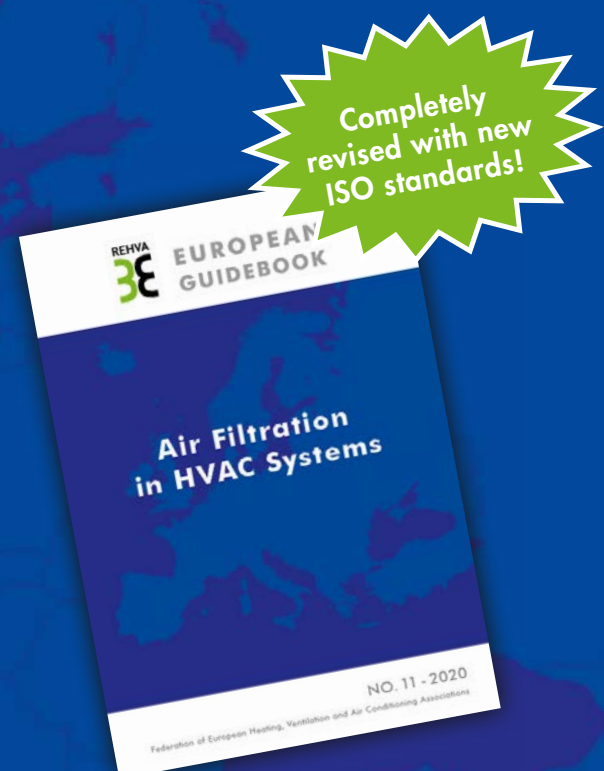

# Implementing ALDREN outcomes in the renovation sector:

*interviews with Patrick Nossent, Mayte García Córcoles and Isabel de los Ríos Rupérez*

The ALDREN pilot program has tested the different protocols developed to ensure their quality and reliability towards a future market uptake or direct use by all the stakeholders related to building renovation across Europe. For that reason, the consortium started to look for non-residential building candidates located all over Europe, fine tuning the whole procedure in a real context.

20 buildings from Belgium, France, Italy, Slovakia, Spain and United Kingdom have been selected due to their specific conditions and typology. From these 20, 6 are hotel and 14 office buildings. It is essential to remark that the ALDREN procedure has been solvent and flexible enough to manage the differences between both uses and their requirements, when evaluating the energy performance and its certification.



**Interview with Patrick Nossent**  
President  
CERTIVEA



## Introduction

Since 2005 CERTIVEA delivers HQE certification for all non-residential buildings (offices, schools, hotels, retail, logistics, ...). This certification scheme considers buildings under construction, renovation and in-use. The certification process is based on audits in design, at the end of works and in-use, in order to verify the real performance of the building. The "HQE certification" is one of the main certification schemes in the world, with more than 4000 certified buildings in all continents. It's a quality certificate that is granted, through a thorough and third-party independent certification

process. It's a guarantee to have fully operational, sustainable, comfortable, healthy spaces, offering well-being to occupants.

Since the beginning of the ALDREN project, CERTIVEA consider its experience in the field of certification, to ensure that ALDREN methodologies could be used in its future certification schemes. A work has been done to see how to implement partial incorporation of the ALDREN methodology in the existing "HQE" certification.

Patrick Nossent, President of CERTIVEA, highlights in this interview the strengths of the ALDREN methodology.

## 1. What are the main market barriers facing building certification schemes?

ALDREN project make a link between sustainable improvement of buildings (energy consumption), well-being benefits for occupants, and economic gains for all parties. By this way, the ALDREN modules has shown that a deep renovation brings in the same time energy savings, improvement of health and comfort conditions, with long-term financial benefits.

One of the major interests of the ALDREN project for Certivea is to implement the scientific methodologies which result from it, in order to promote them through its third-party certification systems. This will highlight these different cross-benefits (sustainability, well-being, economy) for the final customer of the certification. The market is awaiting this third-party guarantee about these links. The HQE certification scheme offers this security, considering its rigorous process and its overall approach. That will lead to more efficient buildings, reaching really the performance expected.

This project has received funding from the European Union's Horizon 2020 research and innovation programme under grant agreement 754159. The sole responsibility for the content of this paper lies with the authors. It does not necessarily reflect the opinion of the European Commission (EC). The EC is not responsible for any use that may be made of the information it contains.



Owners recognition is a key element. The association of a mature certification scheme as HQE, with the detailed protocol of ALDREN will allow to show these crossed benefits.

**2. Given that Energy Performance Certificates (EPC) are mandatory, what benefits can it offer that buildings also have a voluntary environmental certification? What do you think about the coexistence between the mandatory energy certificate and the voluntary environmental certification schemes of buildings?**

Voluntary environmental certification schemes as HQE already coexist with mandatory energy schemes all over Europe. Voluntary certification schemes are comprehensive assessment methods that deal with all aspects of a project (energy, climate change, water, waste, biodiversity, indoor air quality, electromagnetic fields, visual and acoustic comfort, transportation, circular economy, ...) and go beyond regulations according to the objectives of the owner of the building. Mandatory energy schemes are enforceable in each country. So, objectives are different.

One of the main advantages of ALDREN methodologies is that it provides a common scale for EPC, which fits in perfectly with the needs identified above.

A combination of ALDREN's methodologies and the benefits of a mature certification scheme (HQE), is a one of the best ways to make eco-conditions more reliable and to encourage deep renovations.

**3. ALDREN's backbone is a harmonized European voluntary certification scheme that integrates the assessment of energy, health, and wellbeing performances of the building. What are the main strengths of the ALDREN methodology in your opinion?**

The main strengths of the ALDREN methodology is to make a link between energy renovations planned, the level obtained on EPC, the improvement of well-being and of building value. This is preponderant in the commitment of building stakeholders to a virtuous renovation process, showing them that energy improvement is also valued in terms of well-being and economy.

The rigorous methodologies applied also allow to have a high level of confidence in the results, which is very important for stakeholders.

**4. Which ALDREN modules/indicators/protocols do you plan to integrate into "HQE"?**

Certivéa will certainly use the different modules of ALDREN, independently and in different ways, for its certification schemes. For example, the energy thematic of HQE certification could be updated by adding the calculation protocol of task 2.2, in order to deliver also the new EPC. We will refer also to the performance verification tool developed in ALDREN, especially for buildings in use.

We will ensure that indicators used in HQE to evaluate health and wellbeing are compatible with TAIL indicators used in ALDREN. And we will also use the link made in ALDREN between renovation process and value of the building, to give this new information to our stakeholders.

A strong relationship has been created with HOSBEC (*Asociación empresarial hotelera y turística de la Comunidad Valenciana* <https://www.hosbec.com>), which provided 6 hotel buildings to test the different modules. This collaboration with the ALDREN project demonstrates the interest and commitment of its associated hotels in reducing their environmental impact and contributing to a quality and responsible tourism. Also important is IVE's certification Entity, essential to review the modules related to Energy, Health and Wellbeing and currently working to adapt part of the protocols to its certification structure and promoting the inclusion of roadmaps to track the renovation measures implemented on buildings.

IVE (Valencia Institute of Building <https://www.five.es/>), the Spanish partner in the ALDREN project, has been in charge of coordinating this fruitful relationships that resulted in a very useful feedback to prepare ALDREN towards the real building renovation market in the hospitality sector and as a set of tools that can be assumed by existing certification entities.

**Hosbec**

IVE has been in conversations with HOSBEC since the inception of the pilot programme. The buildings that finally joined the program were selected due to their need of renovation, interest towards energy efficiency and scale. All of them have been tested in terms of energy efficiency and health and wellbeing modules, elaborating bespoke renovation roadmaps that estimate the possible evolution of the building energy perfor-

mance in the following years. Only 1 of them has been used to test the whole ALDREN procedure.

Each building has different qualities and circumstances, what made the ALDREN modular approach an advantage, tailoring the renovation roadmaps with real needs. The results have been diverse and promising as the most part got an energy class close to ALDREN NZEB level, triggering the production of renewable energy and updating the building systems to the latest technologies available in the market. It is important to mention that the ALDREN procedure can be applied, too, under actual conditions, using the performance verification tool as control and managing tool of the outputs obtained during the simulation process.



**Interview with  
Mayte García Córcoles**  
Head of Quality, Training and  
Projects at HOSBEC



## Introduction

[HOSBEC](#) is the Association of Hotels of Benidorm, Costa Blanca and Valencian Community. It represents the hotel sector with the aim of increasing its competitiveness and plays a key role in the development of tourism policy. HOSBEC was founded in 1977 and currently has hundreds of associated hotels. Thanks to the collaboration established between HOSBEC and the ALDREN project, six hotels located in Spain became “Pilot buildings” in ALDREN project: [“RH Bayren & Spa”](#), [“Benidorm Center”](#), [“Poseidón Playa”](#), [“Flamingo Oasis”](#), [“Les Dunes Comodoro”](#), and [“Dynastic”](#). This collaboration confirms the strong commitment to offer Valencia region as a quality tourist destination.

The result of the research offered to the owners of these hotels detailed information about the renovation measures that should be undertaken to improve the energy performance of the building up to the nearly zero energy standard (nZEB), its impact on comfort conditions and healthiness of the occupants, as well as quantifying the market value of the building after the renovation.

**1. Until now, do you think that clients have valued knowing the energy performance and environmental impact of the hotel in which they have been staying? Can it influence when choosing one hotel or another? Are they important aspects in tourism marketing?**

– In recent years, we have been able to detect that, among the criteria employed for selecting a hotel estab-

lishment, customers have begun to value energy and environmental policies. In general, hotel companies have started to introduce these principles into their communication policies. However, only those who have been able to integrate energy policies on their management achieve that plus of differentiation.

It would be desirable that these energy-saving policies and strategies to become a nearly zero energy building (nZEB) were a reality among those buildings with the greatest expenditures. It is true that most recently built buildings are close to achieving this energy goal but buildings built more than 15 years ago did not comply with these energy measures. Hence the importance of integrating energy criteria during their renovations.

**2. The current Covid-19 pandemic has focused the attention of public opinion on the vulnerability of our cities and buildings. Do you think that the demand for safe, healthy and comfortable hotels with higher quality indoor environments will now increase? How could this impact your market?**

– I think that among the selection criteria of a hotel, it will be decisive to be able to know the degree of compliance with hygiene and safety measures. After this pandemic, certain questions about environmental quality in hotels will be highly valued by guest.

Therefore, now more than ever, hotels will start designing facilities to accomplish hygiene criteria, easy cleaning, ventilation, accessible air conditioning systems, between others.

Tourism market is facing the most significant challenge ever, and it will be crucial that everything advanced in terms of energy and sustainability helps to create customers confidence, but above all for optimizing costs.

**3. In this context, ALDREN allows to evaluate the quality and potential improvements of the indoor environment through a pragmatic rating approach based on measurements. As a whole, the ALDREN approach is modular with complimentary assessment approaches to identify renovation actions for building owners. What aspects of the ALDREN methodology would you highlight?**

– ALDREN allows to standardize a very useful methodology when planning improvements and to demonstrate that buildings can be more sustainable prioritizing those areas that improve their energy performance and consequently their emission reduction.

The hotels that have participated in pilot projects have the privilege of having information that in many cases, has allowed making more reasoned decisions, obtaining more significant savings in energy consumption.

#### 4. Eventually, what insights did you gain through ALDREN pilot studies conducted by IVE on several hotels?

– The most important conclusions that ALDREN is bringing from the pilot studies is the importance of integrating information about the building performance, which allows prioritizing actions on those areas where improvements in the energy efficiency are more relevant.

Accessing this type of projects is an opportunity for the hotel sector to improve in energy and innovation, and also demonstrates interest in the commitment and concern to reduce the environmental impact of these large energy-consuming buildings.

#### *IVE certification entity. Bes Office Certificate*

IVE certification entity has been always receptive to review the ALDREN protocols providing feedback and experience to improve the overall ALDREN procedure. On that terms, it is important to recall that BES certificate has contributed substantially at the first stages of the ALDREN project, mainly, with indicators, parameters, and methodology to kickstart the design of the M2.4, Health and Wellbeing.

Not less important is that BES certificate found very interesting the work developed on other Modules, more specifically the M2.6, renovation roadmap and logbook, the section related to Lighting in the M2.4 and the methodology developed in the M2.3, GAP measurement between estimated and real energy consumption. These 3 methodologies and parameters have been adapted and integrated into the BES certificate procedure, adding value to its structure.



**Interview with Isabel de los Ríos Rupérez**  
Responsible for the Secretariat of the IVE Certification Entity



## Introduction

Since 2017 the [IVE Certification Entity](#) offers “[BES Office](#)”, which is a certification scheme for buildings

and office premises in use, in which a company or organization is normally developing its professional activity. The “BES Office” is a quality certificate that is granted, through a thorough and independent certification process, to those workspaces that are fully operational and have environmental and spatial conditions of great influence for the well-being of employees.

Since the beginning of the ALDREN project, the IVE certification entity has been consulted on numerous occasions given its extensive experience in the field of certification. At the moment, work is being done on the partial incorporation of the ALDREN methodology in the existing “BES Office” certification.

Isabel de los Ríos, responsible for the Secretariat of the IVE Certification Entity, highlights in this interview the strengths of the ALDREN methodology.

## 1. What are the main market barriers facing building certification schemes?

– The Voluntary Certification Schemes offer added value to the evaluated building, both for the real and effective improvement that any quality control process brings to the controlled product, and for the trust that third-party certification schemes offer regarding the quality of space or construction.

If the market does not clearly recognize that a certain voluntary certification scheme guarantees this added value, it will be difficult to make an economic investment and a technical effort to implement it.

In general, I consider that the social agents involved in the building sector perceive favourably that voluntary certification schemes promote the real quality of the building and the use of certain materials, facilities or systems that significantly improve the energy performance of the building. Submitting a building to an evaluation process requires rigorous precision that, on the one hand, makes it easier for the project to contain all the information necessary to adequately define a building and, on the other, for the work carried out to be faithful to the content of the project on paper.

Public recognition is the most complex aspect to achieve since it requires the maturity of the voluntary certification scheme and the existence of evident advantages for the promoter, both commercial, financial, fiscal, etc. which are complex to implement.

### 2. Given that Energy Performance Certificates (EPC) are mandatory, what benefits can it offer that buildings also have a voluntary environmental certification? What do you think about the coexistence between the mandatory energy certificate and the voluntary environmental certification schemes of buildings?

– Voluntary environmental certification schemes can and should coexist with mandatory energy schemes, as long as they value aspects that are different and innovative in energy matters, or environmental aspects that are complementary to purely energy aspects.

We are talking, for example, of incorporating requirements on water consumption, the use of sustainable materials, the establishment of limit values in parameters of environmental comfort such as air quality, noise, spatial configuration, etc., all of them aiming, not only at protect the environment, but to improve the well-being of the occupants or users.

### 3. ALDREN's backbone is a harmonized European voluntary certification scheme that integrates the assessment of energy, health, and wellbeing performances of the building. What are the main strengths of the ALDREN methodology in your opinion?

– ALDREN offers a detailed and rigorous methodology to evaluate both the current state of the building under

study and the improved state according to the planned energy renovation.

In addition, it is a methodology which aims to improve the evaluation of the energy performance of buildings and bringing computer models closer to the built reality. This aspect is key and represents one of its greatest strengths, which, logically, is well received by professionals who are dedicated to improving the quality of buildings in general and promoting efficient renovation.

### 4. Which ALDREN modules/indicators/protocols do you plan to integrate into "BES Offices"?

– Thanks to ADREN we are updating environmental parameters such as some relating to air quality, but fundamentally the Energy Saving requirement is being updated, expanding the range of features that can be chosen to achieve BES certification.

The BES Offices Design Guide will expand the aspects related to how energy audits and monitoring should be and will incorporate a feature aimed at promoting the drafting of roadmaps for the continuous improvement of the building in terms of its energy performance.

## Hygiene in Potable Water Installations in Buildings

– Requirements for design, deployment, operation and maintenance

### REHVA EUROPEAN GUIDEBOOK No.30

The interrelationships between water quality, health and the well-being of users require that all parties involved have a specific responsibility for aspects of hygiene in specifying the requirements for potable water installations in buildings. This guidebook gives an overview about the fundamentals of hygiene and water quality and contains main information's on the design, installation, start-up, use, operation and maintenance of potable water installations in buildings. It gives also suggestions for the practical work (maintenance, effects on microbiology, potential causes and measures in practical work, checklists).

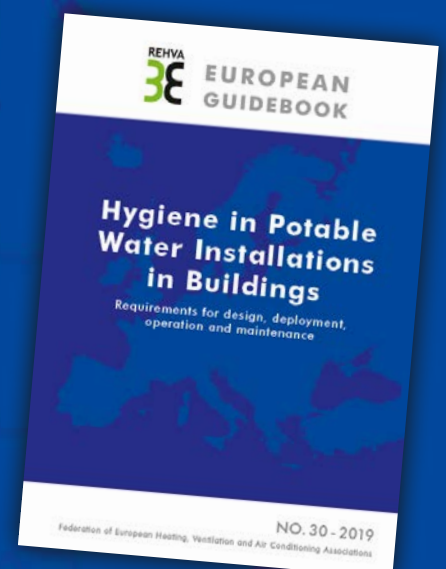

# Heat Recovery from Sewer System in a Sport Complex



**DOMINIKA MACKOVÁ**

Slovak University of Technology  
Faculty of Civil Engineering  
Department of Building Services  
d.juhosova@gmail.com



**JANA PERÁČKOVÁ**

Slovak University of Technology  
Faculty of Civil Engineering  
Department of Building Services  
jana.perackova@stuba.sk

In the paper there are introduced the possibilities of the recovery of waste heat from the sewer system as an answer to the minimalism of the demand of energy needed for the preparation of domestic hot water. The recovery of waste heat from the sewer system is possible using heat exchangers in order to extract heat from wastewater to direct preheating of cold water.

**Keywords:** heat recovery; heat exchanger; sewage, sewer system, sanitary equipment; wastewater, domestic hot water, sport complex, shower

Nowadays, more and more energy is consumed in buildings for preparing hot water, heating, cooling of the building and thus energy became very valuable. The energy consumption for heating and cooling purposes decreases thanks to the thermal insulation of the building constructions and replacement of old windows for new plastic windows with triple glazing, while the energy consumption for preparing hot water is constantly increasing. How the energy needed to heat the potable water could be reduced? One option is recuperating. We are able to recover waste heat from the sewer system to preheat

domestic hot water using heat exchangers. Heat from wastewater can be optimally used for heating, cooling and hot water preparation in low- energy houses.

## Recovery of waste heat from the sewer system inside of the building

Buildings with a constant flow rate of wastewater and significant amount of it being drained away are suitable for heat recovery directly inside them. In this case, it is very convenient to use the heat from the sewage for preheating water for immediate consumption. The

This work was supported by Slovak Research and Development Agency and the Ministry of Education, Science, Research and Sport of the Slovak Republic through the grant VEGA 1/0847/18 and KEGA 044 STU-4/2018.



MINISTRY  
OF EDUCATION, SCIENCE,  
RESEARCH AND SPORT  
OF THE SLOVAK REPUBLIC

system is based on heat exchangers, which serve to exchange the heat energy between the waste water and the cold water. There is no contact between the potable water supply and the drain water [1].

Figure 1 shows the fundamental principle of system of recovery of waste heat from sewage inside of building to direct preheating of domestic hot water. Wastewater from shower with a temperature  $38^{\circ}\text{C}$  is drained into the sewerage through the heat exchanger. The cold water with the initial temperature  $10^{\circ}\text{C}$  flows through the heat exchanger, in the opposite flow direction of the drainage water, and is transported into the thermostatic shower mixer tap. Wastewater transfers the heat through the heat exchanger into the cold water in order to preheat it – cold water can reach a temperature of approximately  $20^{\circ}\text{C}$  [1].

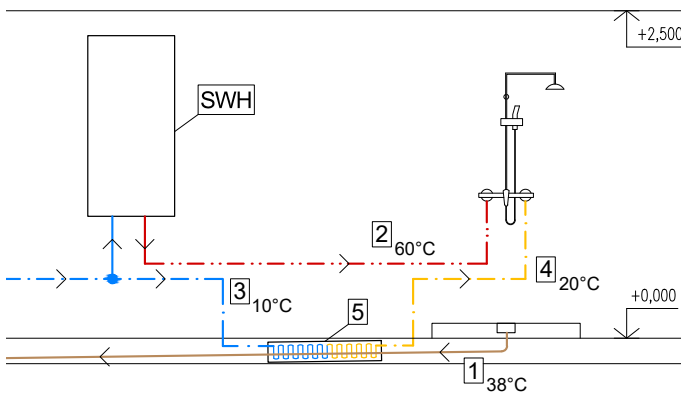

Figure 1. Cold water preheated for immediate consumption through heat exchanger [author].

1 = waste water drained from the shower ( $38^{\circ}\text{C}$ ),  
 2 = hot water supply from the storage water heater ( $60^{\circ}\text{C}$ ),  
 3 = cold water supply to the heat exchanger ( $10^{\circ}\text{C}$ ),  
 4 = preheated cold water supply to the shower thermostatic mixer tap ( $20^{\circ}\text{C}$ ),  
 5 = heat exchanger,  
 ZOV = storage water heater.

Preheated water is supplied into the thermostatic shower mixer tap. Adding the preheated water into the thermostatic mixer instead of cold water, a smaller portion of hot water is mixed with a larger portion of preheated cold water thus reducing the hot water flow. This serves to reduce the hot water consumption and energy needed for water heating [2]. The recovery of waste heat to direct preheat of hot water is recommended for sanitary appliances where the need for hot water exceeds the need for cold water – the best example are showers and wash basins.

Heat exchangers could be installed in a several ways. Heat exchangers should always be installed as close to the sanitary appliance as possible. Methods of installation are as follows [1]:

#### a) *direct connection of one heat exchanger to one sanitary appliance (shower)*

The waste water from one sanitary appliance (e.g. one shower) flows through the heat exchanger into the sewerage. The cold water flows in the opposite direction of the sewage water and is supplied into the mixer tap as the preheated water in order to reduce the hot water flow.

#### b) *direct connection of one heat exchanger to several sanitary appliances (shower and wash basins)*

The waste water drained from the shower and washbasins flows through one common heat exchanger into the sewerage. The preheated water is supplied into the thermostatic mixer tap of the shower and also into the mixer taps of washbasins.

#### c) *combined connection of the heat exchanger with a storage water heater*

In this case, the preheated cold water is not only supplied into the thermostatic mixture tap, but it is also transported into the local storage water heater which serves to save energy needed for hot water preparation. This type of installation is the most effective one in terms of energy savings.

#### d) *parallel connection of the heat exchanger to several sanitary appliances*

Sewage from many showers flows into the sewerage through one common sewer pipe into many heat exchangers. With this type of installation, as many heat exchangers are installed as many sanitary appliances there are - heat transfer is more efficient.

### Types of heat exchangers for recuperation of waste heat from

Several types of heat exchangers for recuperation from the internal sewerage systems are known - heat exchanger in combination with a shower with floor drain system [4] (see point A), special shower trays with integrated heat exchanger [5] (see point B), heat exchanger in the form of regenerative panel placed under the shower tray [6] (see point C), regenerative panels with stainless steel heat exchanger [3] (see point D), etc. In the rest of this article, alternative solutions of the recovery of waste heat in the object of a sport facility are applied.



**A. Heat exchanger in combination with a shower with floor drain system**

Application: This alternative is suitable for sanitary equipment with showers, where a shower with a floor drain system is designed (Figure 2a). The heat exchanger is in a form of a double walled stainless-steel heat exchanger. The energy efficiency depends on the hot water flow [4].

Principle: Figure 2b shows a floor plan of the sanitary equipment with showers with a floor drain system where the recuperation is provided by a compact heat exchanger. The sewage water from the shower (38°C) flows into the sewerage through a heat exchanger by a connecting pipe in the floor. The cold water (10°C) is preheated (20°C) and supplied directly into the thermostatic shower mixer. Hot water is prepared locally. Pipes for cold water and drain of wastewater are laid in the floor.

**B. Shower tray with integrated heat exchanger**

The second recuperation system consists of a special shower tray with the heat exchanger integrated underneath the shower tray (Figure 3).

Application: If in the object is a shower designed with a shower trays, the option is recuperation using this special shower tray with an integrated circular heat exchanger in the form of spiral of copper pipes (Figure 3a). The heat exchanger is placed under the shower tray, but the normal height of shower tray is maintained. The efficiency depends on the hot water flow and is around 41% [5].

Principle: Figure 3b shows a floor plan of the sanitary equipment where the heat recovery is solved using a shower tray with an integrated circular heat exchanger through which the wastewater flows. The cold water (10°C) is supplied into the shower tray from the bottom of the heat exchanger.

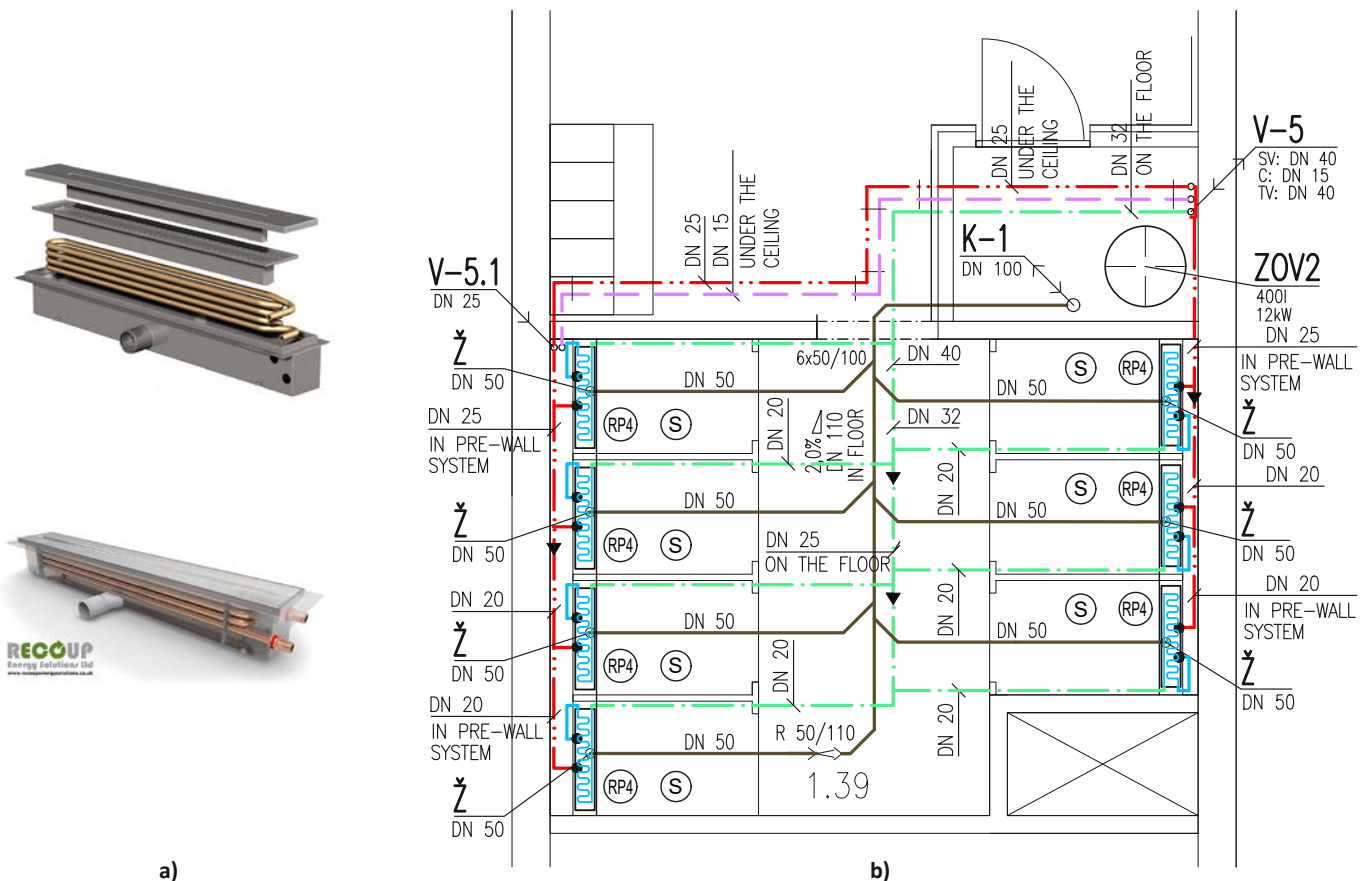

**Figure 2.** Recovery of waste heat using a heat exchanger in combination with a shower with floor drain system. a) view to the heat exchanger [4], b) floor plan with an application of this heat exchanger. V = rising pipe of cold water, hot water and circulation of hot water, K = foul water stack, ZOV = water heater, Z = shower with a floor drain system, RP4 = heat exchanger in a combination with floor drain system, S = thermostatic shower mixture tap. [author]

- cold water (10°C)
- preheated cold water (20°C)
- hot water (60°C)
- wastewater (38°C)
- circulation of hot water (55°C)

**C. Heat exchanger in the form of regenerative panel placed under the shower tray**

Application: If in the object is a shower designed with a shower tray, another option is using this regenerative panel with plastic casing and heat exchanger made of a copper pipe [6] (Figure 4a).

Principle: Figure 4b shows the sanitary equipment floor plan where the heat recovery is solved using a regenerative panel placed under the shower tray. The wastewater (38°C) is drained through the panel placed under the shower tray, on the floor. Cold water is supplied through the heat exchanger in order to preheat it, preheated water is supplied to the shower mixer.

**D. Regenerative panels with stainless steel heat exchanger**

This recuperation system consists of a heat exchanger in the form of regenerative panel [3].

Application: This alternative could be used in sanitary equipment where showers without shower trays are designed. This panel consists of a plastic

waterproof case and a stainless-steel heat exchanger (Figure 5a). The heat exchanger is placed on the floor, as close to sanitary equipment as possible. The regenerative panel is available in two versions: 630 mm long version and 1320 mm long version.

Principle: The wastewater from the shower (38°C) flows through the heat exchanger placed in the thermal insulation layer of the floor. Figure 5b shows a floor plan with an alternative solution of heat recovery when the cold water is supplied into the thermostatic shower mixer tap through the heat exchanger and heat from wastewater is extracted and transferred into the cold water (10°C) in order to preheat it (20°C). I suggest using a 630 mm long recuperation panel for one shower and one longer recuperation panel with a 1320 mm length for recuperation of sewage water from two showers.

Figure 5c shows a floor plan with an alternative solution of heat recovery by using heat exchangers with their parallel installation. For three showers I suggest the parallel connection of three heat exchangers through which the water will be preheated for three shower ther-

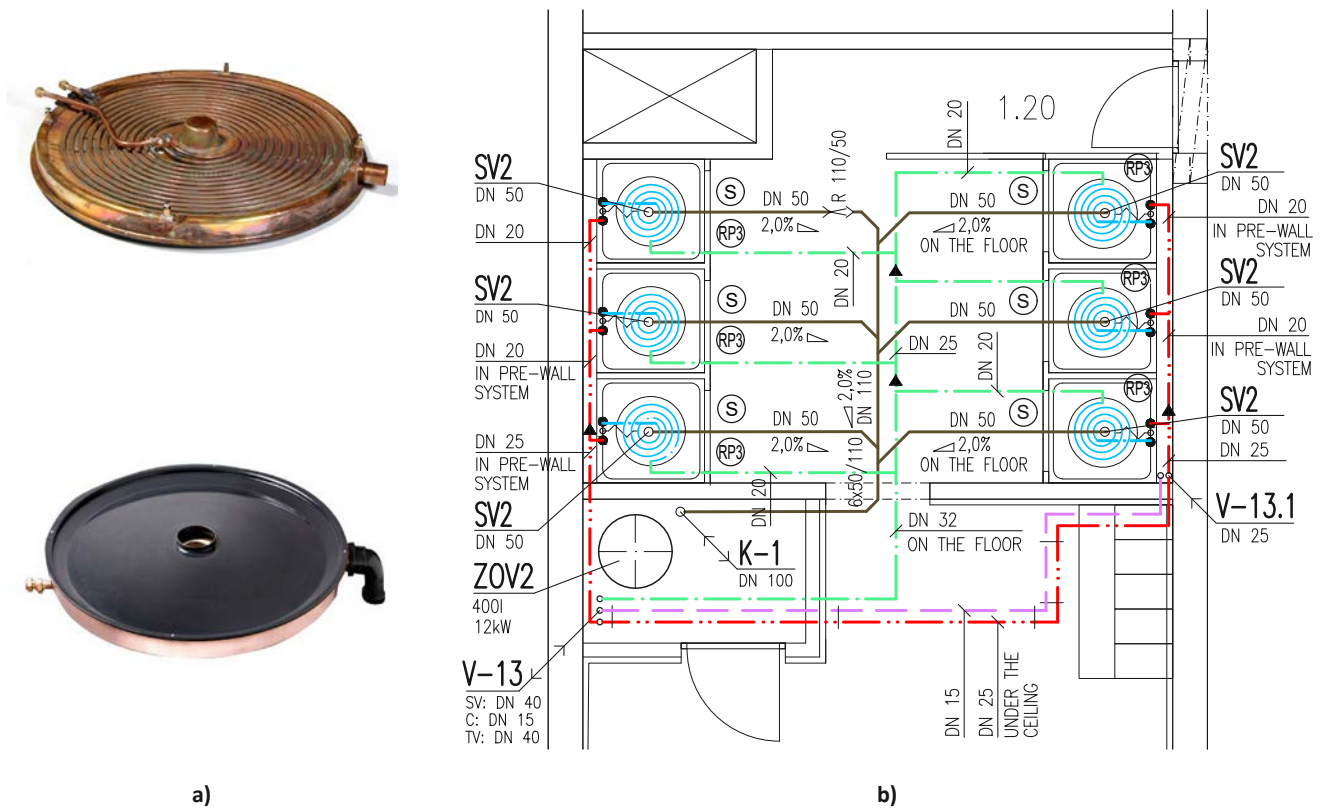
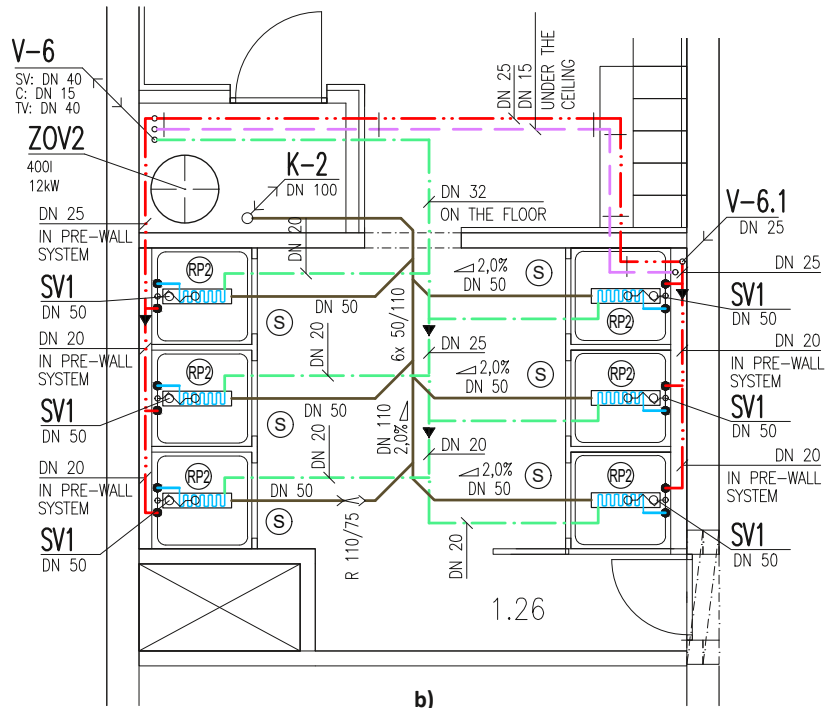

Figure 3. Floor plan with alternative solution using a shower tray with integrated heat exchanger. a) view to the heat exchanger [5], b) floor plan with an application of this heat exchanger. V = rising pipe of cold water, hot water and circulation of hot water, K = foul water stack, ZOV = water heater, SV2 = squared shower tray with drain in the middle, RP3 = shower tray with integrated heat exchanger, S = wall-mounted thermostatic shower mixer. [author]



a)



b)

**Figure 4.** Alternative solution of recovery of waste heat using a heat exchanger placed under the shower tray. SV1 = squared shower tray with drain, in the middle, RP2 = heat exchanger - regenerative panel placed under the shower tray, S = wall-mounted thermostatic shower mixer.



a)

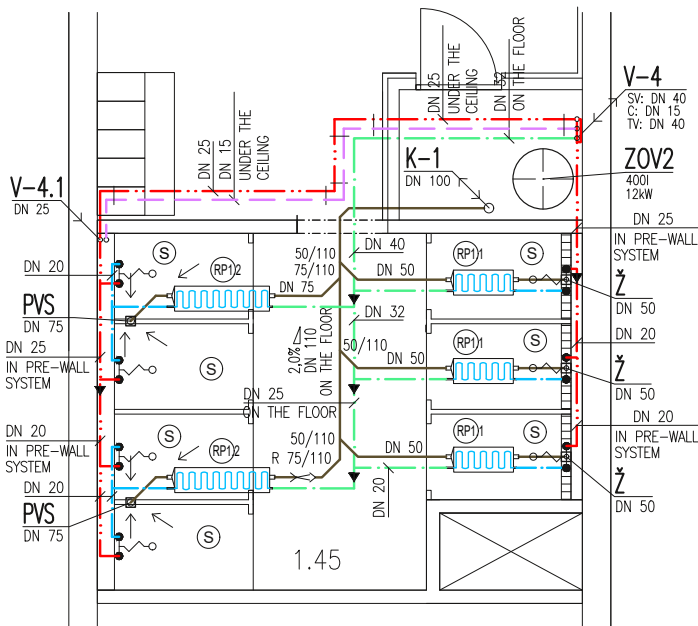

b)

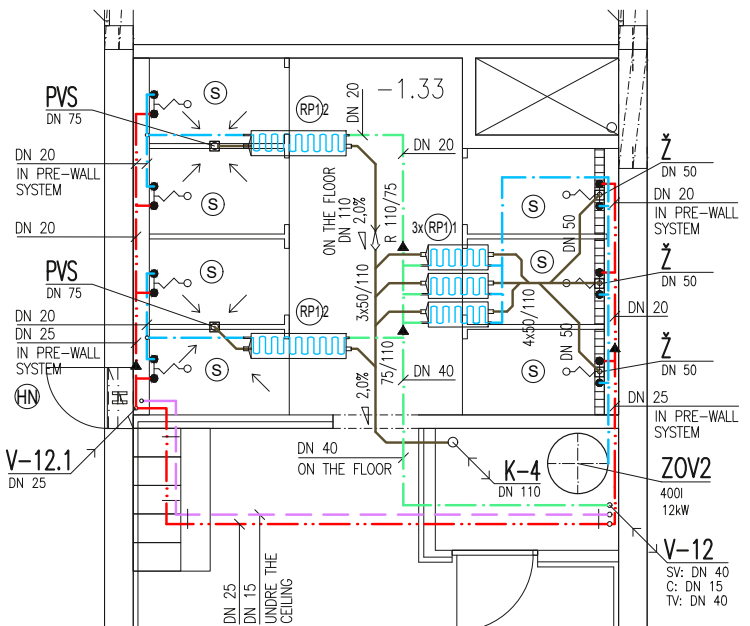

c)

**Figure 5.** Alternative solution of recovery of waste heat using a panel with stainless steel heat exchanger. a) view to the heat exchanger [3], b) direct installation, c) parallel installation of heat exchangers. V = rising pipe of cold water, hot water and circulation of hot water, K = foul water stack, ZOV = water heater, PVS = shower floor drain, RP1 = regenerative panel with stainless steel heat exchanger placed in the floor: RP1.1 = length of panel 630 mm, RP1.2 = length of panel 1320 mm. [author]

mostatic mixer taps. In this alternative solution I also suggest supplying the preheated water (20°C) **into the storage water heater**.

The contribution describes four types of heat exchangers applied in the sanitary equipment of a sport complex. The energy efficiency always depends on the flow rate of hot water and the efficiency could decrease as a result of dirt accumulating on the inside of the heat exchanger – *every heat exchanger must be maintained sufficiently*, as follows:

- every heat exchanger must be installed with a shower drain filter and trap to prevent the passage of debris. Like any other drain pipe, is strongly recommended a periodically cleaning;
- if it is necessary, the shower drain filter should be cleaned or replaced for a new one;
- the surface of the heat exchanger can become slightly fouled, it only takes a couple of minutes, once or twice a year to clean the surface using some detergent and brush.

The maintenance required for the heat exchanger is very minimal, however, it is recommended to clean the

unit periodically to avoid any reduction in efficiency. This cleaning will remove any build-up of soap and dirt residue on the inside of the copper pipe where the wastewater passes [3].

## Conclusion

The aim of article was to introduce different possibilities of using heat from internal sewerage systems and answer to the question about reducing the need for preparation of hot water. Heat recovery from sewerage systems inside of the buildings could be applied in dwelling houses and apartment flats, in sports facilities, swimming pools or factories and the advantage of these systems is that, in addition to their simplicity and price, there is no need for electricity to operate them.

In the article there are presented alternative solutions using recuperation. The options of recovery of waste heat from sewerage systems are many and these systems can also be applied in our conditions. Sewage water is full of unused energy and presents a low-potential renewable source of energy that can be used to prepare hot water or heating and cooling the building. ■

## References

- [1] Buzás, V. (2019): *Heat recovery from sewage systems*, Dissertation thesis, Faculty of Civil Engineering, Slovak Technical University of Technology in Bratislava. Bratislava, Slovakia (in Slovak).
- [2] J. Peráčková, V. Podobeková (2013): *Utilization of heat from sewage*, In Budownictwo o zoptymalizowanym potencjale energetycznym, pp. 79 - 86., ISSN 2299-8535.
- [3] Innova renewing energies. Bee the heat recovery system for hydro- sanitary systems. Available from: <https://www.innovaenergie.com> (online).
- [4] RECOUP, Recoup drain+, Drain+Compact Heat Exchanger, Available from: <https://recoupwwhrs.co.uk/products> (online).
- [5] HEI-TECH, Shower trays - The Recoh tray heat exchanger, Available from: <https://www.specifiedby.com/hei-tech/the-recoh-tray> (online)
- [6] ZYPHO Drain water heat recovery system, Available from: <https://www.zypho.eu/products/zypho-standard> (online)
- [7] SHENOY V.U.: *Heat exchanger network synthesis*. Proces optimization by energy and resource analysis. Houston: Gulf Publishing Company, 1995. ISBN0-88145-319-6.
- [8] Buri, R., Kobel, B. (2005): *Leitfaden für Ingenieure und Planer*, Institut Energie in Infrastrukturanlagen Zürich, ECO.S Energieconsulting Stodmeister, Berlin
- [9] Muller E.A., Sschmid F., Kobel B. (2005): *Heizen und Kühlen mit Abwasser*, Institut Energie In Infrastrukturanlagen Bundesverband Wärmepumpe (BWP), München
- [10] Brunk M.F., Seybold C.: *Dezentrale Wärmerückgewinnung aus häuslichem Abwasser*, Endbericht der RWTH Aachen, Lehrstuhl für Baubetrieb und Gebäudetechnik im Forschungsprogramm Forschungsinitiative Zukunft Bau des Bundesministeriums für Verkehr, Bau und Stadtentwicklung, Aktenzeichen" SF-10.08.18.7-10.4.

# Water Quality and Water Consumption in Apartment Buildings in Slovakia



**JANA PERÁČKOVÁ**  
Slovak University of  
Technology,  
Building Services  
jana.perackova@stuba.sk



**DOMINIKA MACKOVÁ**  
Slovak University of  
Technology,  
Building Services  
d.juhosova@gmail.com



**MILAN KRAFČÍK**  
Slovak University of  
Technology,  
Building Services  
milan.krafcik@stuba.sk



**ZUZANA ČERMANOVÁ**  
Slovak University of  
Technology,  
Building Services  
zuzi.cermanova@gmail.com

In Slovakia, more than 1.7 million people live in apartment buildings. The contribution focuses on the hot and cold-water consumption and quality in apartment houses in Slovakia. The first part of the paper presents the results of a questionnaire survey about the quality of hot water in individual households. The second part consists of the analysis of the hot and cold-water consumption in several apartment buildings based on the experimental observation.

**Key words:** water quality, water consumption, potable water cold, potable water hot, questionnaire survey, experimental observation, apartment house

The requirements for the water consumption have changed in comparison to the last decades. Apartment buildings in Slovakia use the primary heat sources and old distribution networks with poor insulation, and it is therefore necessary to

analyse the issue of preparation and distribution of water in residential buildings. In apartment houses in Slovakia, in order to save energy, there are different thermal attenuations and shutdowns of energy supply for water heating. However, before such a measure is implemented, it would be useful to know how the quality of the supplied hot water will change, whether the residents of apartment building agree with the measure and how effective the measure is.

## Water quality in apartment buildings in Slovakia

The first part of the contribution deals with the quality of hot water supply, which was reviewed on the basis of a questionnaire survey called “Opinions on the preparation and distribution system of hot water in Slovak households”, created on the Internet. The questionnaire evaluated the quality of the hot water in accordance with the subjective feeling of inhabitants.

The questionnaire was completed by 232 respondents living in an apartment house. In terms of age, 22% were

This work was supported by Slovak Research and Development Agency and the Ministry of Education, Science, Research and Sport of the Slovak Republic through the grant VEGA 1/0847/18 and KEGA 044 STU-4/2018.



students, 76% were working-age people and 2% were old-age pensioners [1]

### **Question 1: How is hot water prepared in your apartment building?**

To the first question, 19% respondents stated that the hot water is in their apartment building prepared using a storage water heater, 5% has a plate heat exchanger, 2% combination of a plate heat exchanger and PWH accumulation in storage water heater, 69% did not know to answer (ordinary resident does not have access to the technical rooms) and 5% said otherwise. The graphical representation is shown in Figure 1.

### **Question 2: In What condition are pipes for water distribution in your apartment building?**

To the question 2 answered 57% that the water pipes are in its original state, 24% answered that the pipe were renovated, and 19% did not know to answer.

### **Question 3: How are insulated pipes in the hot water distribution system of your apartment building?**

To the third question, 23% respondents answered that pipes in their apartment houses are well insulated, 22% answered that the pipes are insulated with old felt insulation, 6% respondents thought pipes are not insulated, and 50% did not know to answer.

### **Question 4: What is the circulation of hot water in your apartment building?**

To question 4 answered 50% of respondents that the circulation in their apartment house is uninterrupted, 19% thought it was shutting down at night, and 31% did not know to answer.

### **Question 5: What is the hot water supply in your apartment building?**

To question 5 answered 70% that the hot water supply is continuous, 21% of respondents thought it was shutting down at night, and 9% did not know.

If the choice was made by the respondents, 64% would like the hot water supply to be uninterrupted. 36% of respondents would like the circulation and the source of hot water to be turned off overnight to save energy and money, although the hot water would not be available during the night.

### **Question 6: Do you think that the hot water in your apartment reaches a temperature of at least 45°C within 30 seconds after opening the water tap?**

According to the Slovak rules, the supplier of hot water is obliged to provide the customer hot water with a temperature of 45°C within 30 seconds of opening the water tap.

77% of respondents answered that they obtain a hot water with the temperature at least 45°C and 23% of respondents answered they did not. Of all respondents living on the first to fourth floors, 19% respondents did not obtain hot water with required temperature, of all those living on the fifth to eighth floors is 21%, and of all those living on the 9th to 14th floors is 38%.

### **Question 7: How long will it take to get hot water at the desired temperature after opening the tap?**

To the 7th question, 30% answered that they obtain hot water immediately, 47% of respondents takes hot water from 15 to 30 seconds, 18% thought it would take a minute, and 5% said that after more than a minute). The graphical representation is shown in Figure 2.

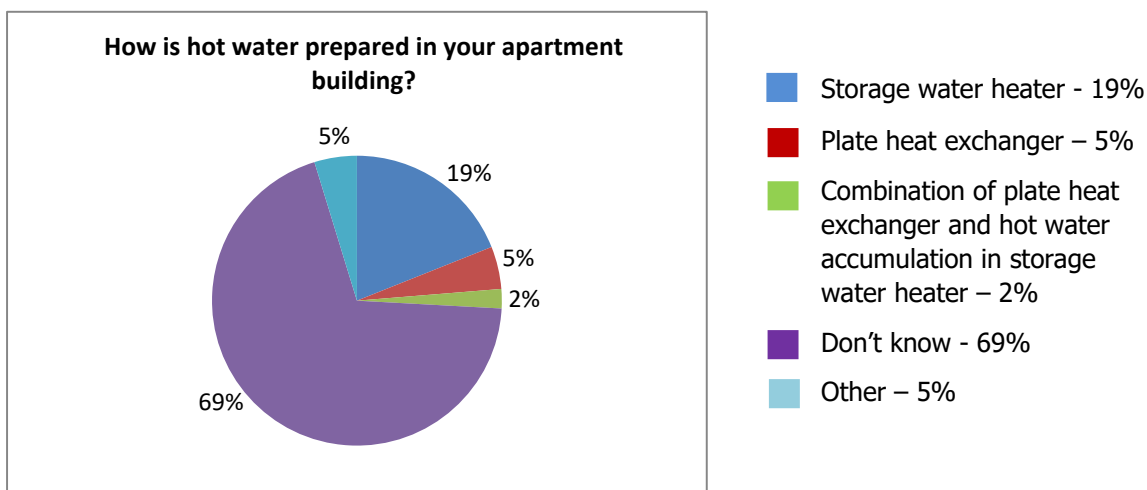

Figure 1. How is hot water prepared in your apartment building?

**Question 8: How satisfied are you with the temperature of the hot water supplied?**

To the eighth question, 45% of respondents answered that they are very satisfied with the temperature of obtained hot water, 50% are satisfied, 3% are dissatisfied and 2% are very dissatisfied. The graphical representation is shown in the Figure 3.

**Question 9: How satisfied are you with the quality of the hot water supplied?**

To the ninth question, 34% answered that they are very satisfied with the quality of obtained hot water, 60% are satisfied, 6% are dissatisfied and no one was very dissatisfied. The graphical representation is shown in the Figure 4.

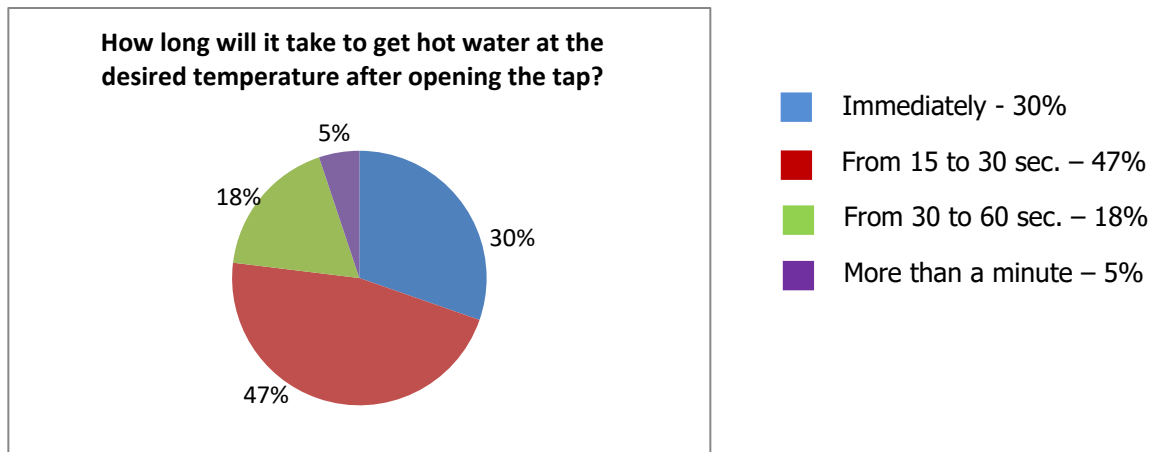

Figure 2. How long will it take to get hot water at the desired temperature?

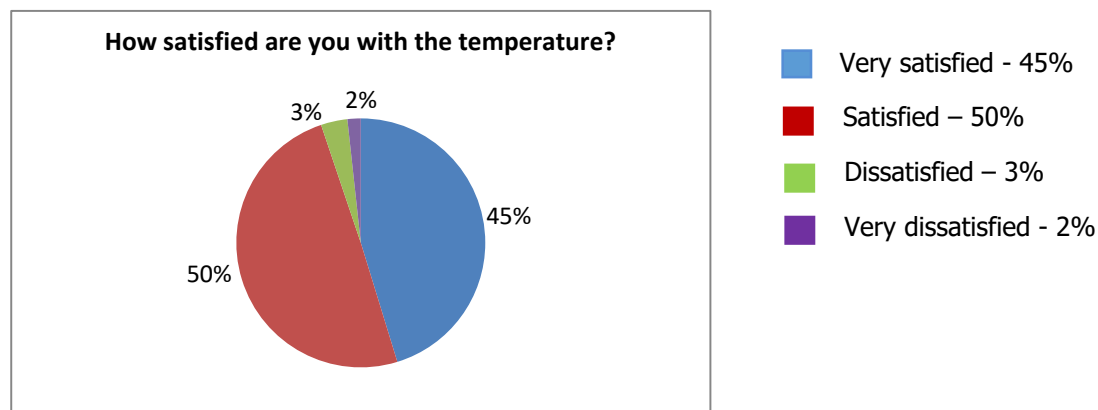

Figure 3. How satisfied are you with the temperature of the hot water supplied?

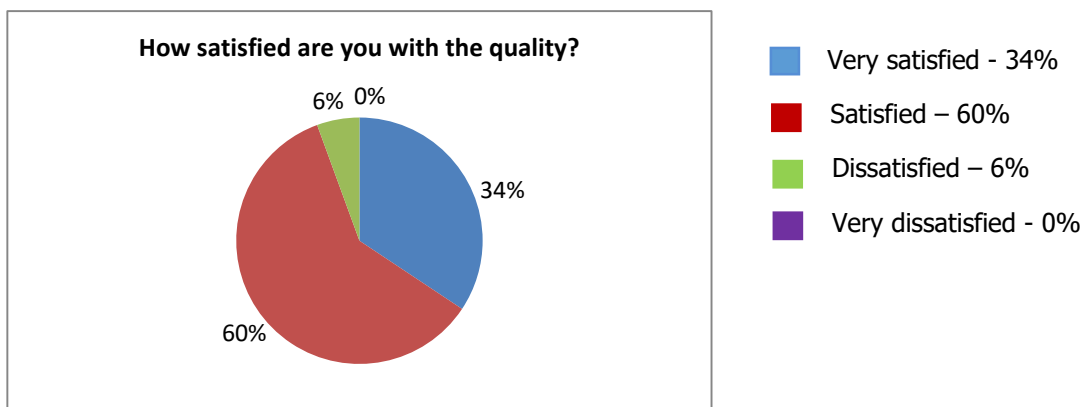

Figure 4. How satisfied are you with the quality of the hot water supplied?

### Question 10: How satisfied are you with the price you pay for the consumed hot water?

To the question 10 answered 4% of respondents that with the price of hot water they are very satisfied, 62% are satisfied, 28% are dissatisfied and 6% are very dissatisfied.

The survey showed that most of the residents of apartment buildings are satisfied with the temperature, quality and price of the hot water. The preparation of hot water is usually uninterrupted. Most residents think their hot water will reach temperature 45°C in a relatively short time. Of those inhabitants, where the temperature does not reach 45°C, the majority lives in 9th to 14th floor, which confirm that **the quality of supplied hot water decreases with the distance of the apartment from the heat source** [1].

### Water consumption in apartment buildings in Slovakia

The second part of contribution is dedicated to the hot and cold-water consumption in apartment buildings in Slovakia. The evaluation of water consumption is based on the experimental measurement of daily water consumption per the resident which was done in three selected apartment buildings. The aim of the measurement was to analyse the consumption of hot and cold-water and set the daily water abstraction peaks. Measurements were done for selected rising pipe of cold and hot water for:

- apartment building “A” located in Bratislava (capital city of Slovakia), hot and cold-water supply to 12 flats for 30 inhabitants, measured period: 08/2016 → 10/2016;
- apartment building “B” located in Bratislava (capital city of Slovakia), hot and cold-water supply to 9 flats for 14 inhabitants, measured period: 12/2016 → 02/2017
- apartment building “C” located in Prešov (city in the east of Slovakia), hot and cold-water supply to 12 flats for 27 inhabitants, measured period: 09/2017 → 11/2017.

Measured values were a flow of hot and cold-water and its temperature on the interval of 3 seconds. On the basis of the measured values, the daily average water abstraction was determined. The measuring system was located in the front of the rising pipe of the hot and cold-water [2].

### Cold-water Flows and temperature in apartment buildings

In **Figure 5** daily maximum, average and minimum value of the cold-water flow rate in litres per minute in individual apartment houses A, B and C are figured. The average flow rate for apartment house “A” was 25.4 litres per minute, for the apartment building “B” it was 23.3 litres per minute and for the apartment house “C” the average cold-water flow was 23.6 litres per minute.

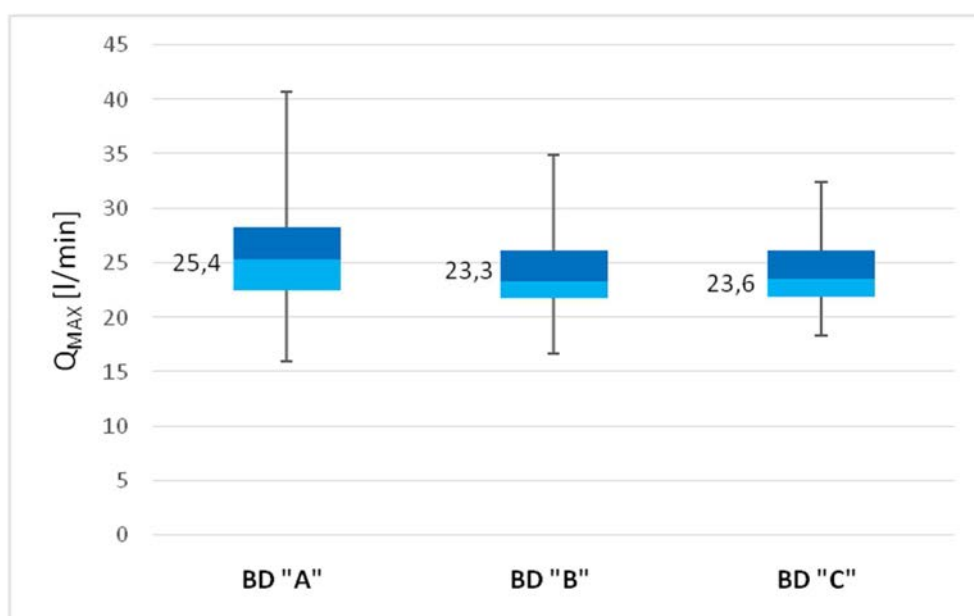

**Figure 5.** Behaviour of cold-water flows in apartment buildings A, B, C in measured periods.  
 $Q_{MAX}$  = flow rates of cold-water (litres per minute), BD = apartment building.



Concerning to the temperature, the cold-water temperature in apartment building “C” was around 10°C all the time, in the apartment building house “B” the measured average temperature of cold-water was 15°C and in the apartment building “A” the temperature of cold-water was mostly above 18.5°C, which is inadequate from the hygiene point of view.

## Hot water flows and temperature in apartment buildings

The Figure 6 shows the daily maximum, average and minimum of hot water flow in litres per minute. The average hot water flow rate for apartment building “A” was 21.1 litres per minute, for apartment building “B” 24.0 litres per minute and for apartment building “C” 23.9 litres per minute.

The temperature of hot water in apartment building “A” was from 53°C to 57°C. In residential building “B” the temperature was from 55°C to 57°C and in the building “C” the temperature was from 46°C to 48°C throughout the measured period.

From the measured data of cold and hot water flows, the average **daily water consumption** during the day were determined. An overview of the results of cold and hot water consumption in apartment buildings A, B, C is given in Table 1.

From the measured results it is obvious that the **total water consumption of cold and hot water is from 68 to 92 litres per person per day**. The average values of water consumption per inhabitant were calculated from the results of experimental measurements of the flow rate

**Table 1.** Comparison of daily consumption of cold and hot water in apartment buildings.

| Identification         | Number of inhabitants | Water consumption litre / (person.day) |           | Total water consumption litre / (person.day) |
|------------------------|-----------------------|--|-----------|--|
|                        |                       | Cold-water                             | Hot water |  |
| Apartment building “A” | 30                    | 38.25                                  | 32.36     | 70.61  |
| Apartment building “B” | 14                    | 37.26                                  | 31.28     | 68.54  |
| Apartment building “C” | 27                    | 42.01                                  | 49.48     | 91.76  |

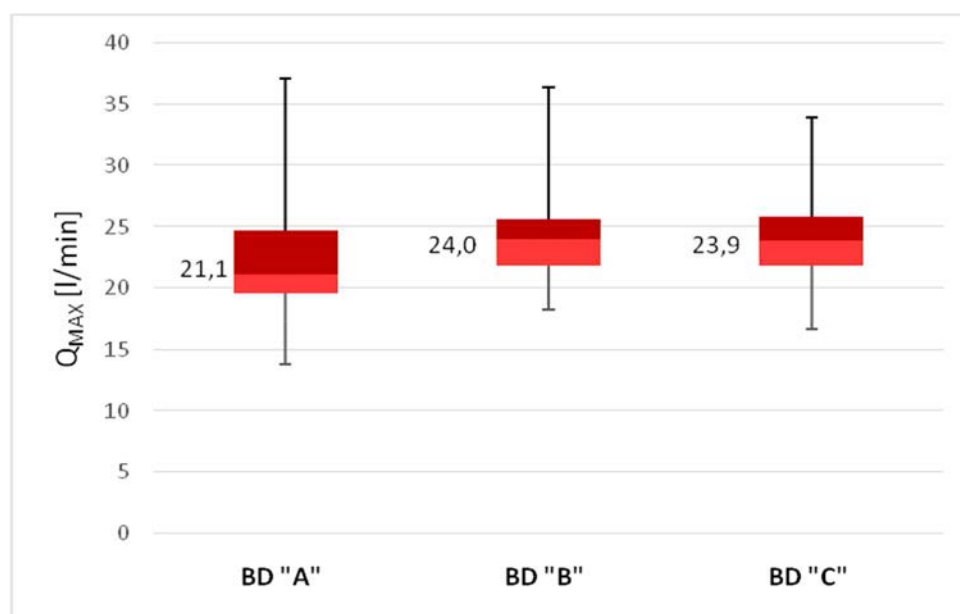

**Figure 6.** Behaviour of hot water flows in apartment buildings in measured periods.  
 $Q_{MAX}$  = flow rates of hot water (litres per minute), BD = apartment building.

and volume of supply cold and hot water. According to Slovak regulation, there is a specific water demand for the residential buildings of *135 to 145 litres per person per day*, while *real data show that water consumption is less than 100 litres per person per day*. It would be appropriate to make adjustments in Slovak regulations in the future [2].

## Conclusion

Experimental measurement of water consumption in apartment houses in Slovakia showed that the total consumption of cold and hot water for one inhabitant ranges from 68 to 92 litres per person. The values for specific water demand in Slovak designing rules for the residential buildings are oversized by about 30%. The hot and cold-water consumption peaks are always at maximum in the morning and evening both during the weekend and during the week. Weekends confirm the increased consumption of cold and hot water, as the residents of apartment buildings are in the apartment building at this time [2].

The questionnaire survey showed that residents of single-family houses, who have to take care of the hot water system themselves, are much more interested in the hot water preparation and distribution issues than residents of apartment buildings. Overall, men are more interested in this issue than women, which confirms the fact that it is men who care about the technical operation of the household. In terms of age, pensioners are the most interested in their hot water system, followed by people of working age [1].

As for the quality of cold-water, several researches done in the Department of Building Services in the Slovak University of Technology showed that in some apartment buildings in Slovakia, there is a problem with keeping the temperature of cold-water below the recommended limit of 15°C. In experimental measurements, the temperature of cold-water in the range of 18 to 20°C was measured in some apartment buildings which must be prevented by high-quality of insulation of water pipes. ■

## References

- [1] Čermanová, Z. (2015): *Consumption of hot water and energy balance of hot water's preparation in apartment houses*. In: Dissertation thesis, Faculty of Civil Engineering, Slovak Technical University of Technology in Bratislava. Bratislava, Slovakia (in Slovak).
- [2] Krafčík, M. (2019): *Water Flows and Consumption in Apartment Buildings and Usage of Stratifical Domestic Hot Water Preparation*. In: Dissertation thesis, Faculty of Civil Engineering, Slovak Technical University of Technology in Bratislava. Bratislava, Slovakia (in Slovak).
- [3] Čermanová, Z. & Peráčková, J. (2016): *Príprava teplej vody v Slovenských domácnostiach*. (Preparation of hot water in Slovak households) In: TZB Haustechnik, Vol 24. 4/2016, pp. 50-53.
- [4] Hendron, R. & Burch, J. (2007): *Development of standardized Domestic Hot Water Event schedules for residential buildings*. In: Energy Sustainability. Long Beach, California.
- [5] Hasehawa, Y. & Inoue, T. (2004): *Energy consumption in housing in the basis of national scale questionnaire: study on influence of residential characteristic and dispersion of energy consumption Part 1*. In: Journal of Environmental Engineering, Architectural Institute of Japan.
- [6] Bohm, B. (2013): *Production and distribution of domestic hot water in selected Danish apartment buildings and institutions. Analysis of consumption, energy efficiency and the significance for energy design requirements of buildings*. In: Energy Conversion and Management, pp. 152-159.
- [7] STN EN 806-2: *Specification for installations inside buildings conveying water for human consumption*. Part 2: Design. (in Slovak).

# Can radiant wall cooling be preferable solution for building retrofit?

**MICHAL KRAJČÍK**

Slovak University of Technology,  
Faculty of Civil Engineering  
michal.krajcik@stuba.sk

**DUŠAN PETRÁŠ**

Slovak University of Technology,  
Faculty of Civil Engineering

**ONDŘEJ ŠIKULA**

Brno University of Technology,  
Faculty of Civil Engineering

**MARTIN ŠIMKO**

Slovak University of Technology,  
Faculty of Civil Engineering

Radiant wall systems present a potentially feasible solution for building retrofit which could be preferable to the more common radiant floors and ceilings due to several benefits. The wall systems can be tailored for the specific situation by varying the configuration and thermal properties of the material layers. In this study, we focus on two types of wall cooling systems. The first system has pipes attached to the outer side of the facades of existing buildings. This system was compared with a wall system with pipes embedded underneath the surface in inner plaster. A sample of experimental and computational results is presented to demonstrate the possibilities and limitations of applying these systems in existing buildings. The system with pipes attached to the facades can provide a reasonable thermal output if properly designed. It might be preferable in situations when interventions on the inner side should be avoided. The system with pipes in plaster underneath the surface can be used both on facades and inner walls. Especially when combined with a thermally insulating core made of, e.g., aerated concrete it provides a rapid thermal response and high thermal output and can be very suitable for building retrofit.

Current trends in the design and operation of heating, ventilation and air conditioning include the increasingly frequent use of water-based radiant systems. Installation of such systems can be beneficial due to their suitability for integration with low-grade renewable energy sources such as ground-coupled heat pumps and solar collectors [1,2], comfortable thermal environment [3,4], and relatively high sensible cooling capacity [5]. The

applicability of the individual types of radiant systems depends on their location (floor, wall, or ceiling), the configuration of material layers, and the level of thermal mass.

Although research on radiant surfaces has been mostly focused on structural floors and ceilings, contemporary research suggests that radiant walls also present a potentially feasible solution for space heating and

This research was supported by the Slovak Research and Development Agency under contract No. APVV-16-0126, Ministry of Education, Science, Research and Sport grant 1/0847/18, and by the grant TAČR NCK CAMEB, project Epilot nr. TN01000056/06.



AGENTÚRA  
NA PODPORU  
VÝSKUMU A VÝVOJA



MINISTRY  
OF EDUCATION, SCIENCE,  
RESEARCH AND SPORT  
OF THE SLOVAK REPUBLIC

cooling [6-8]. In a moderate and dry climate and well thermally insulated buildings like, e.g., in Europe, only a fragment of the surface may be needed to create thermal comfort throughout the year [9,10]. This makes radiant walls potentially feasible solution for the retrofit of existing buildings which could be preferable to the more common radiant floors and ceilings due to several potential benefits as discussed in this article.

Nevertheless, scientific studies related to radiant wall systems are relatively scarce. The focus is on new buildings, and the research regarding the use of radiant wall systems in existing buildings as a part of their retrofit is lacking. In this study, we focus on two types of radiant wall cooling systems that could be used in building retrofit. Both systems have pipes attached to the facade, but their configuration of the material layers, thermal performance, and applicability are substantially different. A sample of experimental and computational results is presented to demonstrate the possibilities and limitations of applying these systems in existing buildings.

## Benefits and specifics of radiant wall systems

Radiant walls may provide several advantages over floor and ceiling systems:

- Suitability for building retrofit. Adding a radiant wall does not reduce the story height nor does it induce substantial changes in building structures. On the other hand, installing an additional floor or ceiling system reduces the net story height or requires destructing the existing floor.
- Thermal comfort. In certain cases, wall cooling might reduce the risk of thermal discomfort due to cold floors and air temperature gradients in spaces like residential rooms and cellular offices [4,11-13].
- High thermal capacity and rapid thermal response. Wall systems can provide a fast thermal response and good controllability [8]. The cooling capacity is higher for radiant walls ( $70 \text{ W/m}^2$ ) than floors ( $40 \text{ W/m}^2$ ), though lower than for chilled ceilings ( $100 \text{ W/m}^2$ ). The capacity of heating walls is  $160 \text{ W/m}^2$ , superior to that of radiant floors ( $100 \text{ W/m}^2$ ) and ceilings ( $40 \text{ W/m}^2$ ) [5].
- Several research studies indicate that facades operated as thermal barriers can reduce heat transmission through walls, thus preventing heat losses in winter [14-16] and absorbing external heat gains in summer [17,18].

Radiant walls have certain specifics pertaining to their construction and operation that need to be considered. If installed on the outer side of existing buildings, they are subject to daily and seasonal weather variations. Especially in summer, these variations may be complex because of the fluctuating solar radiation incident on the facade. Compared to floor and ceiling systems, the disadvantage of walls could be the lower angle factor between the occupant and the wall and that interventions need to be done with caution to prevent damaging the pipes.

## Wall cooling with pipes attached to facades

The first technology presented is a wall cooling system constructed according to a patent [19]. The patented design involves pipes arranged in milled channels in thermal insulation, whereby panels are formed. The potential benefit of this system is the possibility to attach the panels to the facades of existing buildings as a part of retrofit with only minor interventions on the interior side of the buildings. The system can be operated both as space cooling in summer and as space heating in winter. Moreover, it could potentially serve as a thermal barrier to reduce transmission heat losses in winter and heat gains in summer [14]. Laboratory measurements were performed for the wall system “as patented” and subsequently an optimization study was carried out to enhance the thermal output.

### Laboratory measurements

The laboratory measurements were conducted on an experimental wall fragment. The fragment consisted of cooling pipes embedded in milled channels in thermal insulation made of polystyrene, attached to the concrete core in the form of a panel. The dimensions of the fragment were  $1140 \text{ mm} \times 1360 \text{ mm}$  (Figure 1). The temperature of the concrete was monitored by PT100 platinum resistance thermometers with the accuracy variable in the range of  $\pm 0.15^\circ\text{C}$ , located at selected points along the panel (points A, B, C, D in Figure 1) at several depths (points 1 to 5 in Figure 1). Supply and return water temperature were also recorded. The heat flux was monitored by a thermopile sensor for studies of the radiative and convective heat flux with a level of accuracy variable in the range  $\pm 5\%$  of the value measured. The sensor was located underneath the surface in the centre of the fragment.

The wall was located between two climate chambers with controlled air temperature and humidity (Figure 2). The fragment was exposed to the air temperature of  $32^\circ\text{C}$  simulating ambient conditions on one side, and

to the air temperature of 26°C simulating the room conditions on the other side. Direct solar radiation was not considered in this study. The temperature of the supply water was kept constant at about 18°C. The heat transfer coefficients between the surface of the wall and each chamber were calculated by a CFD simulation in ANSYS Fluent [20]. A heat transfer coefficient between the wall surface and room of 12.5 W/(m<sup>2</sup>K) was considered representative of the experimental conditions, which is higher than the 8 W/(m<sup>2</sup>.K) as recommended for the design of radiant wall systems [21].

### Design optimization

The temperature and heat flux distribution within the wall fragment were visualized using CalA software developed by one of the authors to solve 2D unsteady heat conduction in building structures [22]. The software has been verified following EN ISO 10211 [23] and EN ISO 11855-2 [21]. The heat transfer analysis was carried out using the Finite Volume Method. The implicit Euler scheme was used for the temporal discretization. The Gauss-Seidel iterative method with successive over-relaxation approach was employed to solve the resulting

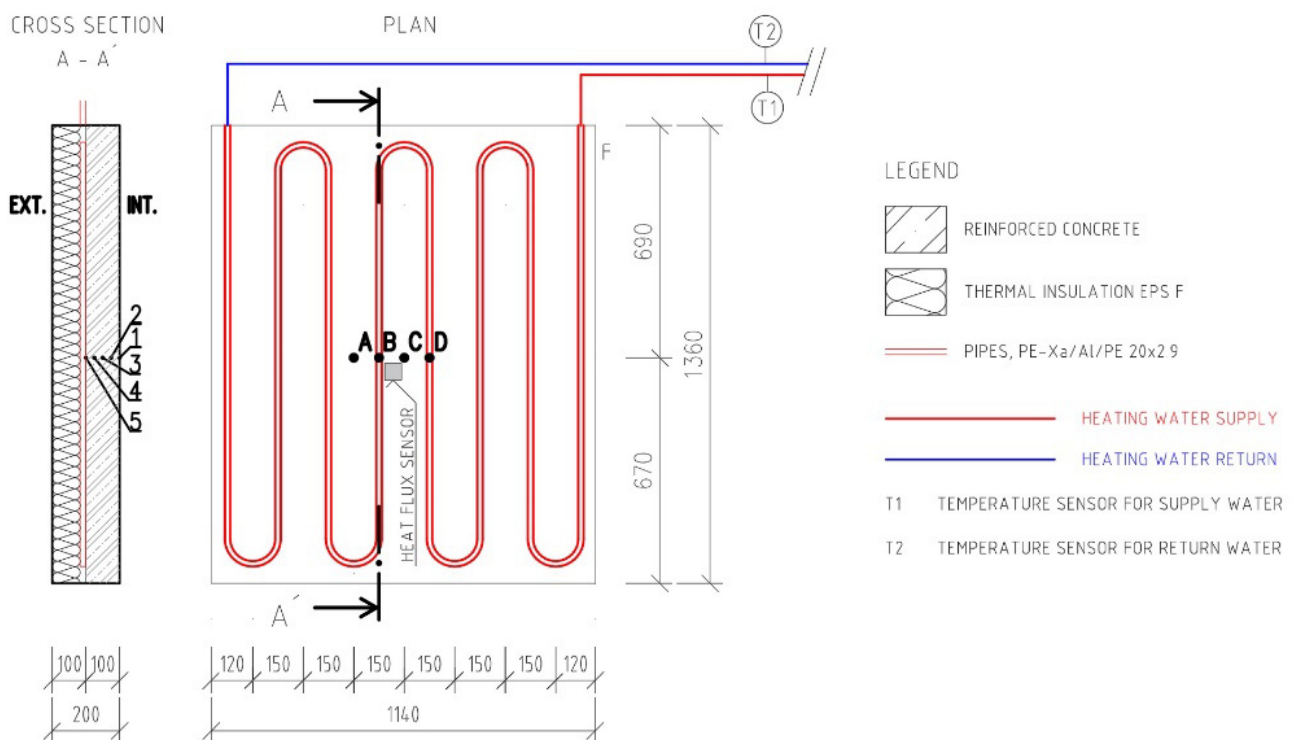

Figure 1. Details of experimental wall and location of sensors [20].

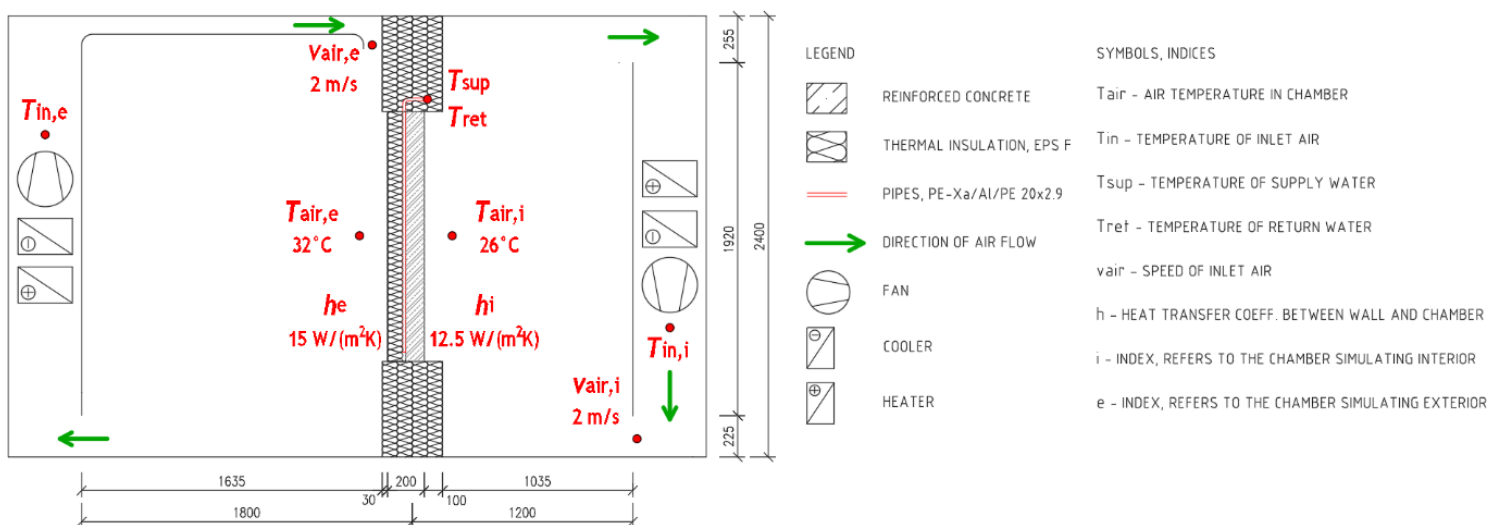

Figure 2. Cross-section of experimental chambers and location of sensors [20].

system of linear equations. The heat transfer coefficient between water and pipe was  $1218 \text{ W}/(\text{m}^2\cdot\text{K})$ . The boundary conditions defining the specific heat flux on the surface of a computational domain were calculated according to Newton's law of cooling, assuming adiabatic boundaries of the wall fragment (Figure 3). The red arrows indicate the direction of the cool transfer. Validation of the computer model by the experiments can be found in Ref. [20]. Figure 4 shows the simulation model as defined in the CalA software.

The simulations and experiments proved that imperfections in the contact between pipe and wall hinder the heat transfer between the pipe and the thermal core. The possibilities to improve the patented design were therefore investigated. The optimization study refers to the room temperature of  $26^\circ\text{C}$  and the mean water temperature of  $21^\circ\text{C}$ . The total heat transfer coefficient ( $h_t$ ) between the radiant surface and space was  $8 \text{ W}/(\text{m}^2\cdot\text{K})$ , and the heat transfer coefficient between water and pipe was  $1218 \text{ W}/(\text{m}^2\cdot\text{K})$ . The combined effect of ambient temperature and solar radiation incident on the wall was approximated by the sol-air temperature ( $T_{\text{sol-air}}$ ) [24] equal to  $57^\circ\text{C}$  which corresponds to the ambient temperature of  $30^\circ\text{C}$  and solar radiation incident on the wall of  $450 \text{ W}/\text{m}^2$ .

The improvements to enhance the cooling output were represented by inserting a metal fin between the pipe and thermally conductive plaster. The purpose of the fin was to efficiently distribute the

cool from the pipe to the thermally conductive plaster. Figure 5 illustrates the difference in the cooling output between a wall fragment without any fin (a) and with a fin with a thickness of 1.56 mm, made of copper (b). Adding the metal fin enhanced the cooling output by about 50% due to the improvement of cool distribution within the wall as shown by the larger dark blue (cool) area between pipe and interior (Figure 5a) and the homogeneous heat flux distribution (Figure 5b).

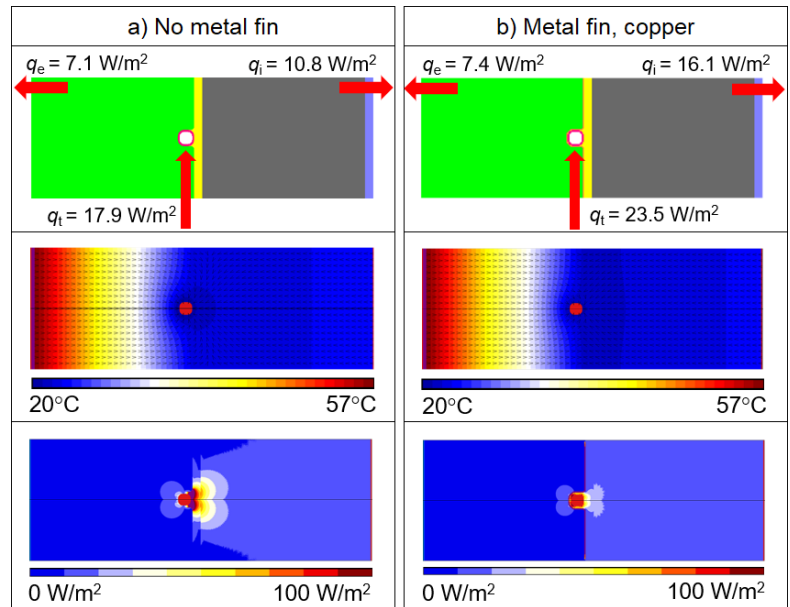

Figure 5. Temperature and heat flux distribution within the wall fragment: a) without metal fin, b) with metal fin made of copper, thickness 1.56 mm, thermal conductivity  $372 \text{ W}/(\text{m}\cdot\text{K})$  [20].

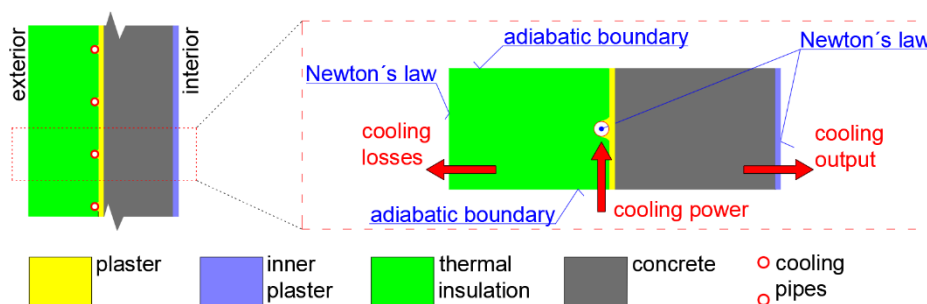

Figure 3. Boundary conditions defining specific heat flux on a wall surface [20].

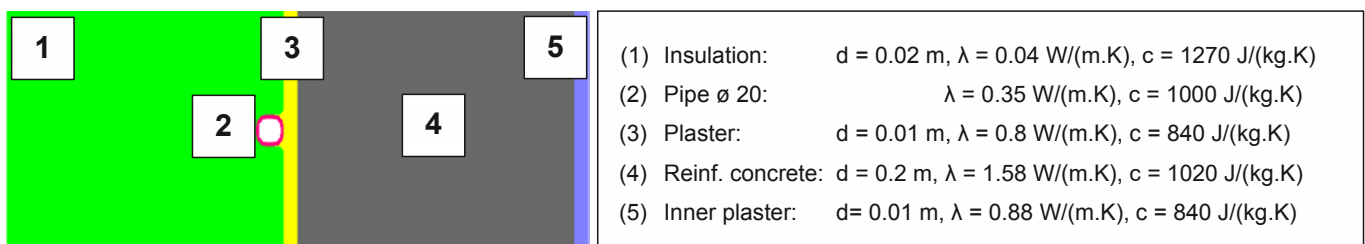

Figure 4. Physical model of the wall fragment as defined in calculation software.

Figure 6 shows the heat flux on the interior side (thermal output) for three materials of the metal fin – copper ( $q_{i\_Cu}$ ), aluminium ( $q_{i\_Al}$ ), and steel ( $q_{i\_steel}$ ). Five cases were considered for the fin made of copper which was most efficient in terms of cool distribution. Three cases were considered for aluminium and steel to allow comparison. The difference between the fins made of aluminium and copper was small regardless of the fin thickness. Increasing the fin thickness had minor effect on the thermal output. Fin made of steel was the least efficient. In this case, the thermal output was most sensitive to the fin thickness.

### Wall cooling with pipes underneath the surface

The wall cooling system with pipes attached to the facade (System A in Figure 7) was compared with a wall system with pipes embedded underneath the surface in plaster (System B in Figure 7). Compared to Section 3, the design of System A was modified so that the cooling pipes were embedded in plaster between thermal core and thermal insulation. System B can be used for building retrofit because the active layer containing the pipes can be easily attached to an existing wall structure.

The results presented in this section were elaborated using the CalA software. The calculation model was based on the validated model described in Section 3 and the properties of the materials were nearly identical. The spacing of the pipes was 150 mm. The overall heat transfer coefficient was  $8 \text{ W}/(\text{m}^2.\text{K})$  on the inner and  $15 \text{ W}/(\text{m}^2.\text{K})$  on the outer wall's surface. The heat transfer coefficient between water and pipe was  $1218 \text{ W}/(\text{m}^2.\text{K})$ . The room temperature and mean water temperature was  $26^\circ\text{C}$  and  $20^\circ\text{C}$ , respectively. The average daily sol-air temperature which combines the effect of ambient temperature and solar radiation incident on the wall was  $41^\circ\text{C}$ . This sol-air temperature is representative e.g. of a southern wall in the temperate climate of Central Europe in July.

### Temperature and heat flux distribution

The temperature and heat flux distribution are visualized in Figure 8 for two materials of thermal core – a thermally insulating aerated concrete and a thermally conductive reinforced concrete. The yellow arrows indicate the general direction of the cool transfer. The thermal output of System A was low because of

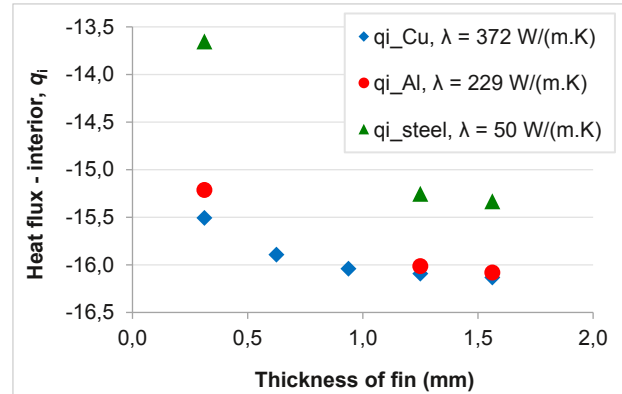

Figure 6. Cooling output of the wall fragment for variable thickness and materials of the fin [20].

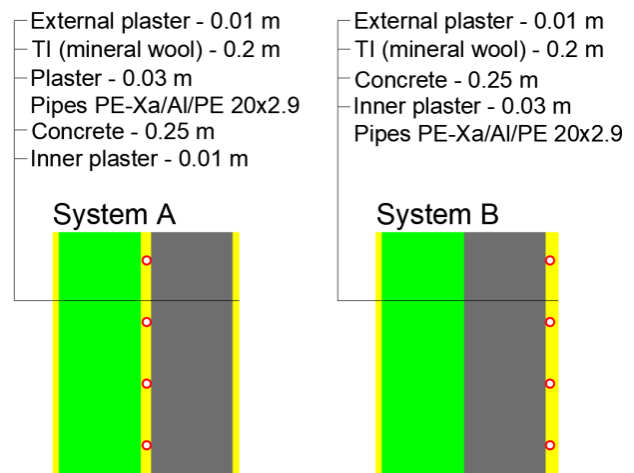

Figure 7. The two wall cooling systems studied.

| System (outer wall) | Aerated concrete, $\lambda = 0.19 \text{ W}/(\text{m}.\text{K})$ |           | Reinforced concrete, $\lambda = 1.58 \text{ W}/(\text{m}.\text{K})$ |           |
|---------------------|--|-----------|---|-----------|
|                     | Temperature  | Heat flux | Temperature   | Heat flux |
| A                   |  |           |   |           |
| B                   |  |           |   |           |

Figure 8. Temperature and heat flux distribution for the cooling systems located on an external wall [8].

the cooling losses and the cool being accumulated in the concrete core. As expected, this system makes sense only with thermally conductive core, otherwise, the thermal output is too low.

For System B, both aerated and reinforced concrete are meaningful, but the core material has a substantial effect on the heat transfer. With aerated concrete, the cool is directed to the interior, whereas with reinforced concrete the cool is distributed in the structure more evenly which leads to more cool being stored. System B with aerated concrete can be therefore efficient even without any insulation on the outer side of the wall. The maximum thermal output was higher in the case of reinforced concrete because the cool was distributed more evenly in the structure which resulted in more homogeneous surface temperature and consequently higher output.

### Thermal response

The effect of core material on the thermal response of the systems was observed as well. Thermal response of radiant systems significantly affects their controllability, operating strategy, and overall applicability. In the tests, the cooling system was powered on at 9:00 and turned off at 17:00 o'clock. A control strategy was devised where the thermal output was kept between 63% ( $q_{63}$ ) and 90% ( $q_{90}$ ) of its maximum value by turning the cooling system on and off. Although simplified as compared to real operating conditions, this control strategy permits evaluating thermal response and controllability of the wall systems [8].

The response of System A was always slow due to the thermal coupling of the pipes and the thermal core, and the distance of the pipes from the interior. Figure 9

shows that concrete properties are crucial for the thermal dynamics of System B. The combination with reinforced concrete resulted in a slow thermal response. On the contrary, the aerated concrete acted as thermal insulation and directed the cool to the interior causing a faster thermal response.

### Conclusion

Radiant wall systems can be readily installed in existing buildings as a part of their retrofit. The various combinations of thermal properties and configuration of the material layers allow tailoring the wall system for the specific situation. The suitability of a specific wall cooling solution depends on the requirements such as avoiding interventions in the interior, exploiting thermal storage, ensuring high thermal output, or providing a fast thermal response.

Two representatives of the wall systems potentially suitable for building retrofit were presented. It was shown that System A with the pipes attached to the outer side of a facade can provide a reasonable thermal output if properly designed (adding metal fin between pipe and core or embedding the pipes in thermally conductive plaster). Though this system has a substantially lower thermal output than System B, it might be preferable in situations when interventions on the inner side of the wall should be avoided.

System B with pipes embedded in plaster underneath the surface can be used both on facades and inner walls. If the wall's thermal core is made of an insulating material such as, e.g., aerated concrete, no thermal insulation may be needed on the outer side of the wall. Thermal

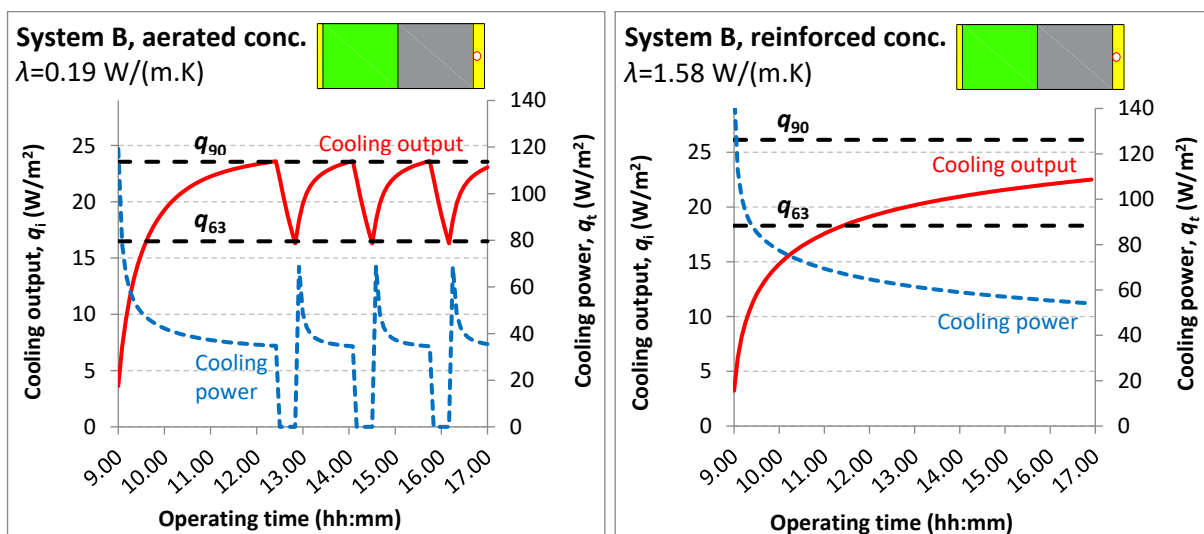

Figure 9. Effect of core material on thermal response of System B [8].



losses of such a wall system are low, it has a rapid thermal response and high thermal output which makes it suitable for installation in both new and existing buildings.

In case of a thermally conductive core, similar system characteristics can be achieved by adding a layer of thermal insulation between pipes and the core. ■

## References

- [1] Romani J, Belusko M, Alemu A, et al. Control concepts of a radiant wall working as thermal energy storage for peak load shifting of a heat pump coupled to a PV array. *Renew Energ* 2018; 118:489–501.
- [2] Wang X, Zheng M, Zhang W, et al. Experimental study of a solar-assisted ground-coupled heat pump system with solar seasonal thermal storage in severe cold areas. *Energy Build* 2010; 42:2104–2110.
- [3] Wu X, Fang L, Olesen BW, et al. Comparison of indoor air distribution and thermal environment for different combinations of radiant heating systems with mechanical ventilation systems. *Building Serv Eng Res Technol* 2018; 39(1):81–97.
- [4] Tomasi R, Krajčák M, Simone A, et al. Experimental evaluation of air distribution in mechanically ventilated residential rooms: Thermal comfort and ventilation effectiveness. *Energy Build* 2013; 60:28–37.
- [5] Babiak J, Olesen BW, Petráš D. *Low temperature heating and high temperature cooling*. Rehva Guidebook No 7. 3rd revised ed. Brussels, Belgium: Rehva (2013).
- [6] Karabay H, Arici M, Sandik M. A numerical investigation of fluid flow and heat transfer inside a room for floor heating and wall heating systems. *Energy Build* 2013; 67:471–478.
- [7] Bojić M, Cvetković D, Marjanović V, et al. Performances of low temperature radiant heating systems. *Energy Build* 2013; 61:233–238.
- [8] Krajčák M and Šikula O. The possibilities and limitations of using radiant wall cooling in new and retrofitted existing buildings. *Appl Therm Eng* 2020; 164:114490.
- [9] Harmati N, Folić RJ, Magyar ZF, et al. Building envelope influence on the annual energy performance in office buildings. *Therm Sci* 2016; 20:679–693.
- [10] Directive 2010/31/EU of the European Parliament and of the Council of 19 May 2010 on the energy performance of buildings.
- [11] Le Dréau J and Heiselberg P. Sensitivity analysis of the thermal performance of radiant and convective terminals for cooling buildings. *Energy Build* 2014; 82:482–491.
- [12] Krajčák M, Tomasi R, Simone A, et al. Thermal comfort and ventilation effectiveness in an office room with radiant floor cooling and displacement ventilation. *Sci Technol Built En* 2016; 22(3):317–327.
- [13] Kim T, Kato S, Murakami S, et al. Study on indoor thermal environment of office space controlled by cooling panel system using field measurement and the numerical simulation. *Build Environ* 2005; 40:301–310.
- [14] Šimko M, Krajčák M, Šikula O, et al. Insulation panels for active control of heat transfer in walls operated as space heating or as a thermal barrier: Numerical simulations and experiments. *Energy Build* 2018; 158:135–146.
- [15] Ljubenović M, Mitković P, Stojanović B, et al. Intelligent skin and occupancy in the context of increasing energy efficiency in buildings. *Annals of Faculty Engineering Hunedoara – International Journal of Engineering* 2018; 26(3):201–207.
- [16] Krzaczek M and Kowalczyk Z. Thermal Barrier as a technique of indirect heating and cooling for residential buildings. *Energy Build* 2011; 43:823–837.
- [17] Zhu Q, Li A, Xie J, et al. Experimental validation of a semi-dynamic simplified model of active pipe-embedded building envelope. *Int J Therm Sci* 2016; 108:70–80.
- [18] Xie J, Zhu Q and Xu X. An active pipe-embedded building envelope for utilizing low-grade energy sources. *J Cent South Univ* 2012; 19:1663–1667.
- [19] Kalús D, Páleš P and Pelachová L. *Self-supporting heat insulating panel for the systems with active regulation of heat transition*. Patent WO/2011/146024, 2011.
- [20] Šimko M, Krajčák M and Šikula O. Radiant wall cooling with pipes arranged in insulation panels attached to facades of existing buildings. *E3S Web of Conferences* 2019; 111:03013.
- [21] EN ISO 11855-2:2012. Building environment design - Design, dimensioning, installation and control of embedded radiant heating and cooling systems - Part 2: Determination of the design heating and cooling capacity.
- [22] Šikula O. *Software CALA User Manual (In Czech)*. Brno, Czech Republic: Tribun (2011).
- [23] EN ISO 10211:2018. Thermal bridges in building construction. Heat flows and surface temperatures. Detailed calculations.
- [24] ASHRAE. *ASHRAE Handbook – Fundamentals*. Atlanta, GA, USA: American Society of Heating, Refrigerating, and Air Conditioning Engineers (2017).

# Optimal Indoor Air Parameters in Historical Buildings: Determination Technique



**IURII A. TABUNSHCHIKOV**

Doctor of Engineering, Professor at the Moscow Architecture Institute (State Academy), President of ABOK



**MARIANNA BRODACH**

Candidate of Engineering, Professor at Moscow Institute of Architecture (State Academy), Vice President of ABOK



**NIKOLAI SHILKIN**

Candidate of Engineering, Professor at Moscow Institute of Architecture (State Academy)

Analysis of the literature sources dedicated to studies of historical buildings, including museum and churches, has shown that the most disputed question in monitoring of historical buildings is “optimal indoor air parameters” that must ensure long-term preservation of the works of art [1-9].

**Keywords:** museum, historic building, church, indoor air temperature, humidity, microclimate, optimal indoor air parameters, permissible indoor air parameters

We will introduce the term “historic building” – meaning a church, museum or church-museum building, including the items indoor of it, that has architectural and/or historical-artistic value. The problem with defining “optimal indoor air parameters” is relevant for historic as well as numerous modern museum buildings. Curators of almost every museum have their own strong conviction in this matter that “is not a subject to criticism and discussion”. As a result, the reference literature contains numerous “tables” recommending the “optimal indoor air parameters” that often differ from each other significantly. Most of the researchers recommend the following range of parameters for historic buildings, including museum and church buildings, equipped with an air conditioning system: indoor air temperature 16–22°C and indoor air humidity 45–55% [1–3].

It is assumed that the reasons for such situation lies in the lack of a scientifically justified technique for determination of the “optimal indoor air parameters” that should ensure long-term preservation of historic buildings. It is also assumed that these values depend on numerous factors: building age, type of exhibited items, climate control system, indoor temperature and humidity conditions, building operation mode, climatic conditions at the building’s location, etc.

According to ABOK standard “Russian Churches and Cathedrals. Heating, Ventilation, Air Conditioning” the terms “optimal indoor air parameters” and “permissible indoor air parameters”, if you ignore the parts related to people, have the following definition: **optimal indoor air parameters** do not cause moisture or temperature related deformations that have a negative impact on

the long-term preservation of easel paintings, art paintings, decorative finish and objects of worship practices with historical and cultural value; **permissible indoor air parameters** do not cause moisture or temperature related deformations leading to fast deterioration of easel paintings, art paintings, decorative finish and objects of worship practices with historical and cultural value.

A special case is unheated museum and church buildings; the known reference literature does not have any definition of the “optimal and permissible indoor air parameters” for them and, thus, does not offer any numerical values for them.

Let's give a definition for the term: **permissible indoor air parameters in unheated church-museum purpose temples** – upper and lower limits of indoor air temperature and humidity range that does result in systematic occurrence of significant humidity and temperature related deformations leading to fast irreparable deterioration of wall fresco paintings, wooden iconostasis, icons and other church ornaments with historical and cultural value.

Therefore, from the definitions given above it follows that determination of the optimal and permissible indoor air parameters is related to determination of the minimum deformation values that ensure long-term

preservation of art objects. Here we will present the basic provisions of the technique of determination of the optimal indoor air parameters of historic buildings based on the studies of deformation properties of art objects.

Each museum, church or museum-church building, when considered as a single complex from the perspective of the temperature and humidity conditions analysis, consists of a building envelope and various exhibition items: paintings, sculptures, interior decorations, or for churches: icons, fresco paintings, wooden iconostasis, churchware. All of the historic building components listed above have one common characteristic: they are capillary-porous objects containing moisture.



Interior of the Cathedral of the Dormition.



Interior of the Sistine chapel. "The Last Judgment" by Michelangelo.

Table 1 and Table 2 [10] present typical values of porosity and normal moisture content of some construction materials.

In the process of building operation with indoor air temperature and humidity fluctuations the indoor surfaces of building envelope, as well as exhibition objects with historical and artistic value indoor the building take up moisture from air in the form of vapors. This process is called sorption.

Relation between material moisture content by mass\* and relative humidity of air is plotted as sorption isotherms. Sorption isotherms for wood (Figure 1) and brick (Figure 2) show that material moisture content by mass increases as the relative humidity of air goes up [10].

We will refer to brick and wood, the sorption indicators of which are shown above, as the new construction materials as opposed to “old construction materials” in the building envelope constructions, icons and wooden iconostasis, the age of which can reach several centuries. It was determined that sorption, and thus deformation characteristics of old construction materials and things made of them significantly differ from similar new construction materials and things made of them [11].

Studies of the temperature and humidity conditions and thermophysical properties of envelope constructions of the Moscow Kremlin Cathedrals during construction of air conditioning systems have identified the following specifics of sorption properties of old construction materials used in envelope constructions [11]:

- sorption curves of brick samples taken from the walls of the Assumption and the Archangel Cathedrals (old construction materials) have higher equilibrium moisture content than similar modern materials. Thus, the maximum hygroscopic moisture content (i.e. moisture content corresponding to full saturation of air at the given temperature) of red brick taken from the walls of cathedrals of the Moscow Kremlin is 9–18%. This parameter for modern red brick, including brick used for restoration works in the Moscow Kremlin, does not exceed 1–1,8%. Higher sorption capacity is obviously caused by significant contents of minerals in the construction materials that were in operation for several centuries. To verify

\* Material moisture content by mass  $w_B$ , % is determined by ratio of moisture mass in the material sample to the dry sample weight.

Table 1. Common porosity values of some typical construction materials.

| Material  | Density, kg/m <sup>3</sup> | Porosity, % |
|-----------|----------------------------|-------------|
| Red brick | 2100                       | 20          |
| Oak       | 700                        | 58          |
| Pine      | 500                        | 65          |
| Birch     | 600                        | 57          |
| Aspen     | 400                        | 75          |

Table 2. Normal values of materials moisture content in building envelope constructions.

| Material                 | Density, kg/m <sup>3</sup> | Material moisture content, % |            |
|--------------------------|----------------------------|------------------------------|------------|
|                          |                            | by weight                    | volumetric |
| Red brick in solid walls | 1800                       | 1.5                          | 2.7        |
| Lime-sand plaster        | 1600                       | 1                            | 1.6        |
| Wood (pine)              | 500                        | 15                           | 7.5        |

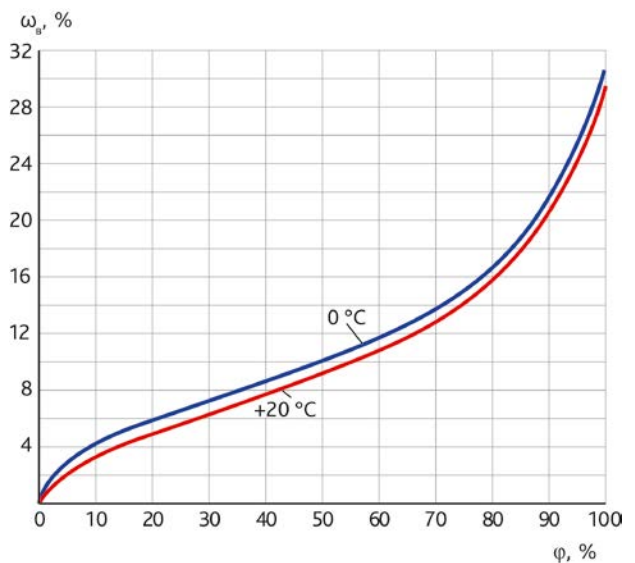

Figure 1. Water vapor sorption isotherm for wood.

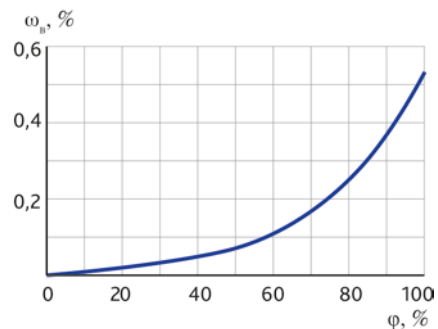
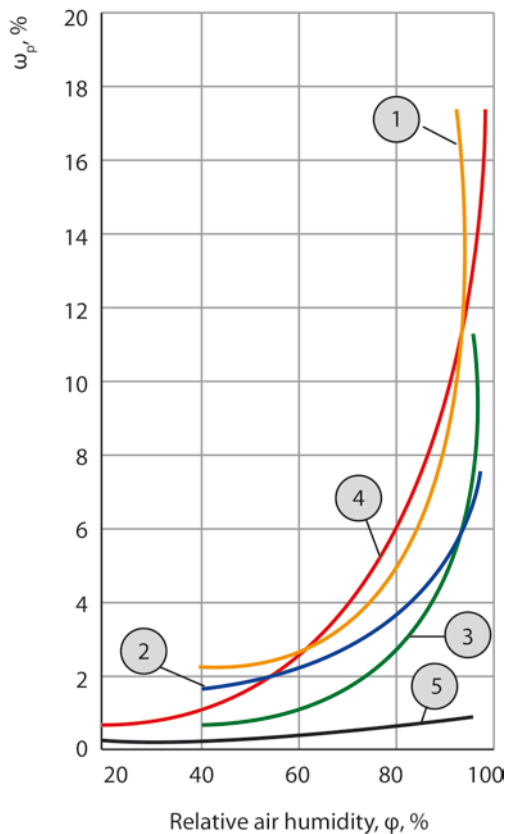

Figure 2. Water vapor sorption isotherm for regular brick.

this assumption the researches have determined the sorption properties of samples of bricks specially produced for restoration of envelope constructions of Kremlin cathedrals that were previously saturated with  $\text{Na}_2\text{SO}_4$  and  $\text{MgSO}_4$  salts. Sorption properties of the materials taken from cathedral walls and materials that were subjected to artificial salinization were quite similar, as seen in Figure 3.



**Figure 3.** Sorption isotherms for red brick samples.

1, 2, 3 = samples taken from cathedral walls;  
4 = sample of restoration material artificially salinized with mixture of  $\text{Na}_2\text{SO}_4$  and  $\text{MgSO}_4$ ;  
5 = restoration non-salinized material sample.

The following circumstance should be noted. Since “old construction materials” contain salts accumulated over extended period of their operation, i.e. are “salinized”, the dew point temperature on the inner surface of envelope constructions will be higher compared to the dew point temperature of structures made of “new construction materials”.

Graphs of relative deformation of plaster samples taken from the walls of the Assumption Cathedral and Museum are presented in Figure 4. Relative deformation is the ratio of change in the linear dimension of a sample  $\Delta l$  in mm to its linear dimension in absolutely dry air ( $\varphi = 0\%$ ). From Figure 4 it is seen that the biggest increase in the relative deformation of this material is observed in the relative air humidity variation range from 60 to 90% in the process of sorption humidification. During moisture desorption from plaster samples, i.e. during material drying loss, the situation is somewhat different: in the relative air humidity variation range from 40 to 90% the magnitude of relative deformation changes insignificantly, while in the relative air humidity variation range from 20 to 40%, we observe significant changes in the relative deformation. It was also determined that graphs of relative deformation of limestone have similar but not as prominent nature. Also, it was determined, and this is very important, that moisture related deformations are multiple time higher than temperature related deformations of plaster and limestone samples.

Therefore, the reason for deterioration of long-term preservation of museum and church exhibitions, as well as fresco paintings, is moisture and temperature related deformation of the materials of exhibitions and fresco paintings.

So, the objective of ensuring long-term preservation of the works of art is to determine and maintain such

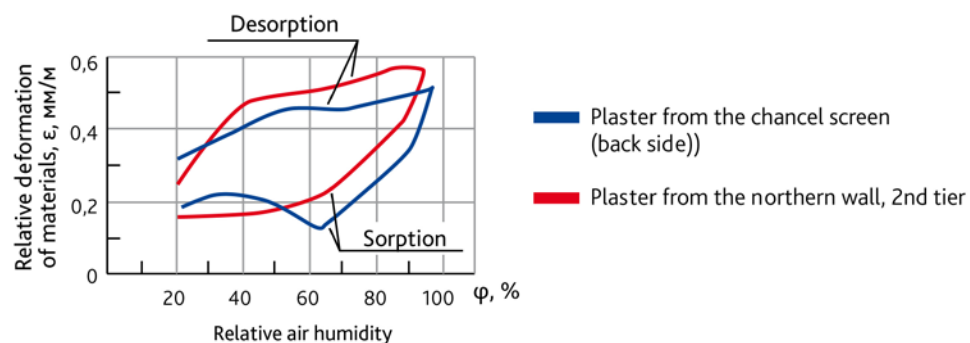

**Figure 4.** Graphs of relative deformation of plaster material from the walls of the Assumption Cathedral.



Cathedral of the Dormition (Uspensky sobor) in Moscow.

parameters of indoor air during operation that will prevent deformation or keep it within permissible limits.

If a building is equipped with an air conditioning system than, according to **Figure 4**, it would be possible to recommend maintaining relative humidity of indoor air in 40–55% range. However, this result is only preliminary: to make a final decision on the range of relative humidity variations we need to analyse deformation indicators of samples of other materials from the historical building that have architectural or historical-artistic value.

If a historic building is equipped with an air conditioning system, it will be possible to maintain the humidity condition of indoor air at the required level. The humidity conditions of indoor air in a heated building equipped with an air conditioning system are directly linked to the humidity of outside air due to natural or forced ventilation air exchange. In the summer period outside air has high moisture content (**Table 3**) and, as it freely enters the building interior the moisture is absorbed by internal surfaces of envelope constructions, iconostasis and icons, while in the winter period the outside air has significantly lower moisture content, i.e. is practically dry, so when the building is heated the difference between partial pressure of vapor in humid

air and on the internal surface of building envelope or surfaces of objects with historical-artistic value drives the intensive drying process. **Table 3** presents approximate value of moisture content of outside air in g/kg during summer (June–August) and winter (December–February) periods for the following cities: Moscow, Saint Petersburg, Yaroslavl, Rostov-on-Don.

Saturation of a “dry” capillary-porous object with moisture during summer leads to the so called swelling process, i.e. increase in the object size, which in turn is responsible for occurrence of deformations, called moisture related deformations; if the magnitude of deformation is significant, it can result in destruction of the material structure. Evaporation of moisture from “wet” capillary-porous object in winter leads to the

**Table 3.** Approximate value of moisture content of outside air in g/kg during summer and winter periods of the year.

| Year period | Moisture content of outside air in g/kg for cities |                  |           |               |
|-------------|--|------------------|-----------|---------------|
|             | Moscow   | Saint Petersburg | Yaroslavl | Rostov-on-Don |
| Winter      | 1.1  | 1.5              | 1.1       | 1.3           |
| Summer      | 10   | 9.5              | 10        | 10.5          |

reverse process called “drying shrinkage”; if the process is intensive or extensive, it also causes deformations and can result in destruction of the structure of material or objects made of it. Similar phenomena take place when the material temperature changes.

Therefore, if a building is only equipped with a heating and ventilation system, regular “swelling” in summer and “drying shrinkage” in winter will lead to alternating deformation resulting in deterioration of long-term preservation of historic buildings and objects of historical-artistic value located inside of them.

## Conclusions

1. Optimal or permissible indoor air parameters for historic buildings including church and museum-church buildings should be determined on the basis of analysis of changes in the sorption and deformation properties of the materials of inner surface of the building envelope and materials of the works of art.
2. It is expected that the optimal indoor air parameters will differ for every individual historic building or may be identical for some of them, and will depend on a number of factors, including the building age, nature of exhibition items, specifics of the building use conditions, climate control system, etc.

The information presented above allows to recommend the following step-by-step technique of determining the optimal indoor air temperature parameters for historic buildings.

- Take samples of the materials of exhibits from historic buildings, and materials of inner surfaces of the building envelope constructions. Considering the artistic value of the exhibits, the samples should be of the minimum size required for analysis.
- Determine the sorption indicators of material samples using, for example, the methods from GOST 24816–14 “International Standard. Building Materials. Method of equilibrium hygroscopic moisture determination” as guidelines.
- Study the deformation indicators of materials using, for examples, methods and equipment described in [2] or other more modern methods or equipment as guidelines.
- Perform comparative analysis of the deformation and sorption graphs of the material samples and select their values which only result in insignificant changes in indicators when they vary. This values will determine the optimal values of the indoor air temperature for a historic building. ■

## References

- [1] Camuffo D. Microclimate for Cultural Heritage. Developments in Atmospheric Science, 23, Elsevier, 1998, 420 p.
- [2] Camuffo D., Bernardi A. The Microclimate of the Sistine Chapel, Rome BOLLETTINO GEOFISICO. Anno 18, Numero 2, Aprile–Giugno, January, 1995, p. 7–33.
- [3] Negroa E., Cardinale T., Cardinale N., Rospi G. Italian guidelines for energy performance of cultural heritage and historical buildings: the case study of the Sassi of Matera. European Geosciences Union General Assembly 2016, EGU Division Energy, Resources & Environment, ERE. Energy Procedia 97 (2016), p. 7–14.
- [4] Popper R., Niemz P., Croptier S. Adsorption and desorption measurements on selected exotic wood species analysis with the Hailwood – Horrobin model to describe the sorption hysteresis. WOOD RESEARCH 54 (4):200943–56.
- [5] Camuffo D., Bertolin C., Fassina V. Microclimate monitoring in a Church. Environmental chapter 3. Environment 01/06/10 10.24 Pagina 43.
- [6] Vasilyev G.P., Lichman V.A., Peskov N.V., Brodach M.M., Tabunshchikov Y.A., Kolesova M.V. Simulation of heat and moisture transfer in a multiplex structure, Energy and Buildings 86 (2015), p. 803–807.
- [7] Cardinale T., Rospi G., Cardinale N. The influence of indoor microclimate on thermal comfort and conservation of artworks: the case study of the Cathedral of Matera (South Italy). Energy Procedia 59 (2014), p. 425–432.
- [8] Brodach Marianna Heating of Cathedrals - Alternative practices // ABOK. – 2004. – No. 2.
- [9] Sizov B.T. Thermophysical Aspects of Preservation of Architecture Landmarks // ABOK. – 2002. – No. 1. pp. 24–31.
- [10] Fokin K.F. Construction Heat Engineering of Building Envelopes. M.: ABOK-PRESS, 2006
- [11] Tabunshchikov Iurii. A. Dahno V.N., Melnikova I. S., Protsenko V.N. Thermal Conditions in Architecture Monuments (using cathedrals-museum of the Moscow Kremlin as an examples: compil. “Building Thermal Physics (Microclimate and Thermal Insulation of Buildings”). M.: NIISF, 1979.

# Impact of groundwater quality on heat pump operation



**MILAN MITRIĆ**

MSC

“Solar”, Pancevo, Serbia

solarpancevo@gmail.rs

It is not enough to determine the abundance and depth of the well as a source, but it is also necessary to perform a chemical water analysis at the project design stage in order to avoid possible exploitation problems. It is a misconception that only mechanical groundwater impurities can affect the operation of a heat pump; even greater problems are caused by bacteria that may appear in the environment of increased concentrations of some chemical elements. How to find a solution? This paper is based on practical example.

**Key words:** groundwater, heat pumps performance, chemical analysis, bacteria impact

The application of heat pumps in the field of heating and cooling of residential and business buildings in the Republic of Serbia has become significant. The use of renewable energy sources is a global trend and also an international obligation to reduce the use of conventional, depleted, energy sources and preserve a cleaner living environment. In this paper, the emphasis will be placed on the thermal use of groundwater as a renewable energy resource.

## Legal regulation

There is no legal regulation for the use of air and earth as energy resources in the Republic of Serbia, while the Ministry of Energy once issued instructions and recommendations for the use of groundwater, which in practice were at the level of legal regulations. The

given recommendations were very rigorous and complicated, as if the settlement was supplied with drinking water, not taking into account that groundwater is used exclusively as technical water, which is returned to nature in the same amount, without changing the chemical composition and with a slight temperature change allowed.

Certainly, in the near future, the rules and procedures for the use of all forms of renewable energy sources must be clearly and realistically defined through legislation in order to avoid problems in practice, so that all users of renewable energy sources should be registered and the Republic of Serbia will reach the prescribed percentage of renewable energy sources. in total energy consumption, prescribed by the European Union Directive 2018/2001[4]



## Case study

In the current practice when using water-to-water heat pumps, the main focus was on the secondary part of the air conditioning installation and the heat pump itself as a device: proper calculation of energy needs, proper sizing of equipment and access to groundwater as an energy resource was superficial, based on experience of others or pre-letting someone else to solve. The only criteria for excavating the well was the natural static groundwater level, the depth of the well and the dynamic level of groundwater during exploitation (well yield).

Many papers have been published on the impact of groundwater quality on heat pump operation and capacity [6], the impact of heat pump operation on the environment, the impact of chemical composition and groundwater temperature on heat pump operation [5], but only few papers have focused on the impact of bacteria on optimal heat pump operation and on the environment [2] which in practice can arise as a major problem.

Some basic facts have been neglected: that in general the waters in the Republic of Serbia are slightly alkaline and hard and that precipitation and air temperature have the greatest impact on groundwater recharge and quality, especially on free-level and shallow horizons, where water was mostly used. The chemical composition of groundwater has been completely neglected and it turned out that it is very important in the correct determination of the location and other parameters of the well. **Figure 1** shows the characteristic profiles of well in the vicinity of Pecinci, and **Figure 2** shows well in Pancevo.

The picture shows all aquifers potentially suitable for exploitation, but the exploitation of groundwater is carried out from three horizons: 56–61.5 m, 67–76 m and 82–84.5 m due to the water quality where the suction screens are placed. The purpose of this well with a diameter of Ø450 mm is for irrigating seedlings with technical water by pumping with a submersible pump and free outflow of water through a perforated pipe network. The achieved water flow is 12 l/s, with a depression of 4.5 m.

It can be seen that groundwater is exploited from two horizons: 30–40.5 m and 48.5–57.5 m, where suction screens are installed. The purpose of this well with a diameter of Ø323 mm is to supply the heat pump of the water-water system with technical water by pumping with two cascaded submersible pumps

placed each on one exploitation horizon and pouring water into an open channel for collecting and draining groundwater and atmospheric water. The achieved water flow is 7 l/s.

It is noticeable that in both wells, which are located on the territory of Vojvodina, the layers below 40 m have approximately the same composition, while in the upper layers the composition looks different due to surface influences and microclimate (precipitation, aeolian sediments, soil leaching, etc.). There were no problems during the exploitation of the well in Pecinci because the submersible pump freely discharged water into the irrigation system, while during the exploitation of the well in Pancevo for the purpose of supplying the heat pump, serious problems appeared.

## System description

For the needs of hot and cold water production used in the air conditioning system in the building, a heat pump of the water-water system with a heating capacity of 142 kW with four cascaded compressors is provided. A detachable lamellar heat exchanger is installed to protect the heat pump. For pumping groundwater, two submersible pumps were installed in a cascade, at the depths of groundwater exploitation. The pumps are switched on depending on the required flow, i.e. the engaged capacity of the heat pump.

During the exploitation, a reddish colour of groundwater was noticed, which carried with it a certain dense mass resembling mud (**Figure 3**). This mass was deposited in the pre-exchanger, reducing the flow to such an extent that the compressors were switched off one by one until the moment of cessation of operation. The pre-exchanger was disassembled and cleaned every 10 days, which caused a delay in the operation of the air conditioning system, costs and, in the end, the nonsense of installing such a system.

In some other, smaller facilities, an identical situation occurred: the heat pump heat exchanger was clogged, the pre-filter was changed every 7 days, and the submersible pump itself was covered with a reddish mass resembling mud that absolutely prevented groundwater suction and shutdown. system. By rinsing the heat exchanger with chemical agents, replacing the filter and removing and cleaning the submersible pump, the problems were solved for a short time, and some of them gave up the use of the heat pump.

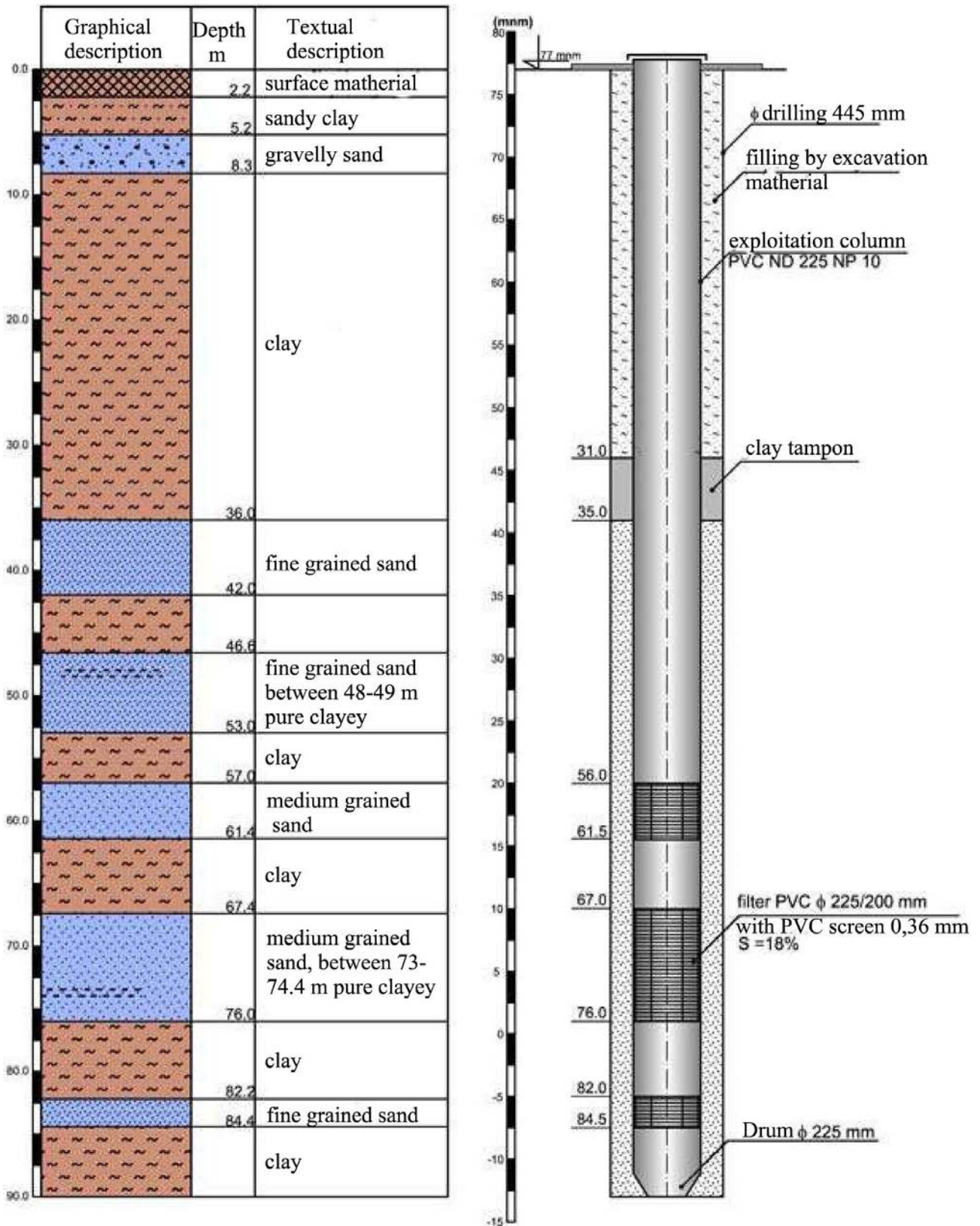

Figure 1. Vertical profile of a well in the vicinity of Pecinci.

### Laboratory analyses

It has long been thought that “red mud” is the result of some mechanical impurities, siltation of wells or some kind of oxidation. However, laboratory testing of groundwater samples and analysis of the results led to a completely different finding. Namely, “red mud” are nothing but a type of anaerobic bacteria, called, ferro bacteria, which live in the depths, in waters rich in iron and feed on iron! Ferro bacteria usually manifest as brown, red or white sticky, slimy substances suspended in water. They are harmless to health but dangerous to installations. By pumping groundwater with pumps, these bacteria are also captured, and by transporting such water through pipelines, they are deposited on the walls, fittings and flow meters. The problem is that they can be optionally anaerobic, i.e. they can live and reproduce in environments with and without the presence of air.



Figure 3. Appearance of the pre-exchanger.

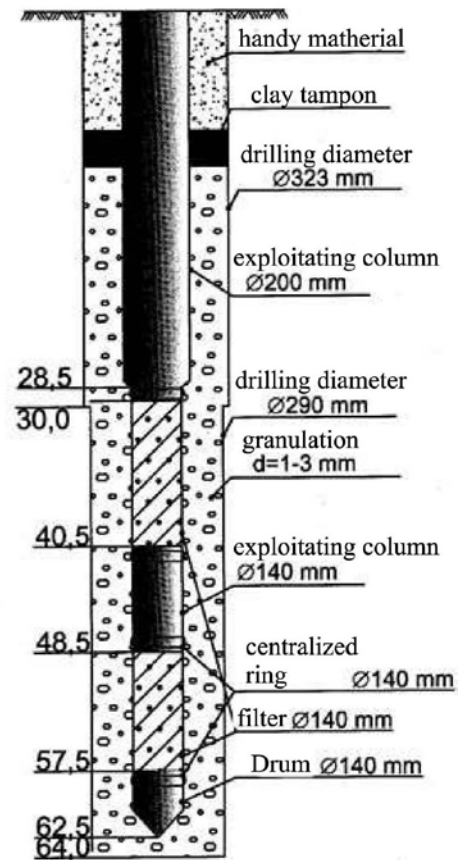
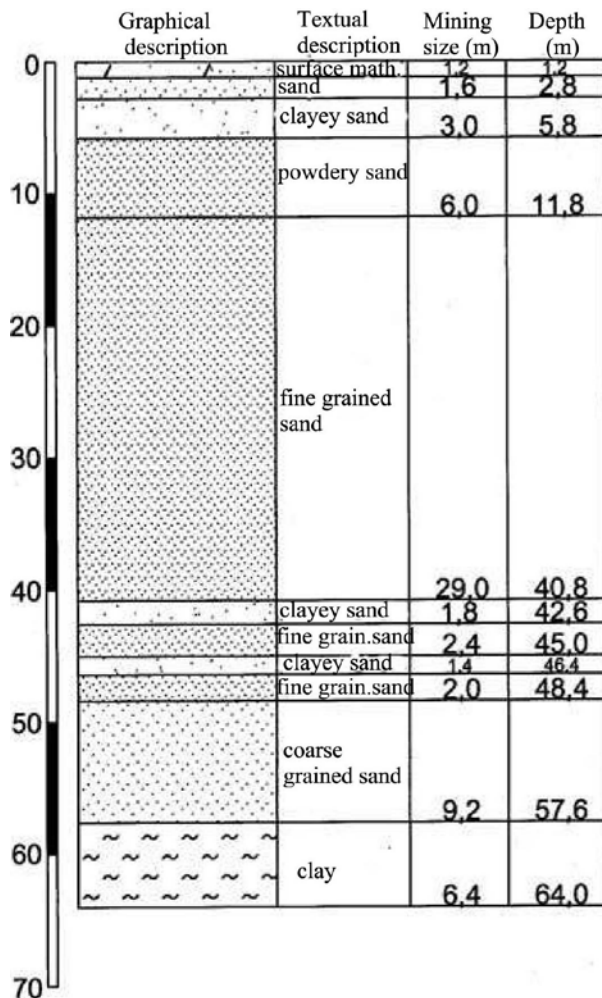

Figure 2. Vertical profile of a well in Pancevo.

Groundwater characteristics at the global level are:

- Waters from the first issue (depth up to about 18 m) are usually rich in calcium and magnesium salts, ie they are waters of increased total hardness, with a slightly increased content of ammonia, iron and manganese, as well as low concentrations of sodium
- Groundwater of the second released (depth up to about 80 m) is softer with higher concentrations of ammonia, iron and manganese, slightly increased content of arsenic and chloride, as well as low concentrations of sodium
- The waters of the third edition, which have been trapped in underground reservoirs for tens of thousands of years, are extremely soft, with an increased content of sodium, ammonia, arsenic and orthophosphate. Definitely during the passage of water on the way from the first to the third issue a natural softening process takes place on zeolite materials

**Table 1** shows the maximum permitted concentrations of metals, non-metals, cations, anions and other water pollutants in different water categories. In addition to the total hardness, calcium content, special attention should be paid to the content of iron (Fe) in water because the increased concentration of iron is a suitable substrate for the appearance of anaerobic bacteria that can cause serious problems in heat pumps of water-water systems.

In this paper, we will focus only on the iron content in groundwater. From the table we can see that for the needs of water supply (technical water) the maximum allowed concentration of iron is 0.3 mg/l. If this concentration is higher than the maximum allowed, the presence of anaerobic bacteria can be expected, which can cause problems in the operation of the heat pump. That is why the laboratory analysis of groundwater is very important for the correct selection of the location and depth of the well, i.e. the level from which the groundwater will be exploited.

*Table 1. Maximum permitted concentrations of elements in water.*

| Classification                            | Technical water<br>MPC | Bottled water<br>MPC | Natural mineral<br>MPC | Spring water<br>MPC |
|---|------------------------|----------------------|------------------------|---------------------|
| <b>1. Basic physical-chemical values</b>  |                        |                      |                        |                     |
| Temperature (°C)                          |                        |                      |                        |                     |
| pH value                                  | 6.8–8.5                | 6.8–8.5              |                        | 6.5–9.5             |
| Turbidity (NTU)                           | 1                      | 0,6                  |                        |                     |
| Colour (Pt-Co scale degree)               | 5                      | 10                   |                        |                     |
| Electrolytic conductivity (mS/cm)         | 1000                   | 500                  |                        | 2500                |
| Dry residue (mg/l on 180°C)               | -                      | 500                  |                        |                     |
| Total hardness of water                   | 6.6                    |                      |                        |                     |
| Consumption KMnO <sub>4</sub> (mg/l)      | 8                      | 5                    |                        |                     |
| <b>2. Dissolved gases</b>                 |                        |                      |                        |                     |
| Oxygen                                    | -                      |                      |                        |                     |
| Carbon dioxide (CO <sub>2</sub> ) (mg/l)  | -                      |                      | 250*                   |                     |
| Hydrogen Sulphide H <sub>2</sub> S (mg/l) | without                | without              |                        |                     |
| <b>3. Macro components</b>                |                        |                      |                        |                     |
| Cations                                   | mg/l                   | mg/l                 | mg/l                   | mg/l                |
| Calcium (Ca)                              | 200                    | 100                  | 150*                   |                     |
| Magnesium (Mg)                            | 50                     | 30                   | 50*                    |                     |
| Sodium (Na)                               | 150                    | 20                   | 200                    | 200                 |
| Potassium (K)                             | 12                     | 10                   |                        |                     |
| Anions                                    | mg/l                   | mg/l                 | mg/l                   | mg/l                |
| Hydro carbonate (HCO <sub>3</sub> )       |                        |                      | 600*                   |                     |
| Chlorides (Cl)                            | 200                    | 25                   | 200*                   | 250                 |
| Sulphates (SO <sub>4</sub> )              | 250                    | 25                   | 200*                   | 250                 |
| Nitrates (NO <sub>3</sub> )               | 50                     | 5                    | 50                     | 50                  |

**4. Micro components**

| Metals                          | mg/ℓ                | mg/ℓ            | mg/ℓ      | mg/ℓ                 |
|---------------------------------|---------------------|-----------------|-----------|----------------------|
| Iron (Fe)                       | 0.3                 | 0.05            | 1*        | 0.2                  |
| Mangan (Mn)                     | 0.05                | 0.02            | 0.5       | 0.05                 |
| Chrome total (Cr II)            | 0.05                | 0.05            | 0.05      | 0.05                 |
| Chrome total (Cr II)            | 0.05                | 0.10            | 0.05      | 0.05                 |
| Aluminium (Al)                  | 0.2                 | 0.05            |           | 0.2                  |
| Barium (Ba)                     |                     | 0.1             | 1         |                      |
| Zinc (Zn)                       | 3.0                 | 0,1             |           |                      |
| Cooper (Cu)                     | 2.0                 | 0.1             | 1         | 0.002                |
| Lead (Pb)                       | 0,01                | 0.05            | 0.01      | 0.01                 |
| Cadmium (Cd)                    | 0.003               | 0.005           | 0.003     | 0.003                |
| Arsenic (As)                    | 0.010               | 0.05            | 0.010 tot | 0.01                 |
| Antimony                        |                     |                 | 0.0050    | 0.0050               |
| Selenium (Se)                   |                     | 0.01            | 0.01      | 0.01                 |
| Quicksilver (Hg)                | 0.001               | 0.001           | 0.0010    | 0.001                |
| Nickel (Ni)                     |                     | 0.01            | 0.020     | 0.02                 |
| Non-metals                      | mg/ℓ                | mg/ℓ            | mg/ℓ      | mg/ℓ                 |
| Ammonium ion (NH <sub>4</sub> ) | 0.1 NH <sub>3</sub> | 0.01-           |           | 0.50 NH <sub>3</sub> |
| NitritesfNOT)                   | 0.03                |                 | 0.1       | 0.0001               |
| Phosphor (P)                    |                     | 0.03-phosphates |           |                      |
| Borates (BO <sub>3</sub> )      |                     | 1.0-borates     | -         | 0.001                |
| Fluorides (F)                   | 1.2                 | 1.0             | 1*        | 0.0015               |
| Bromides (Br)                   | -                   |                 |           |                      |

**5. Radioactivity**

| Parameter - Activity | Bq/ℓ | Bq/ℓ | Bq/ℓ | Bq/ℓ |
|----------------------|------|------|------|------|
| Total α - activity   |      | 0.1  |      |      |
| Total β - activity   |      | 1,0  |      |      |
| 226 Ra               |      |      |      |      |

**6. Pollutants**

| Parameter                  | mg/ℓ  | mg/ℓ |      |      |
|----------------------------|-------|------|------|------|
| Cyanides                   | 0.050 |      | 0.07 | 0.05 |
| Total Phenol               | 0.001 |      |      |      |
| Detergents                 | 0.1   |      |      |      |
| Total Grease and oils      | 0.100 |      |      |      |
| Organo-chlorine pesticides | 0.5   |      |      |      |
| PAH                        |       |      |      |      |

**7. Microbiology**

|  | Presence | Presence | Presence | Presence |
|--|----------|----------|----------|----------|
| Aerobic mesophilic bacteria in 1 mℓ          | 100      |          | 20       |          |
| Coliform bacteria of faecal origin in 100 mℓ | 0        |          |          |          |
| Total coliform bacteria in 100 mℓ            | 0        |          |          |          |
| Streptococci group D in 100 mℓ               | negative |          | 0        |          |
| Proteus species in 100 mℓ                    | negative |          |          |          |
| Sulphite-reducing clostridia in 100 mℓ       | 1        |          | 0        |          |
| Pseudomonas aeruginosa in 100 mℓ             | negative |          | 0        |          |

**Table 2** shows the results of laboratory analysis of raw groundwater from wells in Pancevo [3]. It is visible that the increased concentration of iron is significantly above the MDK and the fact is that “red mud” – anaerobic bacteria – appear in that water. The analysis does not include anaerobic ferro bacteria because the Laboratory is not equipped for that type of analysis, but there are Laboratories that do that as well. Ferro bacteria are not harmful to human health but only reflect the degree of purity of the water.

Thus, the analysis showed that natural well, unfiltered and untreated water from the subject site has a significantly increased concentration of iron (3.9 mg/ℓ) and manganese (0.15 mg/ℓ) and the water hardness is 27.2°dH. The presence of chloride is significantly below the MDK, 32.1 mg/ℓ, and mesophilic aerobic bacteria 83 CFU/mL. It is reasonable to assume that anaerobic ferro bacteria can appear in water of this composition.

### Problem solution

After the cause of the “red mud” that clogged the heat pre-exchanger was determined, the method of destroying such bacteria by chlorination was started. A time chlorination system was installed on the suction pipeline of the well water in front of the heat pre-exchanger by injecting 12.5% sodium hypochlorite solution directly into the pipeline. The mentioned solution is normally used for disinfection of drinking water and pool water.

The result was unexpectedly good: more than a year passed without the need for cleaning and rinsing the

pre-exchanger, and during that time the heat pump itself functioned properly and without problems.

Submersible drainage sump pumps were not removed from the wells because they were functioning properly. But in some other facilities of smaller capacity, the submersible pump was completely covered with “red mud” and did not give any flow. This can be caused by the amount of anaerobic bacteria in the environment of the pump suction basket or the suction power of the pump – in a facility with a water flow of about 2 m<sup>3</sup>/h the well pump was surrounded by “red mud” while in the facility with a water flow of about 25 m<sup>3</sup>/h for now there were no such problems.

Since the well water was discharged into an open drainage channel, the laboratory analysis was started again to determine the concentration of residual chlorine (Cl) in the water and to see whether the water pollutes the earth and the environment and whether there has been a change in chemical water composition. The results are shown in **Table 3**. [3].

Repeated analysis of groundwater after chemical treatment by chlorination shows that the water got a more natural colour, that it is significantly clear, that a smaller drop in chloride and a drastic drop in the concentration of aerobic mesophilic bacteria were recorded. The observed decrease in the concentration of iron and manganese is not a consequence of water chlorination, but by natural process. The concentration of residual chlorine is below the permitted limit, the water is bacteriologically correct, so as such this water does not pollute the earth or the environment.

**Table 2.** Laboratory analysis of raw groundwater in Pancevo [3].

| Parameter                     | Unit   | Limiting value | Reference method          | Result    |
|-------------------------------|--------|----------------|---------------------------|-----------|
| Temperature                   | °C     |                | Guide book P-IV-1         | 21,5      |
| Colour                        | Pt-Co  | 5              | SRPS ENISO 7887 2013      | 82,7      |
| Odour                         | /      | without        | HDMI-002                  | backwater |
| Turbidity                     | NTU    | 5              | HDMI-003                  | 30,5      |
| Iron                          | mg/L   | 0,3            | HDMI-017                  | 3,9       |
| pH                            | /      | 6,8-8,5        | HDMI-007                  | 7,2       |
| Consumption KMnO <sub>4</sub> | mg/L   | 12             | HDMI-009                  | 6,3       |
| Residue evaporation           | mg/L   | -              | HDMI-012                  | 515       |
| Electrical conductivity       | µS/cm  | 2500           | HDMI-011                  | 859       |
| Ammonia                       | mg/L   | 1              | HDMI-029                  | 0,39      |
| Chlorides                     | mg/L   | 250            | SRPS ISO 9297:1997        | 32,1      |
| Nitrites                      | mg/L   | 0,03           | HDMI-004                  | <0,006    |
| Nitrates                      | mg/L   | 50             | HDMI-005                  | 1,2       |
| Manganese                     | mg/L   | 0,05           | HDMI-018                  | 0,15      |
| Hardness of water             | °dH    | -              | Rule book III/15          | 27,2      |
| Aerobic mesophilic bacteria   | CFU/mL | 100            | SRPS ENISO 6222:2010/37°C | 83        |

**Table 3.** Laboratory analysis of chlorinated groundwater in Pancevo [3].

| Parameter                     | Unit   | Limiting value | Reference method          | Result  |
|-------------------------------|--------|----------------|---------------------------|---------|
| Temperature                   | °C     | -              | Guide book P-IV-1         | 22,5    |
| Colour                        | Pt-Co  | 5              | SRPS ENISO 7887 2013      | 8,5     |
| Odour                         | /      | without        | HDMI-002                  | without |
| Turbidity                     | NTU    | 5              | HDMI-003                  | 0,9     |
| Iron                          | mg/L   | 0,3            | HDMI-017                  | 1       |
| pH                            | /      | 6,8-8,5        | HDMI-007                  | 7,4     |
| Consumption KMnO <sub>4</sub> | mg/L   | 12             | HDMI-009                  | 4,6     |
| Residue evaporation           | mg/L   | -              | HDMI-012                  | 415     |
| Electrical conductivity       | µS/cm  | 2500           | HDMI-011                  | 961     |
| Ammonia                       | mg/L   | 1              | HDMI-029                  | 0,27    |
| Chlorides                     | mg/L   | 250            | SRPS ISO 9297:1997        | 19,2    |
| Nitrites                      | mg/L   | 0,03           | HDMI-004                  | <0,006  |
| Nitrates                      | mg/L   | 50             | HDMI-005                  | 2,2     |
| Manganese                     | mg/L   | 0,05           | HDMI-018                  | 0,08    |
| Hardness of water             | °dH    | -              | Rule book III/15          | 27,2    |
| Aerobic mesophilic Bacteria   | CFU/mL | 100            | SRPS ENISO 6222:2010/37°C | <1      |
| Water temperature             | °C     | -              | DMI-003                   | 15,1    |
| Air temperature               | °C     | -              | DMI-003                   | 24,9    |
| Residual chlorine             | mg/L   | up to 0,5      | DMI-004                   | 0,2     |

## Conclusion

1. “Red mud” that occurs during the exploitation of groundwater in water-water heat pump systems are anaerobic ferro bacteria that feed on iron in water.
2. Effective destruction of ferro bacteria as well as other bacteria is by chlorination of water by injecting 12.5% sodium hypochlorite solution directly into the feed pipeline. Controlled and measured chlorine injection does not endanger the earth or the environment into which the water is discharged.
3. The suction power of the well pump, ie the speed and flow of well water, are important for preventing the deposition of bacteria on the suction basket and preventing clogging of the pump itself.
4. Chlorination of groundwater significantly prolongs the period of need for regular cleaning of heat pre-exchangers or heat pump heat exchangers
5. It is necessary to perform test excavation of wells and laboratory analysis of groundwater from the exploitation level in the phase of design and selection of energy production systems in order to determine the yield of wells and the presence of iron (Fe) in the water.
6. Increased concentration of iron in water is not a condition for the obligatory appearance of anaerobic ferro bacteria, but it is a significant indicator that it will most likely happen.
7. Well maintenance and repairs are generally a very important prerequisite for optimal heat pump operation [1] [7]. ■

## References

- [1] Mike Deed: *Groundwater Management in Geothermal Systems*, GSHPA, London.
- [2] Heejung Kim, Jin-Yong Lee: *Effects of a groundwater Heat pump on thermophilic Bacteria Activity*, Water, 2019.
- [3] Institute of Public Health, Pancevo, Serbia: *Water test Reports V6042 and V6215*, 2019.
- [4] Directive (EU) 2018/2001 of the European Parliament and of the Council of 11. December 2018 on the promotion of the use of energy from renewable sources (recast).
- [5] García-Gil, A.; Epting, J.; Garrido, E.; Vázquez-Suñé, E.; Lázaro, J.M.; Sánchez Navarro, J.Á.; Huggenberger, P.; Calvo, M.Á.M. *A city scale study on the effects of intensive groundwater heat pump systems on heavy metal contents in groundwater*. *Sci. Total Environ.* 2016, 572, 1047–1058. [CrossRef]
- [6] Bucci, A.; Prevot, A.B.; Buoso, S.; De Luca, D.A.; Lasagna, M.; Malandrino, M.; Maurino, V. *Impacts of borehole heat exchangers (BHEs) on groundwater quality: The role of heat-carrier fluid and borehole grouting*. *Environ. Earth Sci.* 2018, 77, 175.
- [7] Houben, G.; Treskatis, C. *Water Well Rehabilitation and Reconstruction*; McGraw-Hill: New York, NY, USA, 2007.

# The application of sorption rotors in the air drying technology



## ALEKSANDAR PJEVIĆ

Company: Lindab Group  
Main project engineer  
The member of KGH –  
Serbian HVAC&R Society  
aleksandar.pjevic@lindab.com

All types of buildings are for dehumidification systems largely driven by concerns over energy usage, indoor air quality and the operational effectiveness of program types that handle hygroscopic materials. Therefore, the ability to maintain strict humidity levels within a desired range by removing moisture from supply air is a critical aspect of air conditioning system design.

**Keywords:** air dehumidification; the application of sorption rotors; LCC analysis; condensation method of drying

## Typical buildings that need air dehumidification

The main problems that occur in the case of increased humidity above certain level in buildings of various purposes are the next:

- development of mold and bacteria
- condensation on all structures
- corrosion
- feeling of stuffy and uncomfortable air
- forming of frost or ice on heat exchangers.

Just because of that, different buildings and facilities presented in Table 1, require air drying treatment in order to avoid the indicated consequences :

*Table 1. Building types and humidity problems.*

| # | Buildings that require moisture removal          | Consequences   |
|---|--|--|
| 1 | Pharmacy - production of hygroscopic medicaments | a) Medicaments cannot be used  |
| 2 | Ice halls and hockey arenas                      | a) Deterioration of ice quality<br>b) Increasing of the ice thickness<br>c) Condensation of water vapor  |
| 3 | Facilities with swimming pools                   | a) Destruction of the building structure and external walls, corrosion on metal surfaces<br>b) Bad climatic conditions for living and strong smell of chlorine |
| 4 | Food industry, raw material warehouses           | a) Formation of places with intensive growth of fungi and bacteria, issues of the microbiological situation<br>b) Corrosion                                    |
| 5 | Beer production                                  | a) Growth of bacteria and microorganisms<br>b) Low quality products  |



### Different methods of air drying

**Condensation method.** The essence of the method is based on the principle of water vapor condensation, contained in the air, when it is cooled below the dew point.

The executive mechanism of the process is a heat pump with a freon contour, whose elements, the evaporator and the condenser, are located one after the other (Figure 1).

**Moisture adsorption.** Adsorption is the separation of a substance from a gaseous medium or solution by means of a surface layer of a liquid or solid. (Figure 2).

Thanks to the porous capillary structure of the adsorbent, it very efficiently draws water vapor out of the air, but if it is saturated with moisture, the efficiency drops drastically.

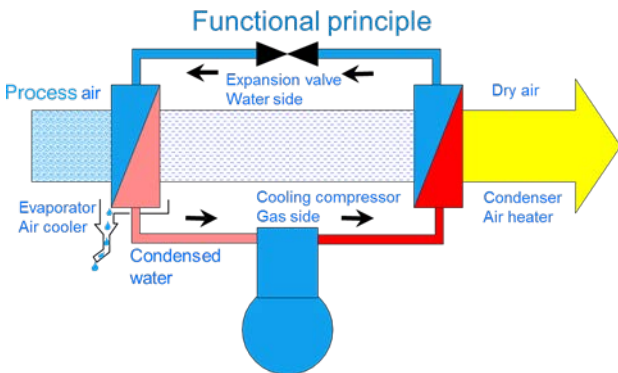

Figure 1. Functional diagram of the condensation method.

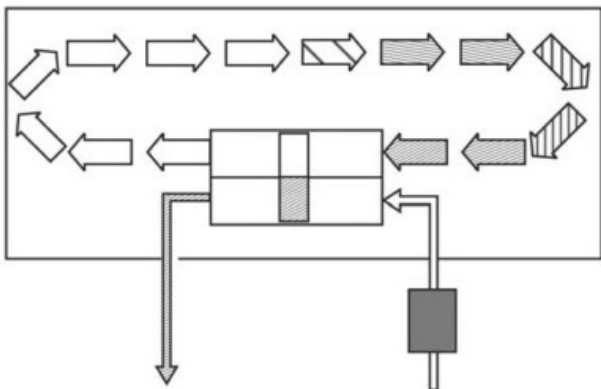

Figure 2. Scheme of sorption method of air drying.

In order to achieve a continuous process, the adsorbent must be periodically regenerated, i.e. it is necessary to eliminate the accumulated moisture by blowing hot air. In accordance with the above, the change and decrease in relative humidity can be illustrated by means of H-x diagrams (Figure 3):

- air heating
- cooling and then heating the air
- sorption air dehumidification

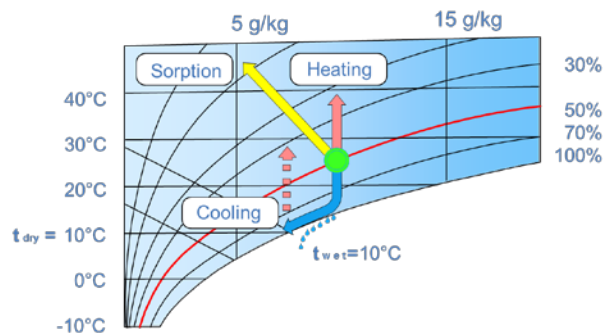

Figure 3. Changes in the condition of the air in the H-x diagram leading to a decrease of relative humidity.

### Comparative analysis of different air drying methods

**Sorption method against condensation.** If we generally compare two conceptually different, and, in any case, realistic methods, dehumidification by cooling is functional in the case of small changes in moisture content in the air, because the difficulties in operation are necessarily manifested by freezing frost and ice on the heat exchanger – cooler with temperatures below 0°C, as soon as the task of removing a larger amount of moisture occurs.

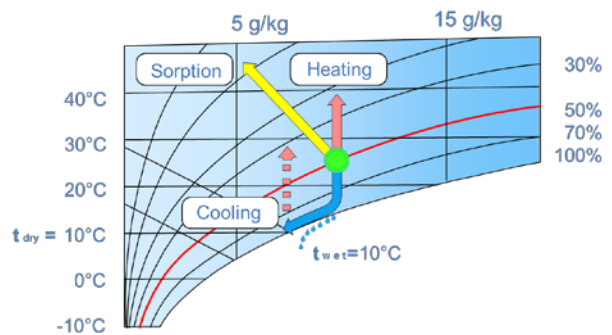

Figure 4. Comparison of different air drying methods in the H-x diagram,

On the other hand, sorption dehumidifiers function normally in the case of the elimination a large amount of moisture from the air, and they require a smaller amount of air than the condensation method to remove the same amount of moisture.

**Real application of different methods in practice.** The dehumidifier with integral freon contour works better in high humidity conditions, where there is no risk of ice freezing on the freon evaporator, especially for swimming pools.

Sorption humidifier works well in both dry and humid environments, but is more expensive to invest in and operate than condensation-type air drying in humid environments.

**Different variants of the air drying sorption method.** The RECUSORB principle (Figure 6) implies integrated heat recovery in the part of the sorption rotor, as a result of which the energy costs of rotor regeneration are reduced, and the dried air is drier and cooler compared to other sorption drying methods. It is characteristic for climates with moderately humid climate.

The CONSORB principle (Figure 7) is primarily used in very humid climates, where it shows more significant efficiency compared to RECUSORB.

**Life cycle costs LCC of different air drying methods**

**Sorption method compared to condensation.** The LCC calculation performed in this paper is based on the recommendations of the Eurovent certification system and the provisions of important standards in this area VDI 2067-1 and DIN V 18599-3.

In the HVAC technique, there are rough estimates of the operating costs of air conditioning units (Figure 8), but for accurate conclusions about expected costs it is necessary to calculate the LCC life cycle costs.

As a rule, the calculation takes place in accordance with the climatic conditions of the facility on which the equipment is planned to be installed and the period of its operation.

The behaviour of the building in the climatic sense is simulated by different scenarios which primarily depend on the parameters of the outside air. The following influential variables, such as energy prices, investment and maintenance costs, complete the base for the calculation.

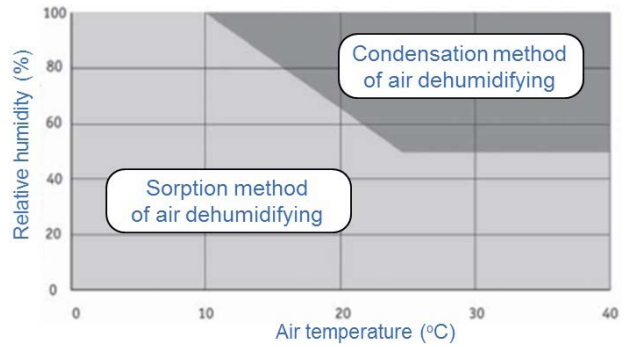

Figure 5. Areas of two methods application depending on the drying air parameters.

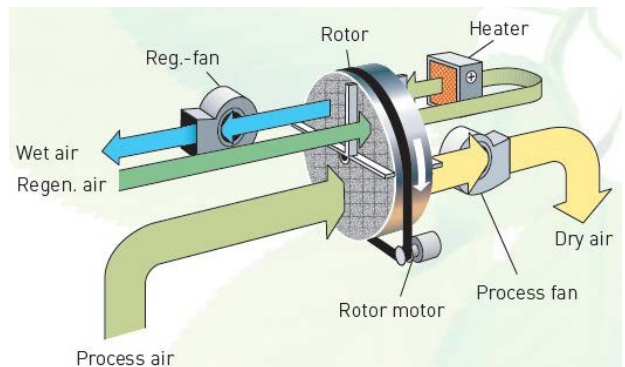

Figure 6. Schematic overview of the sorption drying method RECUSORB.

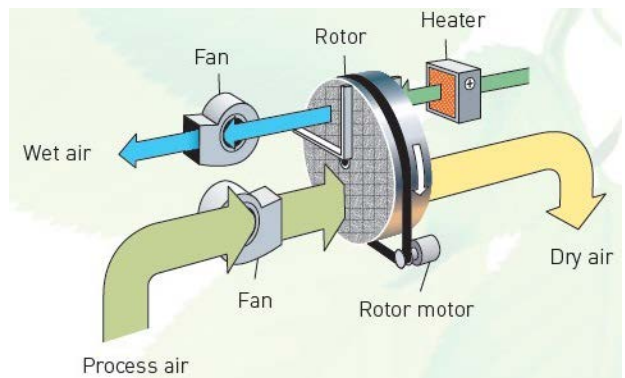

Figure 7. Schematic overview of the sorption drying method CONSORB.

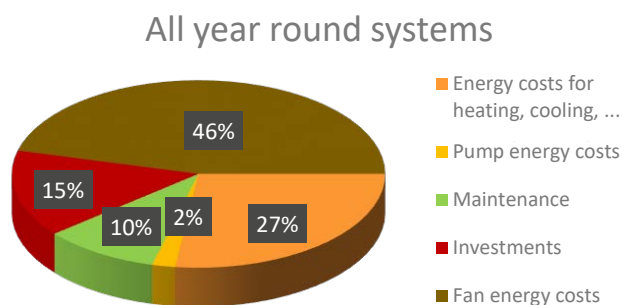

Figure 8. The share of various factors in the total cost of the equipment operating.

**Concept of sorption method for air drying.** The AHU for process air in hygienic design (Figure 9) is equipped with a mixing section with the aim of recirculating 50% of air from the room, filter section, sorption rotor, water heater, freon evaporator, compressor, fan, silencer and second stage filter. Part of the unit are sections for rotor regeneration using room air, filter, with electric heater and fan.

A ventilation unit for air extraction and recirculation has been designed separately. An obligatory element in this concept is the remote freon condenser, and the correctly chosen rotor is most responsible for the functionality and dehumidification of the air (Figure 10).

Tandem compressors ZR94 + ZRD94 (Figure 11), one of which is digital, due to precise automatic regulation, together with the evaporator and remote condenser, cool the heated air after the rotor with a slight deviation from the desired parameters of the incoming air.

**Concept of condensation method for air drying.** It was designed the two-stage AHU with mixing section, air heater, glycol cooler with the specific temperature regime of propylene glycol  $-3 / -8^{\circ}\text{C}$ , electric heater, fan, silencer and a second-stage filter (Figure 12).

The specificity of this unit is the need for cooling and drying the air to a temperature of  $0^{\circ}\text{C}$ , as a result of which there is the formation of frost and ice on the exchanger, which must be eliminated due to functionality by means of electric heaters built into the fins. This need also requires the use of a non-standard chiller which has the ability to cool a mixture of water and glycol to a regime of  $-3 / -8^{\circ}\text{C}$ .

### General conditions for the equipment selection of both systems

A detailed overview of costs for 15 years operation time period is presented in the Annex of online version of this article.

### Conclusion

The presented LCC analysis compares, from the technical-economic aspect, two realistic methods for dehumidification of air in space, sorption and condensation.

The method for dehumidification with by means of a sorption rotor is characterized by significantly higher investment costs, but during operation it has a distinct advantage in reduced consumption of electricity and

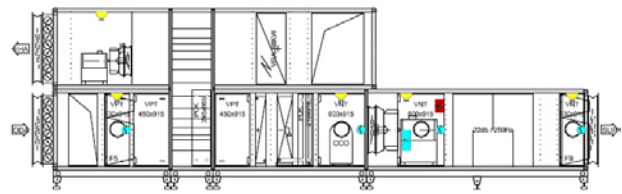

Figure 9. The drawing of Air Handling Unit for process air treatment.

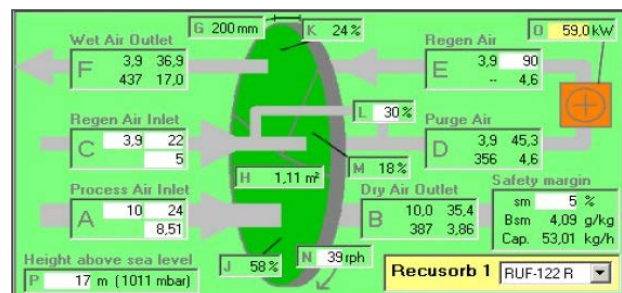

Figure 10. Technical characteristics of the sorption rotor.



Figure 11. Cooling circuit with tandem compressors in the AHU.

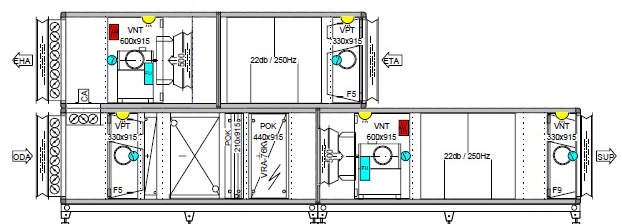

Figure 12. Drawing of AHU for air drying by condensation method.

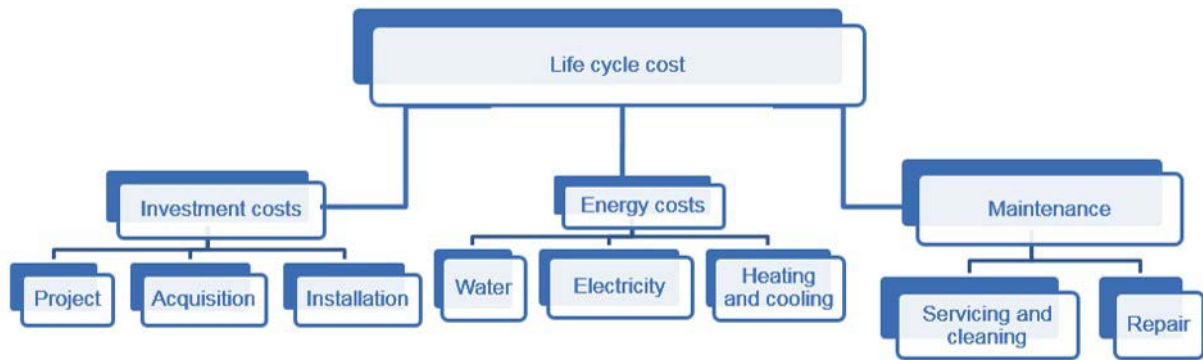
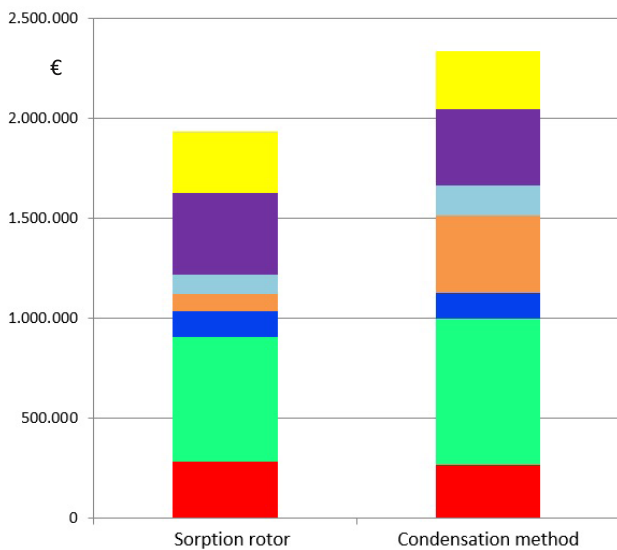

Figure 13. Components considered in the LCC calculation.

cooling energy, to the extent that the investment pays off after 8 months from the start of operation.

The LCC analysis calculation has been done for a pharmaceutical plant in close environment of Moscow, Russia, the main input data were presented in Table 2 and comparative chart for both system on Figure 14. ■

Results of LCC analysis



- Costs maintenance/operating
- Costs capital
- Costs for CO<sub>2</sub> emission
- Costs of cooling energy
- Costs of heat energy
- Costs of electricity
- Investment costs

Figure 14. Comparative chart of LCC costs.

Table 2. Input data for LCC analysis (Location: Moscow, Russian Federation).

|   |                              |
|---|------------------------------|
| Review period                                 | 15 years                     |
| Period of operation time                      | 15 years                     |
| Annual interest rate                          | 5%                           |
| Annual service and maintenance costs          | 6%                           |
| Annual system operation time                  | 8760 hours, without stopping |
| Supply airflow                                | 10.000 m <sup>3</sup> /h     |
| Exhaust airflow                               | 10.000 m <sup>3</sup> /h     |
| Room temperature                              | 22°C                         |
| Relative humidity all year round no more than | 30%                          |
| Outdoor air parameters in Moscow              |                              |
| Winter  | T = -25°C, φ = 83%           |
| Summer  | T = 26°C, φ = 55,9%          |
| Energy costs in Moscow                        |                              |
| Electricity                                   | 0,11 €/kWh                   |
| Heating                                       | 0,03 €/kWh                   |
| Cooling                                       | 0,05 €/kWh                   |
| Emission CO <sub>2</sub>                      | 0,017 €/kg                   |
| Price change factors                          |                              |
| Investment/service/operation                  | 3%                           |
| Energy consumption                            | 4%                           |

References

- [1] Branislav Todorović, *Klimatizacija*, SMEITS, Beograd, 1998.
- [2] DST-SG, *catalogues and brochures of sorption rotor producer*.
- [3] VDI 2067-1, *Economic efficiency of building installations. Fundamentals and economic calculation*, 2010.
- [4] DIN V 18599-3, *Energy efficiency of buildings – Energy need for air conditioning*, 2007.
- [5] Chapter 22 of the ASHRAE Handbook-Fundamentals – Desiccant dehumidification.
- [6] Сотников А.Г., *Процессы, аппараты и системы кондиционирования воздуха и вентиляции - Том 1*, Sankt-Peterburg 2005.

# Air-Conditioning of the Laboratory for Testing of Samples for the Coronavirus Called “Fiery Eye”



**DEJANA SOLDO**

M.Sc.M.E.  
Sokolnžinžering,  
Serbia, [www.sokoing.rs](http://www.sokoing.rs)  
[dejana.soldo@sokoing.rs](mailto:dejana.soldo@sokoing.rs)

## Introduction

A laboratory for testing of samples for coronavirus called “Fiere Eye” was opened at the Clinical Centre of Serbia in Belgrade on April 20 this year. The central air-conditioning system of the laboratory with extremely strict hygienic and internal parameters of temperature and relative humidity was constructed. Air handling unit that provides the said parameters is a product of the company “Soko Inžinžering” under the designation “K7-4 HG” made in accordance with the standards and recommendations that the systems for this purpose must meet. All tests of authorized validation laboratory confirmed the required parameters.

## About the Laboratory

The new laboratory for testing samples for the “Fiery Eye” coronavirus is a donation from the Chinese BGI Institute. It was modeled on the best laboratory in the city of Wuhan, with which China managed to defeat this pandemic. The very name of the laboratory comes from the Chinese myth in which the “fiery eye” can see every spirit and devil.

The capacity of the laboratory is 2,000 samples per day, which is equal to the capacity of all other laboratories in Serbia where coronavirus samples are currently being tested. This lab significantly accelerated the testing of samples for Covid-19, and thus helped suppression the

spread of this global pandemic. It employs 40 health workers, molecular biologists, in three shifts, seven days a week.

The second laboratory is in the city of Nis and has a capacity of 1,000 tests per day.

The laboratory is located within the Clinical Center of Serbia Figure 1. The facility is designed as a separate unit and has 750 m<sup>2</sup>, of which clean rooms of class ISO8 occupy an area of 300 m<sup>2</sup>, with 12 separate rooms.

## Challenge they face

The company Soko Inžinžering has been present on the market since 1992, and it deals with the production of



Clinical Center of Serbia in Belgrade.

air-conditioning, heating and cooling equipment, as well as the execution of all mechanical and BMS installations.

At the time of state of emergency, when the virus pandemic reaches its peak worldwide, when everyone is facing unknown, in the phase of elaborating a technical solution due to unconfirmed technology, the task was set to produce air handling unit, air ducts, to install complete equipment in the facility and to put the entire air-conditioning and ventilation system into operation. A specific challenge was to procure appropriate elements, organize production, install in the facility and successfully put into operation, in aggravating circumstances and a short period of 15 days, in order to meet all set requirements.

Faced with the challenge, they were given security by numerous references from the field of medical institutions and hospitals, their own production, as well as the fact that they have been holding Eurovent Certificate for air handling units for 7 years and are successfully passing all tests in terms of quality (strength, sealing, thermodynamic performances, ...).

### Technical task

- The laboratory air-conditioning system is a separate system with respect to other air-conditioning systems of the Clinical Centre.
- Hygienic construction in accordance with the standards and recommendations for this purpose systems.
- Application of ventilation with fresh air dilution and laminar flow at low speed, without the possibility of air recirculation.
- The adopted amount of air corresponds to a larger number of air changes, in order to prevent the deposition of particles.
- Use of high efficiency filters, ePM1, intended to stop particles up to 1 micron in size. Filtration efficiency of 50% in the first stage, then of 80% in the second stage and with absolute filters at the end, having an efficiency of 99.97% for particles with a size of 0.3 microns.
- Adequate distance is provided between exhaust air discharge point and fresh air intake with mandatory filtration of exhaust air, so as to prevent fresh air contamination.
- Controlled ventilation system preventing the penetration of the air from contaminated part to other areas, in terms of appropriate underpressure/overpressure and prevention of exfiltration / infiltration of particles.
- Achieving appropriate temperature and relative humidity parameters.

### Adopted parameters and final construction

The two stage air handling unit was chosen, operating with 100% fresh air of 18,000 m<sup>3</sup>/h.

On Figure 1 is given Mollier's Diagram showing the changes in air conditions for external design parameters in winter and summer period and Figure 2 shows air handling unit configuration.

Heating capacity of 200 kW with hot water regime of 80/60°C from the district heating system was adopted. Cooling capacity is 175 kW with cold water regime 7/12°C from the existing chiller plant.

For the second laboratory, which was opened three months later in Nis, refrigerant R410A was used as a cooling medium, and independent cooling system with Hitachi "Utopia DX" condensing units.

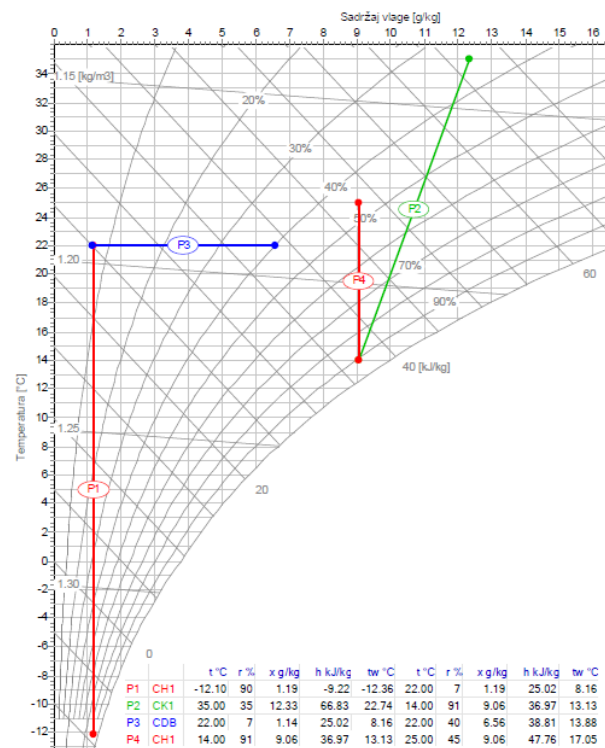

Figure 1. Mollier diagram (h,x chart).

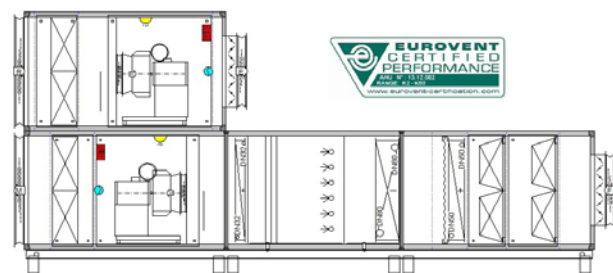

Figure 2. Air handling unit configuration.

It is planned to maintain relative humidity within the limits from 40% to 60%, because this range is least suitable for microorganisms. Class F7 and F9 fine filters were installed on delivery side. Absolute H13 filters were installed, both on delivery, and exhaust side of the air handling unit. Fans with variable rpm speed were used, in order to achieve appropriate pressure difference.

Air distribution ducts play an important role in air-conditioning and ventilation system, because they significantly affect the air quality and energy efficiency of the entire system.

Special attention was paid to very process of fabrication and proper installation of the ducts, whereby uniform air distribution, the highest class of sealing (air-tightness), hygienic adequacy and easy maintenance. **Figure 3** shows Air handling unit in the facility in installation phase.

**Figure 4** shows Laboratory in equipment installation phase in city Belgrade and **Figure 5** in city Niš.

### Applied standards and recommendations

- EN 1886 – Ventilation of buildings, Air handling units, Mechanical performance
- EN 13053 – Ventilation of buildings, Air handling units, Rating and performance for units, components and sections
- DIN 1946-4 – Ventilation and air handling units in health care areas
- VDI 6022 – Hygienic requirements for ventilation and Air Handling Unit systems, special requirements for systems used in people's occupations (air quality)
- REHVA Guidebook No.9: Hygiene Requirement for Ventilation and Air Conditioning provides guidance on hygiene requirements for planning, installation, maintenance and operation and describes appropriate test procedures and test criteria for ventilation and air-conditioning systems and airhandling units.
- REHVA COVID-19 guidance document [www.rehva.eu/activities/covid-19-guidance](http://www.rehva.eu/activities/covid-19-guidance)
- ASHRAE Position Document on Infectious Aerosols

### Conclusion

Nowadays, the world is facing an increasing threat from viruses and bacteria and no less threat from shortage of energy-generating products. Implementation of all safety measures on the one hand and preservation of remaining



**Figure 3.** Air handling unit in the facility in installation phase.

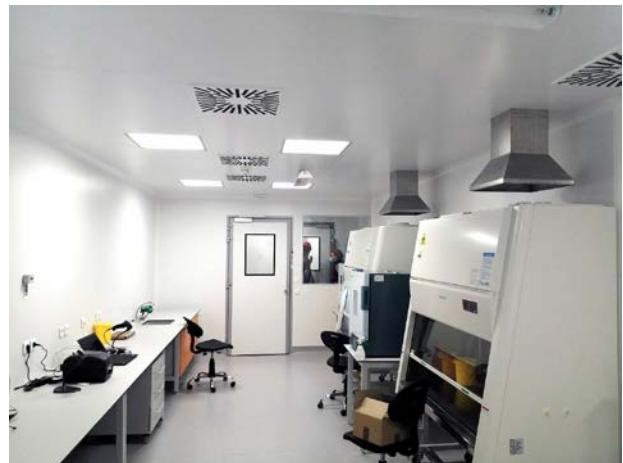

**Figure 4.** Laboratory in Belgrade in equipment installation phase.



**Figure 5.** Laboratory in Nis in equipment installation phase.

energy potentials and the finding of possible savings on the other hand are of exceptional importance. Finding the right balance will be a challenge for heating, cooling and air-conditioning profession in the forthcoming period. ■

# Combined actions of HVAC professionals against Corona and climate crises



**MIODRAG MESAROVIĆ**

Academy of Engineering  
Sciences of Serbia  
mmesarovic@mts.rs

The HVAC professionals are facing the need to adapt their skills and standards to fast changing conditions on a time scale much shorter than the lifetime of the buildings they take care of. This is valid both for the sudden action in response to the COVID pandemic, as well as for the long term climate change with objectives towards carbon neutrality. The report deals with challenges the HVAC professional face in Serbia and elsewhere in Europe.

**Keywords:** COVID pandemic, EPB, IEQ, building renovation, climate change and adaptation

## COVID-19 and Climate crises – a new reality to focus on the European Green Deal

This month (July 21, 2020) the EU leaders reached agreement on their new green package entitled *Next Generation EU*. This package will make fighting climate change central to Europe's recovery from the COVID-19 pandemic, with large sums intended for the 'green' investments and carbon reduction goals. This requires strong efforts of the HVAC professionals to achieve combined objectives in the *Energy Performance of Buildings* (EPB) and the *Indoor Environmental Quality* (IEQ), while reducing the carbon footprint. Obviously, this cannot be reached without adequate innovation of the professional skills and standards and adaptation of the design tools.

## A Challenging Time for the HVAC Professionals

The HVAC professionals refer to a wide range of activities, from research, design, installation and maintenance of the building services. Most of them are already focusing on introducing their best practices on low energy systems, on-site renewable energy production and promotion of low carbon footprints solutions. They have already acquired consistent experience but must adapt their practice to the necessary target of very low carbon footprints buildings without any compromises on the IEQ. This means an evolution towards a new definition of optimal building design in terms of installed power, energy performance and cost, as well as of the IEQ that takes account of the COVID-19 virus infection threats.



The European leaders managed to back a progressive recovery plan providing additional financial resources to tackle the challenge of COVID-19 pandemic. The recovery plan secures financial resources to fund public investment and reform that are essential for a sustainable recovery while stimulating private investments in strategic sectors and strengthening those EU instruments that helped during the COVID-19 crisis. The building *Renovation Wave* is a fast track approach to drive the European economy out of the COVID-19 recession. The renovation of the building stock with a strong reduction of the primary fossil energy use and of the carbon footprint of these renovated buildings becomes a priority. In this aspect, the role of HVAC professionals is to ensure the effectiveness of the renovation which must also comply with the long term EU objective of carbon neutrality in 2050.

This is an extremely complex and difficult task. Very often the envelope characteristics and materials of the building to be renovated are not known. Also, the service systems have to be redesigned completely, and the technical solutions for introducing new installation for heating, cooling or ventilation are much more difficult to handle than in a new building, [1]. This complexity in line with the lack of investment makes the projected ambitious renovation dynamics of a rather old building stock in the Serbian capital city of Belgrade much slower than expected, **Figure 1**, [2]. This made the average energy efficiency of the buildings stock rather low irrespective of very good performances of the new built buildings.

Certainly, before the EPB Directive (EPBD), the energy performance buildings was not a priority. The EPBD

is implemented into the Serbian legislative to promote energy performance of new buildings, and those used by public institutions, while the efficiency of commercial buildings and private dwellings is mainly left to their owners. The training of HVAC professionals on the basis of European standards is found beneficial in order to promote a more unified vision, in complement to the national regulations. Developing a common training and mutual recognition of their skills could be a very valuable contribution of HVAC associations [3].

Until recently, the main focus of HVAC professionals was on improving the energy performance of buildings while reducing the direct and indirect CO<sub>2</sub> emission caused by heating, cooling and ventilating, as well as on improving the indoor environmental quality. Today the objective of preventing the spread of the COVID-19 virus must be added. Due to an unprecedented urgency to act, REHVA published its COVID-19 guidance on how the HVAC community have to safeguard a healthy indoor environment to bring the infection risk to a minimum by the correct use of ventilation and air conditioning systems [4]. The first version has been issued in March 2020 and followed by updates in April (2nd version) and August 2020 (3rd version). The third version of the REHVA guidance is focusing on how to reopen and safely use buildings after the lockdown. Particular care is needed by the air systems where air is used not only for ventilation but also for energy transfer (heating/cooling). Renovation of these systems must satisfy both the EPB and IEQ objectives at the same time. This means an evolution towards the new definition of optimal solutions in the system design in terms of IEQ, installed power, energy performance and costs.

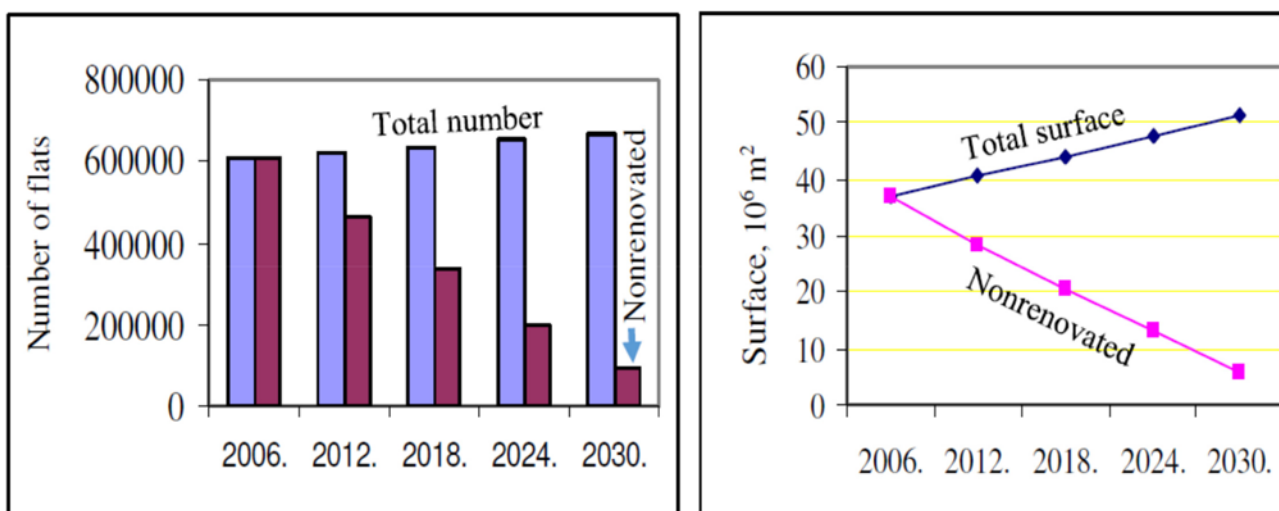

**Figure 1.** Projected number and surface of flats to be renovated in Belgrade.

## While Waiting for the New Ice Age to Come

The new reality brought about by the COVID-19 health crisis has reinforced the need to align the climate goals of the European *Green Deal* with the post-pandemic economic recovery. Implementing the European *Green Deal* would boost demand and encourage investment. Implementation of the international climate agreements provides an investment impulse in the EU economy. Long a leader in progressive climate change legislation, the EU increased those ambitions recently and pushed forward a stimulus package to revive its pandemic-ravaged economies. The building *Renovation Wave* makes the role of the HVAC community of the prime importance to the recovery of the European economy from the COVID-19 recession.

On the way towards carbon neutrality, the HVAC professionals have already introduced their best practices to low energy systems, on-site renewable energy production and promotion of the low carbon footprints solutions, such as the *Nearly Zero Energy Buildings* (nZEB). Now they have to adapt their practices to the very low carbon footprints buildings without any compromises on the *Indoor Environment Quality* (i.e.: comfort, health and safety). Simultaneously, they must be ready to adapt their long term building solutions to potentially changed climatic conditions if the anthropogenic emissions of greenhouse gases continue.

The famous climate accord on the COP 21 climate summit in Paris 2015 aims to limit global warming to well below 2°C, with efforts to keep it below 1.5°C, in order to limit the worst impacts of climate change. To be on track for 2°C of warming, emissions in 2030 would need to be 25% lower than today, while to limit warming to 1.5°C, emissions would need to be slashed by 55%, [5]. However, of the Paris climate commitments by 184 countries, only 36 have made pledges that could conceivably reach the 2030 goal, the rest being not so ambitious or urgent enough. Some even refuse to act. Confirmation that rising emissions are putting existing global goals further out of reach came on the COP 25 climate summit in Madrid.

As the emissions continue to rise (last year, global CO<sub>2</sub> emissions rose 1.7%), for every year that action is delayed, emissions reductions need to be much steeper, **Figure 2**, [6]. Some scientists even warn that, otherwise, the global climate stability might be endangered. **Figure 3** shows the pathway of the reversal of

the Earth climate system from its pathway towards so called *Hothouse Earth* and stabilise within the glacial–interglacial cycles ([7, 8]), thus ensuring survival of many current species on Earth.

The greater the delay in reducing emissions within the remaining carbon budgets for 1.5 and 2°C, the more difficult will be for the HVAC professionals to timely adjust their standards and practices to the dynamics needed to achieve the objectives of the Paris Agreement (**Figure 2**). One could hardly imagine how difficult it would be for them if the humanity fails to stabilise the climate system (**Figure 3**). Based on their historical experience with the short-term climate variation, the HVAC community established good standards and design tools, that, with necessary upgrades, could meet the requirements arising from such variations and associated weather extremes, such as heat waves, for example. More difficult for them, as well as for the human population as a whole, would be to adapt to a climate beyond the known variations.

Some scientists are denying the anthropogenic impact on global warming (even claiming that the Earth is experiencing a global cooling instead) so that emissions do not have to be cut down since the climate changes are exclusively driven by the natural phenomena, as already experienced during long preindustrial history, [8]. Climate science, however, does not deny, but takes due account of all the known natural phenomena that drive the climate change and combines them with those arising from the human activities.

Natural climate change is driven primarily by the orbital dynamics of the solar system which produces regular warm and cold cycles on Earth in intervals roughly 100,000 years long. Exactly a century ago (1920), Serbian astronomer and mathematician Milutin Milanković was first to explain the episodic nature of the Earth's glacial and interglacial periods which have been caused primarily by the cyclical changes in the Earth's circumnavigation of the Sun, [9]. More precisely, variations in the Earth's eccentricity, axial tilt and precession comprise the three dominant cycles, collectively known as the Milanković's Cycles, as he is generally credited also with precise calculation of their magnitude. Taken in unison, variations in these three cycles create alterations in the seasonality of solar radiation reaching the Earth's surface. These times of increased or decreased solar radiation directly influence the Earth's climate system, thus impacting the advance and retreat of the Earth's glaciation.

The solar radiation (insolation), regularly changed according to Milanković's cycles, has direct or indirect effects on the atmospheric concentration of greenhouse gasses such as water vapour and CO<sub>2</sub>, with the levels being determined by a variety of complex feedback mechanisms that tend to turn the climate from warm to cold and back again, [10]. Currently, the natural global

warming and cooling that work in slow, complex cycles, is being overridden by the human activities particularly increasing since the inception of industrial revolution. Even if the CO<sub>2</sub> emissions stop, their effects would continue for centuries, a long time by human standards. As Milanković's theory predicts, the Earth would resume its slow descent into the next *Ice Age* many tens of thousands of years from now. Climate variation and weather extremes will resume as well.

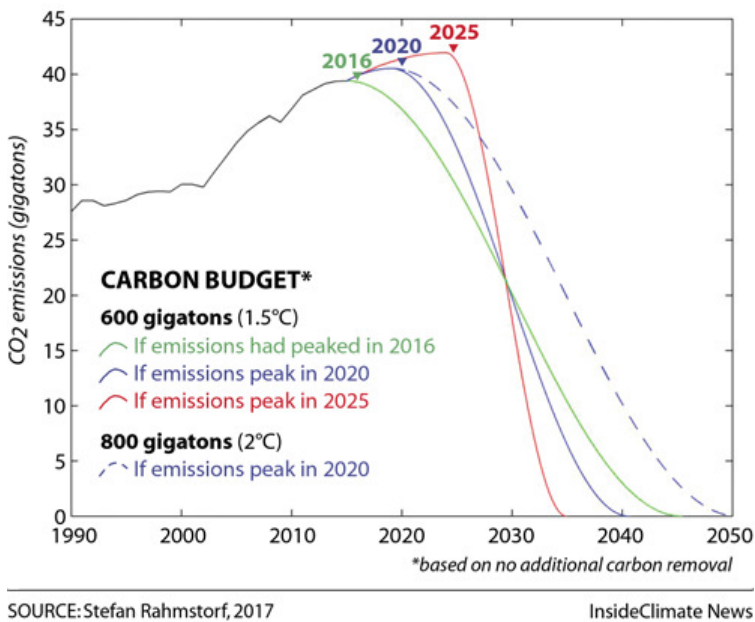

Figure 2. Use of Carbon budgets for 1.5 and 2°C goals.

Today, a reliable, physically sound determination and prediction of the global climate changes, as well as predictions of the relevant global, regional and local climate parameters is particularly important for the sustainable, life cycle energy efficient buildings/HVAC systems holistic design, [11]. Not all European citizens enjoy a relatively mild climate, so that HVAC standards and practices may vary. Major change of the temperature is expected in the North Europe due to melting of the ice-caps and consequent changes of the oceanic current system. If warm currents carrying heat from the tropics to Europe would rearrange, it could make most of the current HVAC infrastructure unsuitable. The HVAC

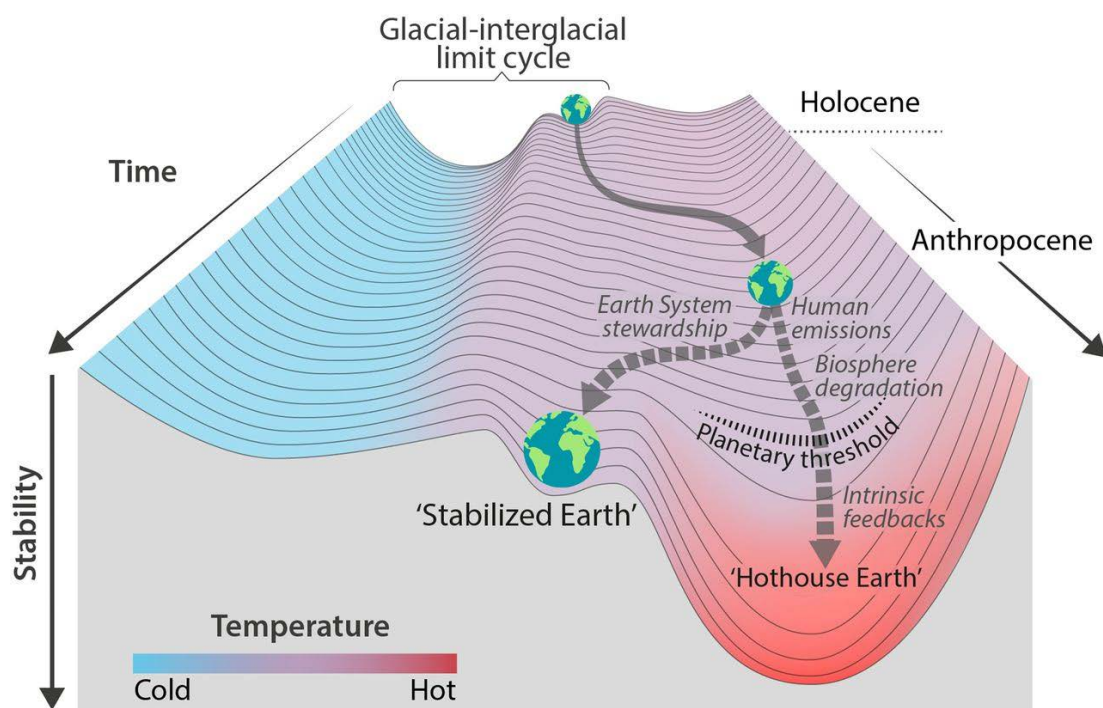

Figure 3. Earth's climate on the crossroads.

community will also be in difficulties even if the current pledges are fully implemented, as they would not lead to 1.5°C or 2°C goals but to 3°C to 4°C temperature rise above preindustrial level, [12]. It should be noted that the temperature on land where humans live is above these land-ocean averages, Figure 4 [5, 13].

## Conclusion

The HVAC professionals play an important role in implementing energy efficient solutions, especially in building renovation where HVAC systems are often replaced or upgraded in shorter intervals. The new challenge is a dynamic compliance with future building performance requirements and higher degree of sophistication and details, when moving towards nearly zero energy and carbon neutral building. ■

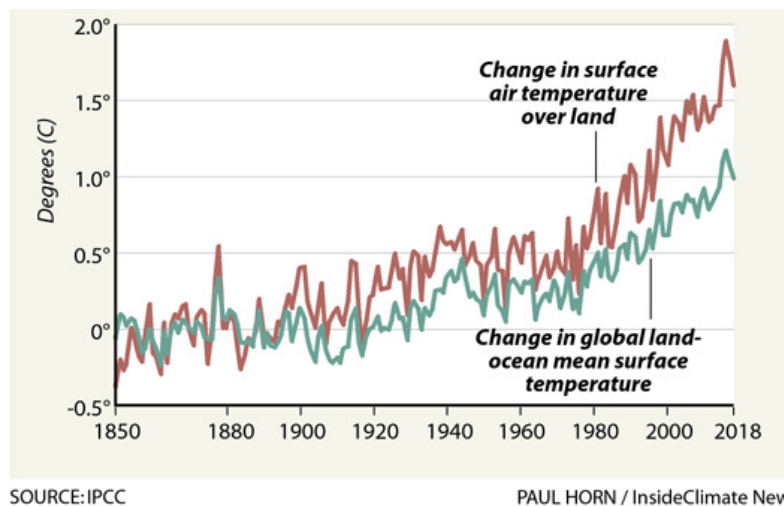

Figure 4. Difference between land and land-ocean surface temperature rises.

## References

- [1] Allard, F. Interview on new challenges of HVAC professional, REHVA journal, Vol.57, Issue 3, June 2020, p. 5-6
- [2] Energy development strategy of the city of Belgrade, - Section 3: Projected energy demand Energoprojekt, Belgrade, 2008
- [3] Hogeling, J., COVID-19 and Climate crises – a new reality to focus on the European Green Deal, REHVA journal, Vol.57, Issue 3, June 2020, p. 4.
- [4] [www.rehva.eu/activities/covid-19-guidance](http://www.rehva.eu/activities/covid-19-guidance), Approached 03.08.2020.
- [5] Berwyn, B., IPCC: Radical Energy Transformation Needed to Avoid 1.5 Degrees Global Warming, [www.insideclimate.org](http://www.insideclimate.org), Approached 04.08.2020.
- [6] Gustin, G., The Paris Climate Problem: A Dangerous Lack of Urgency, *InsideClimate News*, Nov 7, 2019.
- [7] Steffen, W. et al., [Trajectories of the Earth System in the Anthropocene](https://doi.org/10.1073/pnas.1811835115), PNAS 2018; 115:33. pp 8252-8259, ©2018 by National Academy of Science, Washington DC.
- [8] Mesarović, M., Scientific Uncertainties Feed Scepticism on Climate Change, *Thermal Science*, 19 (2015), Suppl. 2, pp. S259-S278.
- [9] Milanković, M., *Mathematical Theory of the Thermal Phenomena Caused by the Solar Radiation* (in French), Gauthier-Villars, Paris, 1920.
- [10] Mesarović, M., Global Warming and Other Climate Change Phenomena on the Geological Time Scale, *Thermal Science*, 23 (2019), Suppl. 5, pp. S1435-S1455.
- [11] Todorović, M. S., In Search for the Global Warming Proof – Milutin Milanković's Earth Mathematical Climate and Ice Ages, *ASHRAE Transactions*, 2014.
- [12] <https://feu-us.org/behind-the-climate-pledges1/>, Approached 04.08.2020.
- [13] Berwyn, B., [The Worst-Case Scenario for Global Warming Tracks Closely With Actual Emissions](http://www.insideclimate.org), *InsideClimate News*, [www.insideclimate.org](http://www.insideclimate.org), Approached 02-08-2020.

# ECOROBOT for total cleaning & destruction of microorganisms on air-obstructed HVAC'S internal surfaces



**BORIŠA MILEKIĆ**

PhD, graduated electrical engineer, Impuls Clinic, Belgrade, Serbia  
bobanv@eunet.rs



**DRAGAN ŠKOBALJ**

PhD, graduated mechanical engineer, International University Brčko District  
p.skobalj@gmail.com



**PREDRAG ŠKOBALJ**

PhD, graduated mechanical engineer, University of Belgrade, Institute of Nuclear Sciences VINČA, Serbia  
p.skobalj@vinca.rs



**VALENTINA TURANJANIN**

PhD, graduated mechanical engineer, University of Belgrade, Institute of Nuclear Sciences VINČA, Serbia  
valentin@vinca.rs

The microorganisms may enter the HVAC systems from outdoor or indoor environment. These microorganisms can survive in various HVAC components: air ducts, filters, heat exchangers and fan coils, and could be transmitted and spread to indoor in the form of bio-aerosols or accumulated dust with supply airflow. At the start of COVID-19 pandemic, in order to prevent the airborne spreading of SARS-COV-2, a lot of the HVAC systems in buildings were not in operation. Ten years ago has been invented device so called ECOROBOT which can help us to destroy microorganisms from HVAC systems and breathe “healthy” air.

**Keywords:** ECOROBOT, HVAC system, microorganisms, remote controlling, quality air

Comfortable environmental conditions (temperature and humidity) and clean air in indoor settings such as buildings and vehicles are provided by heating, ventilation and air-conditioning (HVAC) systems. Depending on the application and the functions of the building, HVAC systems can be configured in a variety of ways. Increased transmission of respiratory infections is associated with poor ventilation in indoor spaces. There have been numerous

COVID-19 transmission events associated with closed spaces, including some from pre-symptomatic cases [1]. When it's not possible to clean and disinfect channels regularly, the air can become contaminated, which can significantly endanger people's health. Ventilation and air in HVAC systems conditioning channels are very susceptible to microorganisms growth. The channels have not enough light. They are damp and there are enough particles to grow a base. Air distribution

channel become an incubator for the growth of bacteria, viruses and fungi which reach to human working and living environment and via respiratory organs, hands, food and water they finally reach into the very human organism. It is very serious problem for humans.

### Cleaning and disinfecting ventilating and air distribution channels needs

Within central system for air distribution structure, it is already included filter section on air conditioning chamber that prevents transit of dirt. However, filters let fine particles small enough to be measured in nm to pass through them, and they halt on the ventilating channel walls and create lamination of dirt. Exploring and sampling of lamination from the ventilating channel walls for air distribution show presence of viruses and bacteria in lamination. Ventilating channel is suitable habitation for viruses and bacteria because of its huge moisture and no light. Viruses and bacteria get to the respiratory human organs via grid for air distribution.

Based on many years of research it was created a device so called ECOROBOT for destroying viruses and bacteria in air conditioning channels ([2], [3]), ECOROBOT (Figure 1) device is used for destroying viruses and bacteria in airing channels, in order to provide clean and quality air to the indoor environment. It is used in buildings with forced ventilating and air conditioning, in business and residential buildings, hospitals, banks, cinemas, theaters, restaurants, hotels, airports, sport and production halls [4]. Its functions are: cleaning lamination, suction of lamination, disinfection of channels, drying of channels. After functions performed, all lamination is eliminated. The lamination is packed and sterilized properly and handed over to ravage procedure. Viruses and bacteria are destroyed and clean and quality air is provided to the space.

The device performs four operations within a defined work area. Destroying viruses, bacteria and other micro-

organisms can not be infiltrated into working space through flowing vents. An intake manifold prevents this from happening and rear rotation creates an air bag thus preventing microorganisms to infiltrate into cleaned zone. After viruses and other microorganisms destroying process performed, the device disinfects and dries the channels. The channel positioned after the device remains completely protected from eventually harmful microorganisms. Ravaging agents for viruses and other microorganisms are biodegradable and leave no consequences on human health.

ECOROBOT performs cleaning and disinfection of all types of channels (horizontal, vertical, flexible, rectangular, round) from Ø 100 to Ø 2,000 mm.

In Republic Serbia there is legal regulation for maintenance of channel airing systems. Legal regulation comprises of The Law for occupational safety and health as well as of The Rules for preventive actions for safe and healthy work on work place. Based on above mentioned law, employer has an obligation to provide maintenance of working tools (air conditioning installation) on the work place. Figure 2 shows ECOROBOT operating in a rectangular channel.

### Basic parts of ecorobot and its operation principles:

1. Front rotational nozzle is used for taking off the lamination deposited on channel walls with adjusted speed. An intake manifold prevents the lamination from infiltrating into the front section, thus preventing it from protrusion through flowing vents and entering of virus particles into a working space.
2. Rear rotational turbo nozzle can change number of rotations in order to achieve appropriate speed and create an „air bag“ which stops protrusion of viral and bacterial particles into cleaned space.

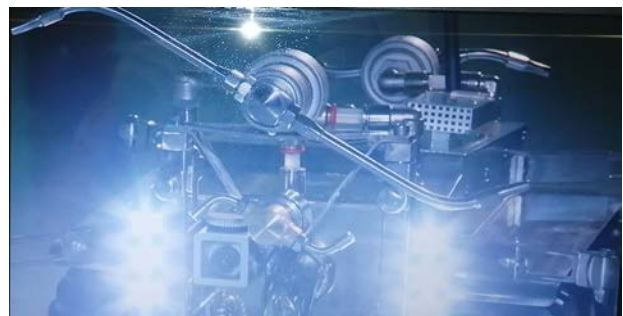
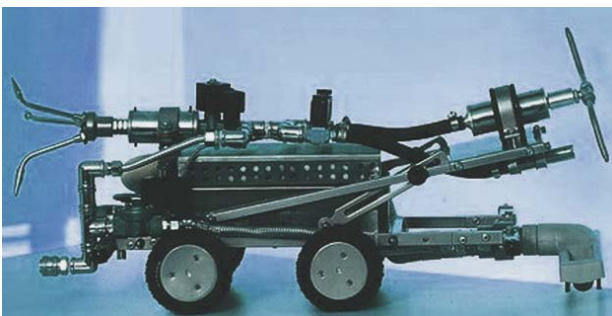

Figure 1. Two views on the ECOROBOT.

3. The intake manifold has capacity to suck everything which is taken off the channel walls, it is provided by appropriate speed of turbo rotational nozzle. The nozzle can operate with adjustable speed, it is adjusted in accordance with quantity of material in the intake manifold.
4. After gathering of viruses, bacteria, fungi and other lamination performed, ecorobot packs them into a reservoir and later sends them to an autoclave machine
5. Front turbo rotational nozzle has smaller dimensions from the nozzle for taking off the lamination. The nozzle has a function of disinfection and ravaging of remaining viral particles and other microorganisms on the film wall. This function is provided by reverse action, when turbo nozzle is protecting the film in order not to plant and fertilize microorganisms and viral particle again and not to produce eventual mutant of unknown origin. The mutant can damage human organism in significant extent, and quality treatment is performed only after its origin is defined.
6. In the next step it is provided simultaneous functioning of the front and rear turbo rotational nozzle, which perform thrust of biocide agents for ravaging

of viruses and drying of channel walls. New technologies at the entry of air conditioning chamber use filters capable to eliminate particles measured in  $\mu\text{m}$ . Viral particles have dimensions in nm and that is the reason why great number of viruses can be found on channel walls. These invisible viruses and microorganisms can be cleaned equally effective with a wireless robot.

The most common technique is impression of microorganisms because of its reliability. It is easy to perform, it's economic and reliable. Author's idea was to make a functional device of perfect function which will move freely through ventilating channel. The device has to work within working area.

Cleaning of rectangular channels is solved by stable self-propelled robot adaptable to different dimensions and the same principle can be applied in round channels. One of the problems was cleaning of vertical channels. For these purposes it was made turborotational self-propelled nozzle device which uses its own drive by a reactive spray and which uses turborotational circular spray for keeping the device within the axle of channels with smaller diameters. In this way it is provided quality

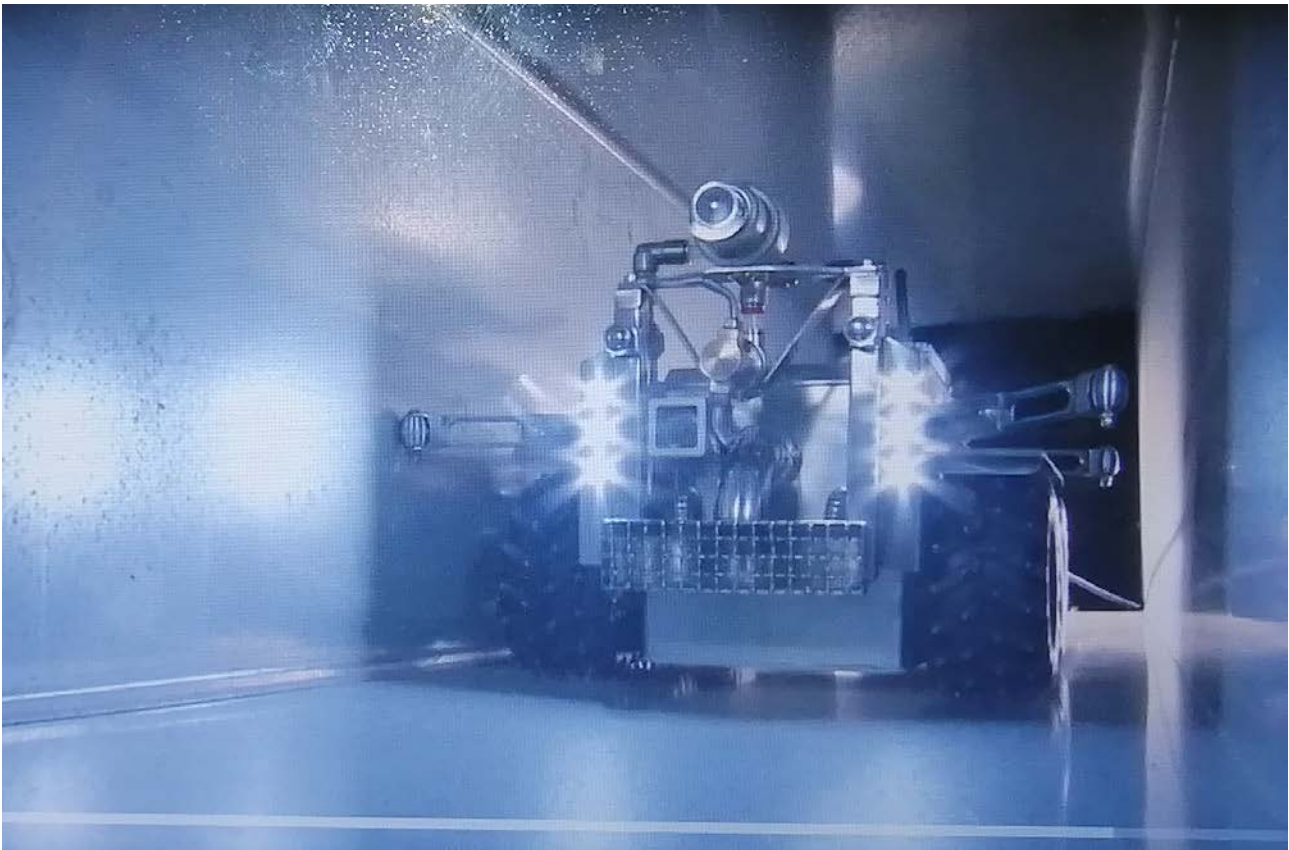
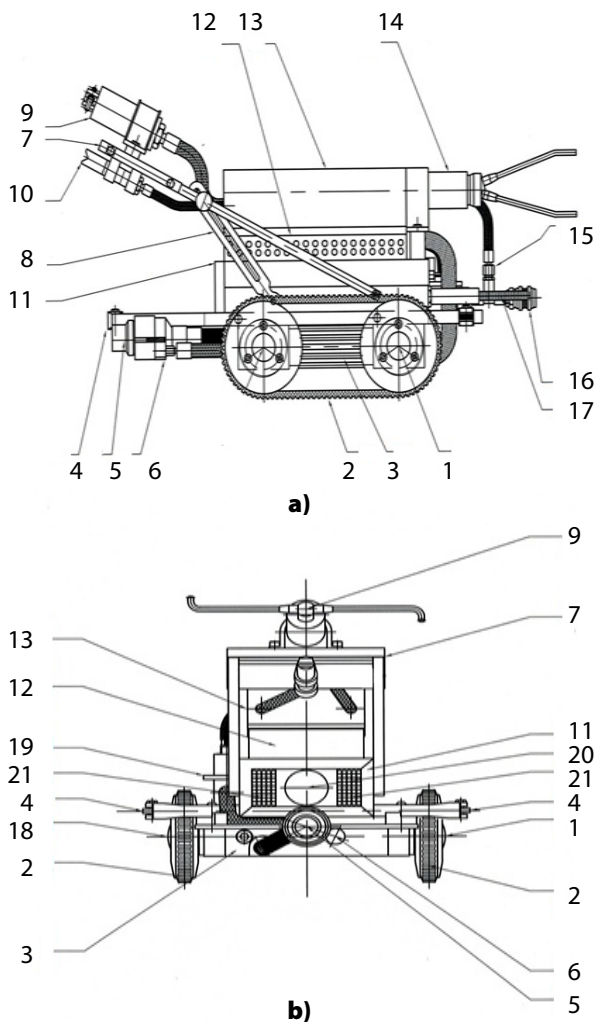

Figure 2. ECOROBOT operating in a rectangular channel.



| Pos. | Name   | Figure |    |
|------|--|--------|----|
| 1    | Right drive  | a)     | b) |
| 2    | Timing belt  | a)     | b) |
| 3    | Base   | a)     | b) |
| 4    | Suction buffer   | a)     | b) |
| 5    | Suction throat   | a)     | b) |
| 6    | Suction nozzle   | a)     | b) |
| 7    | Rotational platform of the front nozzles                               | a)     | b) |
| 8    | Base for rotational platform   |        | b) |
| 9    | Front rotational nozzle  | a)     | b) |
| 10   | Front rinsing nozzle   | a)     | b) |
| 11   | Housing with front and rear camera with a light                        | a)     | b) |
| 12   | Basket with a suction bag  | a)     | b) |
| 13   | Housing with electromagnetic valves                                    | a)     | b) |
| 14   | Rear rotational nozzle   |        | b) |
| 15   | Intake of compressed air for electromagnetic valves in the housing     |        | b) |
| 16   | Connection for intake of compressed air from the compressor            |        | b) |
| 17   | Supply electric cable from control panel                               |        | b) |
| 18   | Left drive   | a)     |    |
| 19   | Electromagnetic valve for intake of compressed air into suction nozzle | a)     |    |
| 20   | Front camera   | a)     |    |
| 21   | Front light  | a)     |    |

Figure 3. ECOROBOT (Self-propelled device for cleaning and disinfection of ventilating channels) with marked components.

cleaning and ravaging of viruses and bacteria in vertical and horizontal channels of smaller diameters. Figure 3 shows ECOROBOT components.

### Conclusions

ECOROBOT is much more than ordinary technical invention. Strategic aim is to make ECOROBOT known through its mass acting in every building with forced ventilation and air conditioning, enable its presence in all kind of buildings and to make it accessible to all of us. ECOROBOT is one of the inventions keeping our hope in better, nicer, healthier and safer future world. Its multifunctional technical/biophysical features and performance should be further measured and investigated and based on the existing laboratory level constructed devices should be developed industrial level devices production tracing worldwide

encouragement and vision of the roadmap of resilience and salvation. ■

### References

- [1] European Centre for Disease Prevention and Control: Heating, Ventilation and air-conditioning systems in the context of COVID 19, 22 June 2020.
- [2] "Impuls" Clinic, : Project of robot for disinfection of HVAC, Belgrade, 2012.
- [3] Milekić B., Patent: "Device for automatic cleaning and disinfection of ventilation ducts", Registered 9. 3. 2012., valid till 29. 7. 2028. According to Patent document Nr 52089, The Intellectual Property Office, Republic of Serbia.
- [4] "Impuls" Clinic: Internal report for Ministry Defence building disinfection of HVAC system, Belgrade, 2016.



# COVID-19: Challenges and opportunities in the district energy sector



**GREG GEBRAIL**

Energy Specialist, Sustainable Infrastructure Group, European Bank for Reconstruction and Development (EBRD [1])  
gebtrailg@ebrd.com



**BOJAN BOGDANOVIC**

Fund Manager – Renewable District Energy in the Western Balkans Fund (ReDEWeB), Sustainable Infrastructure Group, EBRD  
bogdanoB@ebrd.com

District energy (DE) systems are commonplace in urban centres and district heating (DH) is the most common form of heating for urban homes and businesses in many of EBRD's countries of operations (COOs [2]). Compared to other utility sectors, the seasonal timing of the COVID19 pandemic means the immediate risk surrounding increased demand for services is minimal. However, the outbreak and the drastic measures taken in response raise issues that sector operators and policymakers should be aware of which are outlined below:

## Demand

With the vast majority of the population now required to stay at home, an increase in residential demand for space heating and domestic hot water would be expected, alongside a significant decrease in commercial and industrial heat demand. Fortunately, by the time EBRD regions locked down, the period of peak heating demand had already passed and DH systems were operating with sufficient spare generation capacity. As the lockdown progressed, the weather got



milder and systems either have ended their heating seasons. This is also applicable to regions where residents rely on natural gas networks and individual boilers for heating.

District cooling systems are not yet widespread in our COOs, but when the pandemic takes hold in warmer countries during the summer, lockdowns could increase residential cooling demand and strain urban electricity grids.

## Operations

Public utilities such as DH operators are under pressure to deliver critical services while also facing a shortage of working capital due to Government policies suspending or delaying tariff payments by the population. They may no longer have sufficient working capital to keep systems operational, pay staff or fund planned infrastructure investments (which may include essential maintenance that must be completed in the summer

months). The risk here is obvious and EBRD can support DE operators to overcome this risk through the Bank's new Solidarity Package. (<https://www.ebrd.com/what-we-do/coronavirus-solidarity>).

Fuel supply may be impacted by the working capital issues outlined above but the pandemic is unlikely to cause interruptions unless there is a severe economic shock or political unrest.

### *Possible EBRD response for district energy services:*

| Type of support  | Ambition   | Investment  | Implementation period   |
|--|--|---|-------------------------|
| Provision of capital investment to secure / improve district energy net-works        | Provide a continuous supply of thermal energy (heating or cooling) to the residential, commercial and industrial sectors | <input type="checkbox"/> Metering with remote reading capabilities at critical network points to enable rapid detection of network faults                                       | Short Term (3-6 months) |
|  |  | <input type="checkbox"/> Individual heat substations for residential buildings with remote communication  | Medium Term (>6 months) |
|  |  | <input type="checkbox"/> Real-time monitoring and control infrastructure with remote management capabilities  |                         |
|  |  | <input type="checkbox"/> Accelerate pipeline replacement  |                         |
| Provision of capital investment to secure / improve heat generation facilities       | Generate a continuous supply of low carbon thermal energy matched to DH net-work demand                                  | <input type="checkbox"/> Overhauls or major maintenance on boilers or other critical plant  | Short Term (3-6 months) |
|  |  | <input type="checkbox"/> Facilities for the safe long term storage of solid or liquid fuels   | Medium Term (>6 months) |
|  |  | <input type="checkbox"/> Focused improvements that drive cost efficiencies  |                         |
|  |  | <input type="checkbox"/> Accelerate investment in low carbon heat generation  |                         |
|  |  | <input type="checkbox"/> Pollution control equipment for natural gas boilers with high utilisation and long remaining lifespans (low NOx burners, flue gas recirculation, etc.) |                         |
| Provision of working capital investment to secure / improve district energy services | Improve operational resilience through recovery and response measures  | <input type="checkbox"/> Large scale thermal storage at CHP plants  | Immediate (0-3 months)  |
|  |  | <input type="checkbox"/> Cover operational costs: fuel, materials, employment etc.  |                         |
|  |  | <input type="checkbox"/> Fund pre-planned summer maintenance  |                         |
|  |  | <input type="checkbox"/> Where safe storage facilities exists, fund additional purchases of solid or liquid fuels   |                         |
|  |  | <input type="checkbox"/> Emergency spares provision (equipment, tools and materials)  |                         |
| <input type="checkbox"/> Provision of operator PPE                                   |  |   |                         |
| Policy support for district energy   | Support the DE sector's transition to low carbon energy sources and ongoing commercialisation of services                | <input type="checkbox"/> Immediate support for training covering social distancing-compliant working practices  | Short Term (3-6 months) |
|  |  | <input type="checkbox"/> Emphasise the Bank's support for the decarbonisation of heating and cooling  | Medium Term (>6 months) |
|  |  | <input type="checkbox"/> Policies that enable DH extension and removal of polluting local boilers/furnaces which affect respiratory health                                      |                         |
|  |  | <input type="checkbox"/> Continue to support sector tariff reform and targeted subsidies for vulnerable consumers   |                         |

Workforce absences are a risk, particularly in COOs where there is still widespread manual supervision and operation of system infrastructure. Social distancing measures could also affect maintenance activities and operators will have to train staff and provide appropriate Personal Protective Equipment (PPE), especially where contact with the public is required. The situation could be exacerbated by the age profile of the DH sector across the EBRD region; a significant portion of the workforce is over fifty years old [3] and at a greater risk of respiratory illness. The above points could all negatively affect the security of heating supply.

## Investment

The shortage of working capital and immediate funding needs for emergency services could result in a freeze or substantial reduction in capital investments, including projects already under construction. Delaying maintenance or system improvements will negatively affect system reliability and operational efficiency in the medium and longer term.

## Transition to Low Carbon Energy Sources

The combination of depressed energy demand due to the pandemic and the price war between major producers has caused a drastic drop in fossil fuel prices and demand for CO<sub>2</sub> allowances (EU ETS). There is concern that this will reduce the impetus to pursue further decarbonisation in the heating and cooling sector and the temporary price cut may negatively influence planned investments or policies that support renewable or waste heat-based solutions. To maintain momentum, it is important that support for low carbon solutions continues and is made more robust in the face of these challenges.

## Long Term Impacts

The drop in fossil fuel prices will negatively affect government revenues in COOs with a large oil and gas sector such as Kazakhstan. Depending on the length of the downturn, subsidies or artificially low utility tariffs may no longer be sustainable and tariff reform may move up the agenda. The opposite may be true in other countries where authorities may face longer term pressure to freeze or reduce tariffs in the face of increased unemployment or widespread economic hardship.

Rudimentary home heating systems based on solid fuels and local fossil-fuel based boilers are key sources of urban air pollution. The pandemic has also further highlighted the negative impact of air pollution on public health. Researchers at Harvard have noted an alarming correlation between levels of fine particulate pollution in American counties and death rates from COVID-19 in those counties. [4] This may further increase the long-term trend of government authorities or policymakers supporting the expansion of DH services to combat poor air quality in their cities and regions.

In the absence of a vaccine, there is risk that COVID-19 may follow a similar pattern to the seasonal flu and re-emerge in late autumn or winter. The risk of another outbreak and lockdown that coincides with the beginning of the heating season or occurs during the colder winter months further emphasises the importance of completing summer maintenance activities, increasing system redundancy and putting contingency plans in place in case of high staff absences. Ensuring the long-term reliability of systems and security of heat supply will be critical to protecting vulnerable residents who would be most disadvantaged if service is interrupted. ■

## References

- [1] The EBRD is owned by 69 countries, as well as the European Union and the European Investment Bank.
- [2] COOs: Countries of Operation of EBRD.
- [3] The average age of the ~2000 staff at the Belgrade DH operator is 50 years old (2020 Business Plan).
- [4] The Economist – 25th of April 2020 <https://www.economist.com/united-states/2020/04/25/think-a-respiratory-virus-pandemic-is-a-good-time-to-cut-air-quality-regulations> and 18th of April 2020 <https://www.economist.com/united-states/2020/04/18/american-inequality-meets-covid-19>

# Neolepenism – the new thermal comfort construction facilities



**NENAD B. MILORADOVIĆ**

B. Mech. Sc engineer for heat distribution  
PUC Beogradske elektrane, Belgrade, Serbia  
neolepenism@gmail.com  
<http://www.neolepenism.house>

Space design can be one of the strategies for designing low-energy and passive houses and buildings. Neolepenism is a new, internationally copyrighted type of energy efficient architecture with roots in the prehistoric culture of Lepenski Vir (Serbia). The author has previously presented the model of a small family house of neolepenism with a flat roof at 50th Congress and Exhibition of KGH in Belgrade in 2019 and wrote about the energy efficiency of the prehistoric architecture of Lepenski Vir, whose positive experiences he improved and optimized. This new industrial design could significantly contribute to the reduction of heat losses (in winter) or gains (during the summer season), reducing greenhouse gas emissions and saving building materials and thermal insulation, primarily by its compact shape, and to a lesser extent by utilization favorable orientation, by digging in earth, application of green roofs and aerodynamic shape. In this way, neolepenism could have a positive impact on global warming and climate change as a passive means of protection.

Keywords: neolepenism, Lepenski Vir, Green technologies, space design, compactness, surface heating/cooling

## Introduction

Due to energy efficiency and energy savings, engineers must be involved in the work of designing living space, although architects are primarily in charge of that. Designing energy efficient forms can be one of the strategies for designing buildings with low energy consumption.

Recommendations for achieving passive house standards usually state what such a house should contain in

terms of materials and equipment, but not what that house should look like: in [1] it is only considered that “a passive house should have a compact shape with good thermal insulation.” Therefore, architects and engineers must come up with an optimal solution and design through integrated design.

“In general, buildings consume about 40% of the world’s energy. Using the holistic approach of house design, up to 50% of such energy can be saved [2]”.

The most compact shape is the ball. But, the ball is not usable for living. When it comes to orthogonal geometric bodies, the cube is the most compact. The compactness of form of neolepenism architecture is somewhere between the ball and the cube. In this way, neolepenism could have a positive impact on global warming and climate change as a passive means of protection. If we use holistic approach of house design, a lot of energy produced in buildings can be saved, including savings in construction materials and thermal insulation as well as energy for production of these materials.

### Basic information about the archaeological site Lepenski Vir

Lepenski Vir was discovered in the 1960s. The site is well known by its sculptures, architecture and graves. Lepenski Vir is settled on the right, Serbian side of the Danube River in Djerdap Gorge, 15 km upstream from Donji Milanovac and about 160 km downstream from Belgrade.

The person deserving the most merit for its discovery was Dragoslav Srejović, archeologist, whose book *Lepenski Vir – a new prehistoric culture in the Danube region*, published in 1969 by SKZ, is the main source of information on this culture. The site is estimated to be about 8,000 years old. Due to construction of HEP Djerdap 1, the original site was sunken, and the site was displaced due to sinking. The level of the Danube grew by about 12 m, while the current site was moved by some 150 m up to the hill, but the original position was maintained. Nowadays, Lepenski Vir is a museum. The museum preserves the site from devastation due to climatic effects.

Only bases of the houses, made from a hardened material resembling concrete, are preserved; hearths were incorporated in the bases at the entrance, as an active heating system. The third dimension was constructed from perishable materials (like wood, leather, mud...) and is not preserved. We can only assume what those houses looked like.

### What is neolepenism?

Neolepenism is a new type of energy efficient architecture that can respond to the challenges of sustainable development. The name neolepenism is very appropriate because the prefix *neo* signifies something new, while Lepenism refers to the architecture of prehistoric settlement and culture Lepenski Vir. This architecture

of Lepenski Vir controls energy flows, and within it takes into account the optimal orientation of houses in terms of meeting the needs for heating and cooling of these dwellings, as well as the aspect of urbanism of the settlement, about which the author wrote earlier (REHVA Journal, Vol. 5, 2016). The author has improved and optimized these positive experiences of Lepenski Vir architecture. He made a model of a small family neolepenismhouse of 62 square meters with a flat roof: ground and first floor, which he presented at the 50th International Congress and Exhibition of KGH (HVAC) in Belgrade in 2019 (Figure 1) and (Figure 2).

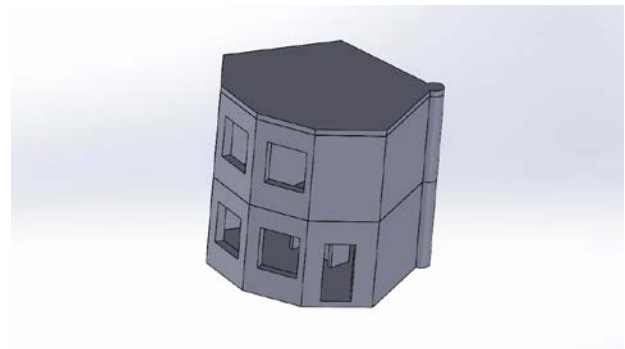

Figure 1. Exterior of a model of a small house of neolepenism of 62 m<sup>2</sup> with a flat roof.

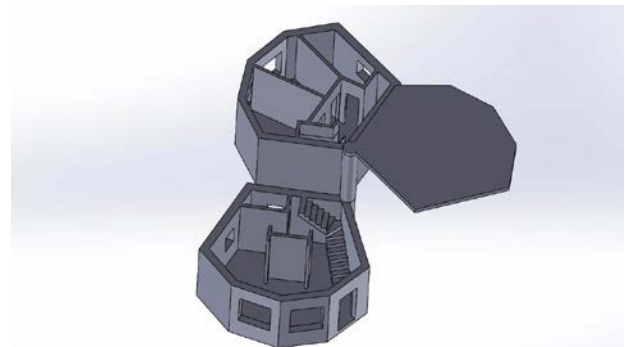

Figure 2. A look inside the model of neolepenism architecture.

We can consider neolepenism as a new Green technology with roots in prehistory. In the process of integrated model design, the author had help of four experienced architects as professional consultants in the field of interior design, one of whom is a PhD and a scientific advisor. The statics of the construction facility was not deeply considered yet and civil engineers also need to be involved. The term neolepenism for this type of architecture was suggested by Serbian actor Predrag Kolarević, when he saw the animations of the model.

The geometric shape and height of an object have influence, to an extent, on energy consumption of heating the object. Designing energy efficient forms can be one of the strategies for designing low energy and passive houses. Compactness of form is very important.

The shape of the construction facility with a flat roof of this architecture was registered as an industrial design in the Intellectual Property Office of the Republic of Serbia, through which international copyright protection was obtained from WIPO – World Intellectual Property Organization in 2020 (Figure 3).

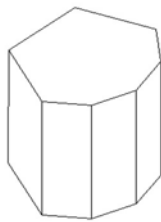

Figure 3. Author's internationally copyrighted form of construction facility with flat roof from WIPO [6].

The architecture of neolepenism has a defined basis (Figure 4), height, orientation and variants. It is a distinctly mathematical architecture. It is based on the adaptation of the object to the natural environment, which includes geographical, meteorological, astronomical and plant environment and takes into account the influence of solar radiation.

The predominantly eastern orientation of the building for flat terrains is recommended, as it presents a compromise between the optimal orientation for the needs of heating and cooling the interior of the building. Solar energy is directly used for heating in the morning, when the greatest needs for that energy are due to lower morning outdoor temperatures and when the incident

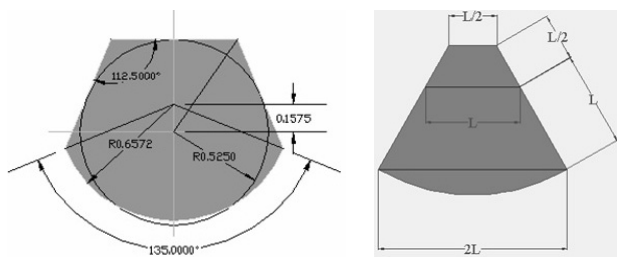

Figure 4. Calculated and optimized Basements of the objects of the neolepenism by author (left) and layout of houses on Lepenski Vir by archeologist D. Srejović [9] (right).

angles of solar radiation on vertical surfaces are most favorable. The meteorological databases Meteonorm of typical meteorological years (TMY) and the Microsoft Excel program were used in the calculations. The calculations were made on an hourly basis for the whole year and are presented by radar diagrams in the literature [4]. Calculations were done for Belgrade (Serbia), Athens (Greece) and Stockholm (Sweden) and similar results was obtained. The radar-diagrams for Athens on (Figure 5) and (Figure 6) are presented just as examples. From those figures we may conclude why the eastern orientation was chosen like optimal solution as a compromise between winter and summer needs.

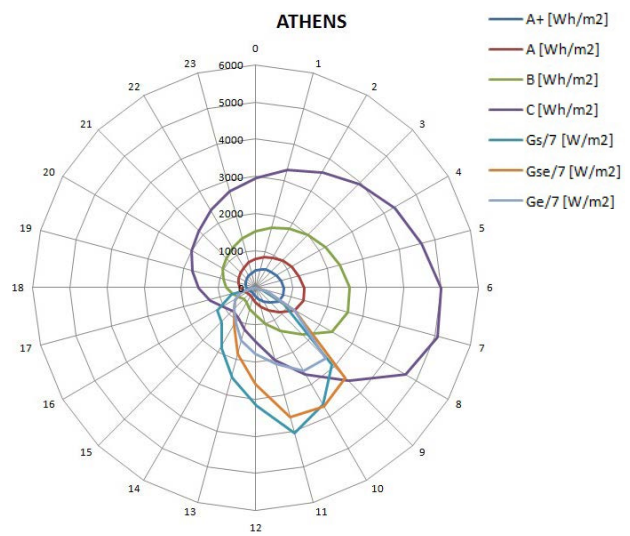

Figure 5. Radar-diagram with data from Meteonorm data bases for heat losses for different energy classes of facilities and Solar gains to different orientations for Athens [4].

ATHENS- Cooling Degree Hours  
Ta>26°C [Kh]

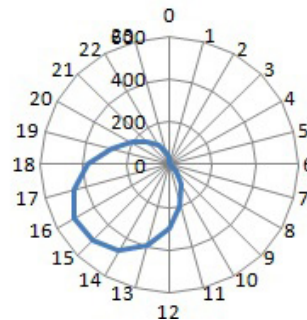

Figure 6. Radar-diagram with data from Meteonorm data bases for Cooling Degree Hours for Athens.

## The recommended Heating and Cooling system

For smaller construction facilities of neolepenism, radiator heating is not acceptable, because radiator heaters and pipes take up valuable living space. However, the author assumes that, primarily due to the non-orthogonal architecture, it might be best to use surface water heating/cooling systems placed in the building envelope. The wall heating/cooling water systems are the most attractive because it is possible use the same pipelines for all year around. Also, the vertical walls have rectangular forms.

Wall heating/cooling also allows the natural ventilation, which is important, because it prevents the spread of droplet infections from the ventilation and air conditioning systems (Legionnaires' disease, corona viruses ...). During the corona virus pandemic, the World Organizations and the Associations for Air Conditioning, Heating, Refrigeration and Ventilation (ASHRAE and REHVA) published instructions and conducted online seminars on handling and operation, primarily of ventilation and air conditioning systems in order to reduce the risk of covid-19 infection [6, 7]. Water heating systems were not in the center of attention in these documents.

Surface heating/cooling systems are low temperature: "in [5] it is stated that the water temperature during heating is a maximum of 45°C, and during cooling a minimum of 13°C. (...) They are ideal for combination with heat pumps as a source of energy. (...) Floor surfaces should be used primarily for heating, and ceiling surfaces primarily for cooling. Wall systems are used equally for heating and cooling."

For bigger construction facilities of neolepenism, low-temperature modes are also attractive for use in district heating/cooling, and even in district heating without cooling: absorption cooling machines or heat pumps that use solar energy for cooling can have solar panels on flat roofs of larger neolepenism buildings for their cooling application in the summer season, and during the winter part of the heat energy could be settled from district heating or the excess heat energy could be distributed through the hot water network to consumers who lack that energy. Optimization of these systems depends on specific locations and climatic conditions, and automatic regulation plays an important role. But, the statics of objects must be considered.

## Usage of flat roof

In low-energy buildings, as well as in the architecture of neolepenism, "the needs for heating/cooling are significantly reduced, but the needs for thermal energy for the preparation of domestic hot water (DHW) have remained at the same level, so that the needs for DHW become dominant [8]". The surface of the flat roof in neolepenism buildings can be used for the installation of solar thermal panels, both for heating purposes and for the preparation of DHW. During summer season solar thermal panels can be use for DHW or for cooling by heat pump.

The variant of the shape of the building of the architecture of neolepenism with a flat roof also enables the construction of a green roof (plant roof covering). This can be applied in order to reduce the heat load in summer. Also, for larger facilities, a green roof and the installation of solar panels, both photovoltaic and thermal, can be combined. It depends primarily on the wishes of investors.

It is necessary to take into account the orientation of solar panels. Their optimal orientation does not coincide with the optimal orientation of the building structure of neolepenism architecture, which is predominantly eastern. Solar panels in the Northern Hemisphere should be faced to the south.

## Conclusion

The author believes that the architecture of neolepenism, with its calculated and defined form, can be a passive means of protection that can affect global warming and climate change, since buildings are the largest consumers of energy and are largely responsible for greenhouse gas emissions. Space design can be one of the strategies for designing low-energy and passive buildings and that is the simplest strategy. The current practice assumes an object of arbitrary shape, where the problems of energy efficiency were solved by the increased use of thermal insulation and an active heating/cooling system.

The paper briefly describes the architecture of neolepenism with the original pictures of a model of a small family house of 62 m<sup>2</sup>. The shape of the building with flat roof of the architecture of neolepenism is internationally copyrighted by the World Intellectual Property Organization (WIPO) through the Intellectual Property Office of the Republic of Serbia as a type of industrial design in 2020.

In considering heating/cooling installations for neolepenism architecture, the author proposes the application of low-temperature surface systems, primarily wall heating/cooling, which would be installed mostly in the exterior walls of construction facilities. The author also believes that in some cases, such bigger buildings of neolepenism can use district heating as one of the types of active heating system.

The architecture of neolepenism represents a new Green technology with roots in the prehistoric culture of Lepenski Vir. Architects and engineers need to work together in integrated design to come up with practical solutions. Urban planning, architecture and district heating can represent a harmonious energy chain of energy production and consumption in the future. ■

## Bibliography

- [1] International Passive House Association, *Passive House Guidelines*, [https://passivehouse-international.org/index.php?page\\_id=80](https://passivehouse-international.org/index.php?page_id=80).
- [2] Chen, C. Julian, *Physics of Solar Energy*, Department of Applied Physics and Applied Mathematics Columbia University, John Wiley & Sons, Inc. New Jersey, USA, 2011, ISBN 978-0-470-64780-6.
- [3] Miloradović, Nenad, *Lepenski Vir – the prehistoric energy efficient architecture*, REHVA Journal, Vol. 5, 2016, pp. 55-59.
- [4] Miloradović, Nenad, *Neolepenism as a type of energy efficient architecture*, Proceedings of 50th Congress of KGH, SMEITS, 2019, [http://kgk-kongres.rs/images/2019/prezentacije/93\\_Nenad\\_Miloradovic.pdf](http://kgk-kongres.rs/images/2019/prezentacije/93_Nenad_Miloradovic.pdf).
- [5] Milinković, Srđan, *Sistemi površinskog grejanja i hlađenja (podno, zidno i plafonsko)*, Ekokuća, Vol. 5, 2012, pp. 57-58.
- [6] *ASHRAE Position Document on Infectious Aerosols*, Approved by ASHRAE Board of Directors April 14, 2020, [www.ashrae.org](http://www.ashrae.org).
- [7] REHVA COVID-19 guidance document, April 3, 2020, [www.rehva.eu](http://www.rehva.eu).
- [8] Corgnati, Stefano Paolo, *Promoting nZEB through Cost Optimality*, 47th Congress of KGH, Beograd, 2016, <http://kgk-kongres.rs/images/2016/doc/ppt/04-Corgnati.pdf>.
- [9] Srejić, Dragoslav, *Lepenski Vir, nova praistorijska kultura u Podunavlju*, SKZ, Beograd, 1969.

# Hygiene requirements

## for ventilation and air-conditioning systems

### REHVA EUROPEAN GUIDEBOOK No.9

After COVID-19 lockdowns and buildings reopening, it will be very important to comply with industry standards and the attention will have to be put on the cleanliness of the ventilation systems. REHVA Guidebook No. 9: Hygiene Requirement for Ventilation and Air Conditioning provides guidance on hygiene requirements for planning, installation, maintenance and operation and describes appropriate test procedures and test criteria for ventilation and air-conditioning systems and air-handling units.

This Guidebook applies to all ventilation and air-conditioning systems and air-handling units and their central or decentralised components which influence the quality of the supply air. It is intended to provide a holistic formulation of hygiene-related constructional, technical and organisational requirements supplementing current regulations, ISO-, EN-standards and VDI standards. This guidebook addresses all those involved in the planning, manufacture, execution, operation and maintenance of ventilating and air-conditioning systems.

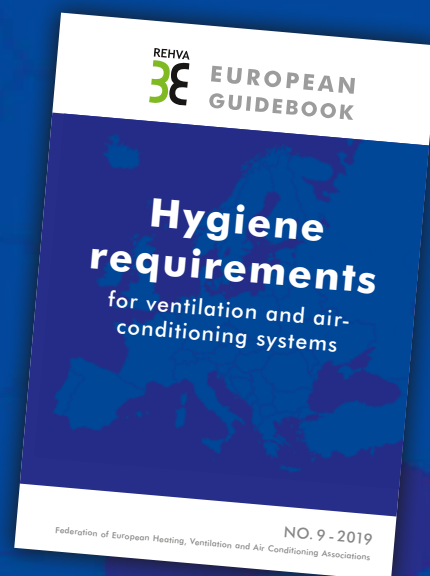



# H2020 MOBISTYLE project's showcase of the final results



**ANA TISOV**

Huygen Engineers and Consultants, Maastricht, The Netherlands  
a.tisov@huygen.net



**JURE VETRŠEK**

Institute for Innovation and Development of University of Ljubljana, Ljubljana, Slovenia  
jure.vetrsek@iri.uni-lj.si



**DAN PODJED**

Institute for Innovation and Development of University of Ljubljana, Ljubljana, Slovenia  
dan.podjed@iri.uni-lj.si



**PETER OP 'T VELD**

Huygen Engineers and Consultants, Maastricht, The Netherlands  
p.optveld@huygen.net

Especially in the times of pandemics, it is important that different building occupants are aware of the invisible correlation between indoor environmental quality (IEQ), personal health, human – building interaction and energy efficiency as through such established awareness, we can nudge new behaviours that can lead to a better well-being as more energy efficient buildings.

**Keywords:** Energy use, indoor environment, health, behaviour change, awareness campaign, people-centred approach.

This paper presents the final results of an interdisciplinary European H2020 project MOBISTYLE (MOtivating end-users Behavioural change by combined ICT based modular Information on energy use, indoor environment, health and lifestyle <https://www.mobistyle-project.eu/en/mobistyle/Pages/default.aspx>), designed to raise user awareness on importance of the correlation between indoor environmental quality,

personal health, well-being and buildings energy efficiency. Based on the 5 different demonstration cases covering different EU geographical areas, different building typologies (social housing, private homes, hotel, office, public university buildings) and different building user types, MOBISTYLE concluded that rationally modifying indoor environment can enhance people's lives as also helps the environment.

This project has received funding from the European Union's Horizon 2020 research and innovation programme under the grant agreement No 723032 (MOBISTYLE). The sole responsibility for the content of this paper lies with the authors. It does not necessarily reflect the opinion of the European Commission (EC). The EC is not responsible for any use that may be made of the information it contains.



## The MOBISTYLE approach

The aim of the 42-months long H2020 MOBISTYLE project (1st of Oct 2016 – 30th of Jun 2020) was to show that improving buildings and building technologies is not enough. In order to achieve ambitious goals of EU on energy savings in buildings, a different approach is needed where users of the buildings are equally important part of the building ecosystem as building technologies and building components characteristics. Therefore, the emphasis should be furthermore on educating users on how to use their buildings and how to increase their awareness by combined information on their energy usage, generated IEQ, health and lifestyle.

The MOBISTYLE approach is innovative in terms of providing mixed method research approach – complementation of quantitative and qualitative research. Such method provides a more complete and comprehensive understanding of the problem than using either quantitative or qualitative approaches alone. It provides an approach for developing more context specific instruments where the quantitative data (objective measurements through building's sensors) are supported with qualitative data (in depth analysis of occupants' behaviour through anthropological inquiries).

MOBISTYLE publications in two previous editions of REHVA Journals (Dec 2018 [1] and Oct 2019 [2]) introduced in the detail the MOBISTYLE objectives, the developed people-centred approach, behavioural action plans developed for the different demonstration sites as also technical details of the different developed MOBISTYLE ICT tools.

## MOBISTYLE Demonstration

To summarize, the monitoring of demonstration buildings in MOBISTYLE covered the following real-life environments:

1. A campus of university buildings, more specifically, four faculty buildings – Faculty for Economics (EF), Faculty for Arts (FF), Faculty of Computer Science and Informatics (FRI), and Faculty for Chemistry (FKKT) in Slovenia;
2. A hotel environment in Italy;
3. A complex of residential buildings in Denmark;
4. A housing district connected to an electricity grid in Poland;
5. Two open plan office buildings in the Netherlands.

To satisfy the building occupants and users' needs at the different demonstration sites, the following solutions were developed:

- The Dashboard as a tool for buildings energy and IEQ monitoring, with a suggestions system to guide users toward a more efficient behaviour. It had been tailored for the two identified user groups in non-residential buildings: building occupants (employees – using mobile app version) as managers of the buildings (experts – using PC version). It has been tested for the Slovenian and Italian demonstration case.
- The Game as a gamified app for behavioural change on efficient energy use and for awareness creation on the associated health benefits for residential cases. It has been tested for the Danish and Polish demonstration case.
- The Office App as a dashboard for office spaces in order to stimulate the dynamic indoor conditions acceptance and had been tested for the Dutch case.
- The Expert Tool allowed building managers (demonstration case holders) harmonized management of different data types as also offered easy to visualize features. The experts were able to filter the information they need, calculate pre-defined KPIs as also set up their own KPIs.

Four business and exploitation plans were developed to support the developed solutions.

## Demonstration cases results

### *Slovenian demonstration case:*

- Beside MOBISTYLE dashboard application, extensive building tailored awareness campaigns based on the people centred approach were organized at the university building in Ljubljana Slovenia, that included in app information and notifications based on measurements, frames on relevant locations in the building, regular messages on public screens and air quality information via non-intrusive LED changing colour in offices.
- Quantitative data, acquired with sensors, helped to identify behaviour patterns for each room individually and for the building as a whole. Slovenian case results showed example of “attitudinal fallacy”, where people either intentionally misrepresent their behaviour to make them look like they are adhering to the desired behaviour or their actions are simply too subconscious to report them accurately.
- Cooling usage was decreased even when the cooling degree days (the need for cooling) increased in all buildings (one faculty building for 13% and other

for 25% when comparing baseline and monitoring period when interventions took place).

- Heat use for heating was decreased in all buildings (gas consumption of FRI FKKT complex was reduced for 7%, district heat on EF for 12,4% and FF 9,1%) while heating degree days were decreased only for 5%.
- Personal elevators use was decreased in all cases (FKKT large -7,4%, FKKT small -13,2%, X -10,1%, FRI -14,6%. The 2 measured on EF: -32,6 and -4,3%).
- After the campaigns, the perception evaluation was done where people were confident that they understood how their actions affect the energy usage.

#### **Italian demonstration case:**

- Beside MOBISTYLE dashboard application, extensive awareness campaigns based on the people centred approach were organized especially for the hotel staff.
- MOBISTYLE stickers stressing on positive impacts on health of proper ventilation were successful. Stickers had a bigger impact than ICT-tools because they were easily visible without necessity to open an app (e.g. lower electricity consumption, lower CO<sub>2</sub>). Staff members stated that the scars interest for ICT-tools was mainly due the lack of their integration with other services.

#### **Danish demonstration case:**

- Danish demonstration case addressed the social housing residents in Aalborg. The MOBISTYLE Game was developed to combine information regarding IEQ and energy.
- The ICT tool application (Game) led to improved IEQ in many apartments but had no impact on energy use. Occupants felt more informed and became aware of the impact of their practices. In Danish case, the low saving could be due to the fact that MOBISTYLE demonstration covered already renovated NZEB apartments, where the actual saving after renovation was higher than expected. The energy use for heating was therefore much lower than most occupants were used to from previous apartments and from before renovation, so they already experience much lower energy cost, which may be an important part of the reason
- The ICT system had limitations leading to loss of interest on a longer run. It had been noted that the main improvement would be achieved through a reduction of data flow latency, in order to allow the user to receive immediate feedback from their

actions, and in ensuring a consistent and stable data flow from installed sensors (avoiding data loss).

#### **Polish demonstration case:**

- Polish demonstration case was aiming to achieve the behaviour change of the home occupants in Wroclaw, clients of Polish energy provider through an application of MOBISTYLE Game.
- Due to the boundary conditions of the project (innovation action) with limited resources, the project impact was not fully utilized due to limited number of data correlations leading to limited information provision.
- Most actions were related to improving IEQ (humidity and air temperature). Most building occupants remained within the 'healthy' boundaries of the different parameters. The game was treated more as an innovative gadget and not a system that actually could generate real changes in the use of particular devices and utility media consumption control. It seems that healthy home and gamification elements were the way to motivate people to become aware of the influence of their daily actions at home on the aspect of IEQ, however, these did not necessary lead to energy savings. To keep the interest on a long run, it seems the economic benefits should be made visible even if these benefits are small.
- Further Game development would be needed, having the ability to remotely control smart home devices, to compete with other smart home solutions available on the market.

#### **Dutch demonstration case:**

- Dutch case provided three studies to test whether dynamic indoor temperatures (compared to static) are acceptable. The hypothesis was that the dynamic temperatures can lead not only to improved metabolic and cardiac health but also lead to user's acceptance and comfort (see further research from the group of Professor Wouter van Marken Lichtenbelt from Maastricht University [3]).
- People found dynamic temperature profiles comfortable and the comfort levels were not significantly different from those of the stable temperatures. Despite the change in thermal sensation from slightly cool to slightly warm, the thermal comfort stayed within the limits of just comfortable and comfortable. The experiments for this case showed that dynamic conditions (moderate temperature drifts) do not lead to perceived thermal discomfort. The study indicated that metabolic healthy can be affected positively by dynamic indoor temperature

compared to fixed scenario without compromising thermal comfort.

- This is an important finding because it means that there is in fact no reason for stable control of the indoor climate. It was simulated that such dynamic campaigns can lead to average 21% energy saving compared to static conditions.
- MOBISTYLE Office App was developed for the Brightlands office building in the Netherlands to further increase occupant's acceptance of dynamic conditions satisfaction. The app also took into account occupants' satisfaction with IEQ through a simple feedback loop (voting feature).
- 85% of the office employees found the tool appealing where it educated the colleagues as office guests about the indoor conditions in the different meeting rooms as also provided feedback about potential benefits of the dynamic conditions. The experiments with wearables were part of this study.

### **MOBISTYLE Limitations**

It is important to keep in mind that results have some limitations:

**Statistical representativeness:** In MOBISTYLE the sample size was relatively small, which is typical for ethnographic research methods, where small samples are examined in detail to understand behaviour of actual people, not generic target groups. The MOBISTYLE approach is innovative in terms of providing mixed method approach – complementation of quantitative and qualitative research. Such method provides a more complete and comprehensive understanding of the problem than using either quantitative or qualitative approaches alone. It provides an approach for developing more context specific instruments where the quantitative data (objective measurements through building's sensors) are supported with qualitative data (in depth analysis of occupants' behaviour through ethnographic inquiries).

Large enough sample size would be crucial for obtaining statistically significant results, however, due to the project resources restrictions a large set-up of such detailed anthropological investigations was not possible. Furthermore, also limitations in the building sensing capacity were identified and therefore only the most important indoor environment and energy parameters could be measured.

**Uncertain variables:** Our daily behaviour is complex, interrelated and therefore it is difficult to isolate single parameters influencing our behaviour especially on the

long run. Studying 'soft factors' (also human factors) can therefore be more challenging than acknowledging the technological 'hard factors'. However, there lies a common understanding that without taking into account both, 'soft' as 'hard' factors, real energy efficiency cannot be met (in practice observed as performance gap). Also, effective occupancy was unknown for most of the cases due to the limitations in the building sensing capacity.

**Technical sensing limitation:** Several cases had missing data due to the problems with data acquisition, stability of data and capability of the system. The MOBISTYLE ICT system depended on several demonstration case related sub systems. Within the MOBISTYLE ICT system, data was acquired from the different sensing devices (existing, new cost-efficient) with the different communication protocols and data exchange requirements therefore interoperability between the different systems was an issue. Clearly, the complexity of the different demonstration cases data gathering was underestimated. The EE-07-2016-2017 encouraged the use of low-cost sensors where such sensors sometimes had a poor quality, leading to poor data flow stability.

**Rapid ICT developments:** Actual MOBISTYLE solutions deployment and demonstration was realized more than three years after the submission of the proposed project's work programme. With the fast developments in the ICT area in the recent years, there are many new solutions entering the market that could be more suitable for MOBISTYLE purposes.

### **MOBISTYLE Main lessons learnt and final conclusions**

MOBISTYLE project addressed different building typologies and different building user types. The project proved that it is not enough to only look at the raw sensorized building data (big data) where this data is needed to be correlated with the deeper insights into a case specific context and understanding of people's behaviour (thick data). This requires an interdisciplinary approach with wider understanding of the complexity and dependencies between people's behaviour, indoor environment – health, energy nexus.

Building use should be improved in order to ensure healthy, productive and comfortable living environments while using only necessary amount of energy. These aspects (introduced through innovative KPIs)

should be clearly visible to people, so they feel connected to their indoor environment and also to make them feel safe and relaxed, instead of overburdened with additional cognitive load; information and suggestions. Therefore, direct, dynamic, contextual and comprehensible feedback on energy consumption, indoor environmental quality (IEQ) and related health implications should be provided to people in a meaningful way in long term campaigns, since it assures constant improvements and changes of mindset on a longer run.

However, in this research project the monitoring results are based on a small sample and therefore are not sufficient for any statistical significance yet to come to validated quantitative recommendations. The monitoring results show that further investigation and especially large-scale monitoring campaigns, in combination with campaigns targeting behaviour, in different EU countries, would be useful, meaningful and necessary.

From data analysis, interpretation and personal communication, some relevant lessons can still be drawn about the effectiveness of MOBISTYLE-like behaviour campaigns:

- Energy efficient behaviour campaigns should not be seen as stand-alone solutions but should be part of the **community building** or **building facility management**. Various site specific (established) communication channels should be exploited for campaigns.

Location associated **micro cultural specifics** need to be taken in to account when designing campaigns.

- **Cost-effective and simple multi-channel campaigns** can be very effective where information has to be **contextualized** and **long lasting** without bringing additional cognitive load. Furthermore, it is important to **target decision makers** as people listen to well respected people they trust within their communities.
- **Accessible, minimalistic solutions and low budget measures** (e.g. stickers, LED lighting, temperature training campaign) can have more immediate impact than complex systems (i.e. ICT-tools), which require the users to be fully willing to start using them and needs to devote more time and cognitive capacity to them.
- **Reliable technology** must be a priority. If the technology has a bug, it is valuable to “humanize” or “anthropomorphize” it, e.g. devices “confess” that there was an error. In other case people will stop using the technologies as they will not trust it anymore.
- **Transparent and clear information** has to be given in order to avoid any risk of resistance, feeling of manipulation among targeted user groups.
- Behaviour in groups seems to follow **tipping point effect** (phase change) with only few at first where soon followed by almost everyone. Activities should be designed by approach focused on **communities**. Behaviour change is a long-lasting process where new behaviours are created with **small steps**. ■

## Partners:



## References

- [1] Tisov, A.; Veld, P.O. Introduction to the H2020 MOBISTYLE project, REHVA Journal, Dec 2018. URL – Available online: [https://www.mobistyle-project.eu/en/mobistyle/dissemination/PublishingImages/mobistyle-publications/REHVA\\_Dec%202018.pdf](https://www.mobistyle-project.eu/en/mobistyle/dissemination/PublishingImages/mobistyle-publications/REHVA_Dec%202018.pdf) (accessed on 20.07.2020).
- [2] Tisov, A.; Olivadese R.; Arabsolgar D.; Margoudi M. REHVA Journal, Oct 2019. URL – Available online: [https://www.mobistyle-project.eu/en/mobistyle/dissemination/PublishingImages/mobistyle-publications/REHVA\\_Oct\\_2019.pdf](https://www.mobistyle-project.eu/en/mobistyle/dissemination/PublishingImages/mobistyle-publications/REHVA_Oct_2019.pdf) (accessed on 20.07.2020).

Schellen, L., van Marken Lichtenbelt, W.D., Loomans, M.G., Toftum, J., de Wit, M.H. Differences between young adults and elderly in thermal comfort, productivity, and thermal physiology in response to a moderate temperature drift and a steady-state condition. *Indoor air*. 2010;20(4):273-83.



# REHVA COVID-19 guidance activities continue



## 3rd REHVA COVID-19 guidance published<sup>1</sup>

End of July, REHVA published the second review of its COVID-19 Guidance. The newest version of the guidance is focusing on how to reopen and safely use buildings after the lockdown and suggests mitigation measures on specific components and building types, including a document on [how to reopen schools](#)<sup>2</sup>, the [use of fan coils with recirculation](#)<sup>3</sup> and [minimising air-leakages across rotary heat exchangers](#).<sup>4</sup>

As a result of the intense advocacy by scientist around the world including several REHVA experts, WHO finally acknowledged in July the possibility of [airborne transmission](#)<sup>5</sup> especially in crowded, poorly ventilated spaces. With WHO turning course and the emerging evidence on SARS-CoV-2 airborne transmission, the general recognition of long-range aerosol route has developed and the awareness of the key role of ventilation in mitigating transmission risks in buildings increased. This has made ventilation measures the most important engineering control within infection control. While physical distancing is important to avoid a close contact, the risk of aerosol concentration and cross-infection from 1.5 m onward from an infected person can be reduced with adequate ventilation and effective air distribution solutions.

The scope of the third REHVA guidance is limited to commercial and public buildings (e.g., offices, schools, shopping areas, sports premises, etc.) where only occasional occupancy of infected persons is expected. The guidance is focused on temporary, easy-to-organise measures that can be implemented in existing buildings which are in use during or after an epidemic with normal or reduced occupancy rates. While there are many possibilities to improve ventilation solutions in the future, it is important to recognize that current technology and knowledge already allows the use of many rooms in buildings during a COVID-19 type of outbreak if ventilation meets existing standards and a risk assessment is conducted. The guidance document is developed in three main axes:

- (1) How to operate HVAC and other building services in existing buildings (right now during an epidemic)
- (2) How to conduct risk assessment and assess the safety in different buildings and rooms
- (3) Which far-reaching actions would ensure lower infection risk of viral diseases spread in future buildings

Every space and operation of building is unique and requires specific assessment, therefore REHVA lists 15 recommendations that can be applied in existing buildings at a relatively low cost to reduce the number of cross-infections indoors focusing on recommendations for ventilation solutions as the main 'engineering controls'.

## REHVA course in autumn: safe building operation during the COVID-19 pandemic

REHVA is developing an online course on How to operate buildings and safely use densely occupied spaces. This practical online course targets facility managers, occupational health and safety specialists, building service contractors and any building professional who is involved in the maintenance and operation of buildings, HVAC systems and the management of indoor climate quality. Participants who successfully take the exam, receive a certification.

The course will be based on the REHVA guidance, but the modules provide a deeper knowledge and hands-on practical information thought by REHVA experts. Participants get also the latest REHVA guidebooks that deal with air filtration and the hygiene requirements of ventilation systems along the following main modules:

- The science behind: COVID transmission, risk mitigation and the role of HVAC systems
- How to resume indoor activities and reopen public spaces & low-tech strategies to prevent airborne viral transmission

- How to use HVAC systems to prevent airborne viral transmission (ventilation, air filtration, purification, air-flow management, IAQ monitoring, etc.)
- Tailored practical guidelines to the use of densely occupied space and building types (i.e. office spaces, industrial facilities, schools, HoReCa, shopping malls, sport facilities, public transport, etc.)

[Pre-register](#) to the course and get all the information about the course first! (Use the QR-code →)



### REHVA COVID19 Task Force's work continues

The REHVA Task Force will continue its work on updating the guidance document with new information, including further guidance on the assessment of infection risk in indoor spaces linked to ventilation. On the long run, Task Force members consider focusing on the future aspects of ventilation systems and indoor air quality management that emerged because of this pandemic, developing new guidebooks on certain topics and technological solutions that can improve HVAC systems to make building safe in a similar epidemic situation. REHVA expresses its gratitude to the Task force members for their continued contribution and commitment. ■

### Summary of practical measures for building services operation during an epidemic

1. Provide **adequate ventilation** of spaces **with outdoor air**
2. Switch **ventilation on** at nominal speed at least **2 hours before** the building opening time and set it to **lower speed 2 hours after** the building usage time
3. **At nights and weekends**, do not switch ventilation off, but keep systems running at a **lower speed**
4. **Open windows regularly** (even in mechanically ventilated buildings)
5. **Keep** toilet ventilation in operation **24/7**
6. **Avoid open windows in toilets** to maintain the right direction of ventilation
7. Instruct building occupants to **flush** toilets with **closed lid**
8. Switch **air handling units** with recirculation to **100% outdoor air**
9. **Inspect** heat recovery equipment to be sure that **leakages** are under control
10. Adjust fan coil settings to operate so that **fans** are **continuously on**
11. **Do not change** heating, cooling and possible humidification setpoints
12. Carry out **scheduled duct cleaning** as normal (additional cleaning is not required)
13. **Replace** central outdoor air and extract **air filters** as normal, according to the maintenance schedule
14. Regular filter **replacement and maintenance** works shall be performed with common **protective measures** including respiratory protection
15. Introduce an **IAQ sensor network** that allows occupants and facility managers to **monitor** that **ventilation** is operating adequately.

[Download the new guidance](#)

(Use the QR-code →)



### Links

- 1 [https://www.rehva.eu/fileadmin/user\\_upload/REHVA\\_COVID-19\\_guidance\\_document\\_V3\\_03082020.pdf](https://www.rehva.eu/fileadmin/user_upload/REHVA_COVID-19_guidance_document_V3_03082020.pdf)
- 2 [https://www.rehva.eu/fileadmin/user\\_upload/REHVA\\_COVID-19\\_Guidance\\_School\\_Buildings.pdf](https://www.rehva.eu/fileadmin/user_upload/REHVA_COVID-19_Guidance_School_Buildings.pdf)
- 3 [https://www.rehva.eu/fileadmin/user\\_upload/REHVA\\_COVID-19\\_specific\\_guidance\\_document\\_-\\_Use\\_of\\_fan\\_coils\\_and\\_avoiding\\_recirculation\\_.pdf](https://www.rehva.eu/fileadmin/user_upload/REHVA_COVID-19_specific_guidance_document_-_Use_of_fan_coils_and_avoiding_recirculation_.pdf)
- 4 [https://www.rehva.eu/fileadmin/user\\_upload/REHVA\\_COVID-19\\_specific\\_guidance\\_document\\_-\\_Limiting\\_internal\\_air\\_leakages\\_across\\_the\\_rotary\\_heat\\_exchanger\\_.pdf](https://www.rehva.eu/fileadmin/user_upload/REHVA_COVID-19_specific_guidance_document_-_Limiting_internal_air_leakages_across_the_rotary_heat_exchanger_.pdf)
- 5 <https://www.rehva.eu/news/article/who-acknowledge-emerging-evidence-of-airborne-spread-of-covid-19>

# MEMBERS



Network of 26 European HVAC Associations  
 joining 120 000 professionals

REHVA Office: Rue Washington 40, 1050 Brussels - Belgium

Tel: + 32 2 514 11 71 - info@rehva.eu - www.rehva.eu



# SUPPORTERS

## LEADERS IN BUILDING SERVICES



Network of 26 European HVAC Associations  
 joining 120 000 professionals

REHVA Office: Rue Washington 40, 1050 Brussels - Belgium

Tel: + 32 2 514 11 71 - info@rehva.eu - www.rehva.eu



Send information of your event to Ms Giulia Marengi [gm@rehva.eu](mailto:gm@rehva.eu)



# Exhibitions, Conferences and Seminars in 2020 & 2021

## Conferences and seminars 2020

|                 |                                      |                     |   |
|-----------------|--------------------------------------|---------------------|---|
| 1 September     | Danvak Dagen 2020                    | Copenhagen, Denmark | <a href="https://danvak.dk/produkt/danvakdagen2020/">https://danvak.dk/produkt/danvakdagen2020/</a>   |
| 6-9 September   | NSB 2020 Building Physics Conference | Tallinn, Estonia    | <a href="http://www.nsb2020.org/">www.nsb2020.org/</a>  |
| 14-15 September | CIBSE Symposium                      | Glasgow, UK         | <a href="https://www.cibse.org/technical-symposium-2020">https://www.cibse.org/technical-symposium-2020</a>                                 |
| 13-14 October   | BuildSim Nordic 2020                 | Oslo, Norway        | <a href="https://buildsimnordic2020.ibpsa-nordic.org/">https://buildsimnordic2020.ibpsa-nordic.org/</a>                                     |
| 13-15 October   | Chillventa 2020                      | Nurnberg, Germany   | <a href="https://www.chillventa.de/en">https://www.chillventa.de/en</a>   |
| 29-31 October   | Refcold                              | Delhi, India        | <a href="https://www.refcoldindia.com/home">https://www.refcoldindia.com/home</a>   |
| 1-5 November    | Indoor Air 2020                      | Seoul, Korea        | <a href="http://www.indoorair2020.org">www.indoorair2020.org</a>  |
| 4-6 November    | Brussels Summit                      | Brussels, Belgium   | <a href="https://www.rehva.eu/events/details/rehva-brussels-summit-2020">https://www.rehva.eu/events/details/rehva-brussels-summit-2020</a> |

## Conferences and seminars 2021

|                 |  |                  |   |
|-----------------|--|------------------|---|
| 10-12 January   | Climamed   | Lisbon, Portugal | <a href="http://www.climamed.org/en/">http://www.climamed.org/en/</a>   |
| 23-27 January   | 2021 ASHRAE Winter Conference & AHR Expo                                     | Chicago, IL, USA | <a href="https://www.ashrae.org/conferences/2021-winter-conference-chicago">https://www.ashrae.org/conferences/2021-winter-conference-chicago</a>             |
| 14-17 February  | Roomvent 2020  | Torino, Italy    | <a href="http://roomvent2020.org/">http://roomvent2020.org/</a>   |
| 17-21 April     | Cold Climate   | Tallin, Estonia  | <a href="https://www.scanvac.eu/events.html">https://www.scanvac.eu/events.html</a>   |
| 26-29 April     | 13th IEA Heat Pump Conference  | Jeju, Korea      | <a href="http://hpc2020.org/">http://hpc2020.org/</a>   |
| 15-18 August    | 13th International Industrial Ventilation Conference for Contaminant Control | Toronto, Canada  | <a href="https://www.ashrae.org/conferences/topical-conferences/ventilation-2021">https://www.ashrae.org/conferences/topical-conferences/ventilation-2021</a> |
| 29 Sept - 2 Oct | ISK Sodex 2021   | Istanbul, Turkey | <a href="http://www.sodex.com.tr/">http://www.sodex.com.tr/</a>   |



**Due to the COVID19 circumstances, the dates of events might change. Please follow the event's official website.**





In many European countries ventilation of school buildings is a challenge. In times of COVID-19, the importance of a good indoor air quality is once more emphasized.

## TRANSMISSION ROUTES

#1

via **microdroplets** staying **airborne** for hours and can be **transported** long distances



#2

via **droplets** (when sneezing, coughing or talking)



#3

via **surface contact** (hand-hand, hand-surface etc.)



#4

via the **faecal-oral** route

## VENTILATION

Secure ventilation of spaces **with outdoor air**



Switch **air handling units** with central recirculation to 100% outdoor air



Ensure CO<sub>2</sub>-controlled ventilation runs **at maximum capacity** during occupancy

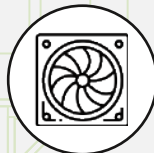

Switch on **ventilation** at least **2 hours before & after** occupancy



Install a **CO<sub>2</sub> monitor** with traffic light indication



**Instruct teachers & staff** on proper use of ventilation facilities



**Open windows as much as possible** during school hours & ensure airing during breaks



**Keep** toilet ventilation **24/7** in operation and/or keep **windows open**

## SANITARY FACILITIES



Instructions to **flush** toilets with **closed lid**

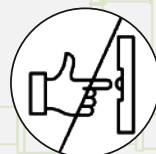

**Install water taps** with sensor for no touch use



All water taps must be in **operating condition** with facilities to disinfect hands



**Flush** all toilets, water taps and showers **frequently**



Ensure that **floor drains do not run dry** to avoid open connection to the sewer

For further information see the [REHVA COVID-19 guidance on schools](#) document and [REHVA COVID-19 Guidance page](#).

**Disclaimer:** This infographic is to be used for informational purposes only and is not intended to replace the advice of authorities or medical professionals. REHVA excludes any liability for any direct, indirect, incidental damages or any other damages that would result from or be connected with these of the information presented in this document. © 2020 REHVA All Rights Reserved

# EUROPEAN GUIDEBOOKS



**No.01: DISPLACEMENT VENTILATION IN NON-INDUSTRIAL PREMISES**



**No.02: VENTILATION EFFECTIVENESS**



**No.03: ELECTROSTATIC PRECIPITATORS FOR INDUSTRIAL APPLICATIONS**



**No.04: VENTILATION AND SMOKING**



**No.05: CHILLED BEAM APPLICATION GUIDEBOOK**

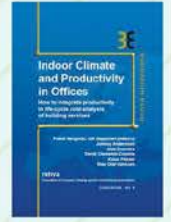

**No.06: INDOOR CLIMATE AND PRODUCTIVITY IN OFFICES**



**No.07: LOW TEMPERATURE HEATING AND HIGH TEMPERATURE COOLING**



**No.08: CLEANLINESS OF VENTILATION SYSTEM**



**No.09: HYGIENE REQUIREMENTS FOR VENTILATION AND AIR-CONDITIONING SYSTEMS**

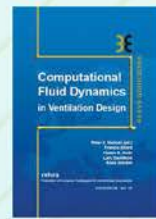

**No.10: COMPUTATIONAL FLUID DYNAMICS IN VENTILATION DESIGN**



**No.11: AIR FILTRATION IN HVAC SYSTEMS**



**No.12: SOLAR SHADING**

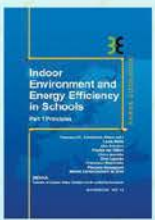

**No.13: INDOOR ENVIRONMENT AND ENERGY EFFICIENCY IN SCHOOLS - PART 1**



**No.14: INDOOR CLIMATE QUALITY ASSESSMENT**



**No.15: ENERGY EFFICIENT HEATING AND VENTILATION OF LARGE HALLS**



**No.16: HVAC IN SUSTAINABLE OFFICE BUILDINGS**



**No.17: DESIGN OF ENERGY EFFICIENT VENTILATION AND AIR-CONDITIONING SYSTEMS**

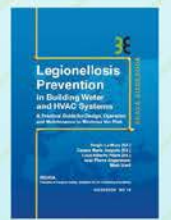

**No.18: LEGIONELLOSIS PREVENTION IN BUILDING WATER AND HVAC SYSTEMS**



**No.19: MIXING VENTILATION**



**No.20: ADVANCED SYSTEM DESIGN AND OPERATION OF GEOTABS BUILDINGS**



**No.21: ACTIVE AND PASSIVE BEAM APPLICATION DESIGN GUIDE**



**No.22: INTRODUCTION TO BUILDING AUTOMATION, CONTROLS AND TECHNICAL BUILDING MANAGEMENT**



**No.23: DISPLACEMENT VENTILATION**



**No.24: FIRE SAFETY IN BUILDINGS**



**No.25: RESIDENTIAL HEAT RECOVERY VENTILATION**

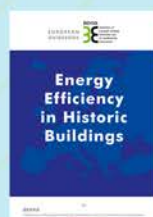

**No.26: ENERGY EFFICIENCY IN HISTORIC BUILDINGS**

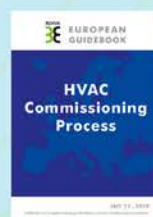

**No.27: HVAC COMMISSIONING PROCESS (REHVA-ISHRAE)**



**No.28: NZEB DESIGN STRATEGIES FOR RESIDENTIAL BUILDINGS IN MEDITERRANEAN REGIONS**



**No.29: QUALITY MANAGEMENT FOR BUILDINGS**