

The REHVA European HVAC Journal

Special issue for ACREX India 2019 exhibition

**Energy, Smart building
technology and Indoor
Environmental Quality are
common grounds**

PAGE 4

**Development of
Psychrometric diagram for
the energy efficiency of
Air Handling Units**

PAGE 5

**On the history of indoor
environment and it's relation
to health and wellbeings**

PAGE 13

**CEN Standard
EN 16798-3:2017 on
ventilation for non-residential
buildings: PERFORMANCE
REQUIREMENTS**

PAGE 20

**Certified commissioning of
new & existing buildings**

PAGE 34





YOU DON'T WANT TO LIVE IN A WORLD
WITHOUT THIRD-PARTY CERTIFICATION.

ENJOY PEACE OF MIND AND CHOOSE PRODUCTS SIMPLY AND SECURELY

We promise you **TRANSPARENCY, INTEGRITY, INDEPENDENCE, IMPARTIALITY**. Our robust certification process includes : continuous verification, product sampling, independent tests conducted by accredited laboratories and agencies, selection software checks and independent assessment.

Since 1994 EUROVENT CERTITA CERTIFICATION certifies the performance ratings of HVAC-R products for residential home and industrial facilities.

Getty Images ©sturti



Download your customized certified solution on :
www.eurovent-certification.com

Editor-in-Chief: Jaap Hogeling
 jh@rehva.eu

Associate Editor: Stefano Corgnati, Italy
 stefano.corgnati@polito.it

Editorial Assistant: Rebeka Maršnjak,
 rm@rehva.eu

General Executive: Ismail Ceyhan, Turkey

REHVA BOARD

President: Stefano Corgnati

Vice Presidents:

- Atze Boerstra
- Frank Hovorka
- Jarek Kurnitski
- Milos Lain
- Catalin Lungu
- Manuel Carlos Gameiro da Silva

EDITORIAL BOARD - 2019

- Francis Allard, France
- Ahmet Arisoy, Turkey
- Marianna Brodatch, Russia
- Vincenc Butala, Slovenia
- Stefano P. Corgnati, Italy
- Francesca R. d'Ambrosio, Italy
- Ioan Silviu Dobosi, Romania
- Andy Ford, United Kingdom
- Jaap Hogeling, the Netherlands
- Karel Kabele, Czech Republic
- Jarek Kurnitski, Estonia
- Livio Mazzarella, Italy
- Renato Merati, Italy
- Birgit Müller, Germany
- Natasa Nord, Norway
- Branimir Pavkovic, Croatia
- Dusan Petras, Slovakia
- Olli Seppänen, Finland
- Branislav Todorovic, Serbia
- Peter Wouters, Belgium

ADVERTISEMENTS

Giulia Marengi, gm@rehva.eu

**SUBSCRIPTIONS and
 CHANGES OF ADDRESSES**

REHVA OFFICE:
 Washington Street 40
 1050 Brussels, Belgium
 Tel: 32-2-5141171, Fax: 32-2-5129062
 info@rehva.eu, www.rehva.eu

PUBLISHER

Color Dots Press Studio 208, DSIDC Shed,
 Okhla Industrial Area, Phase-I
 New Delhi 110020

REHVA Journal is distributed in over 50 countries through the Member Associations and other institutions. The views expressed in the Journal are not necessarily those of REHVA or its members. REHVA will not be under any liability whatsoever in respect of contributed articles.

Cover Photo by Rutger Lanser on Unsplash

Contents

Download the articles from www.rehva.eu -> REHVA Journal

EDITORIAL

- 4** Energy, Smart building technology and Indoor Environmental Quality are common grounds
 Jaap Hogeling

ARTICLES

- 5** Development of Psychrometric diagram for the energy efficiency of Air Handling Units
 Kiyan Vadoudi & Sandrine Marinhas
- 13** On the history of indoor environment and it's relation to health and wellbeing
 Lada Hensen Centnerová
- 20** CEN Standard EN 16798-3:2017 on ventilation for non-residential buildings: PERFORMANCE REQUIREMENTS
 Livio Mazzarella & Jaap Hogeling
- 27** Energy efficiency of Remote Refrigerated Display Cabinets beyond the implementation of the Ecodesign and Energy Labelling Directives
 Kiyan Vadoudi, Dan Bibalou & Sandrine Marinhas
- 34** Certified commissioning of new & existing buildings
 Ryan Cormac
- 37** Ventilation Ductwork Systems Certification for a Better Air Tightness
 Marie-Clémence Briffaud
- 42** Certifying the Fan Performance in Air Handling Units with a Wire-to-Air approach
 Marie-Clémence Briffaud

- 47** Have your say on EPB standards' roll-out and join the practitioner's community!
 Jaap Hogeling, Dick van Dijk & Anita Derjanecz
- 50** Quality Management and Digitalization for Building Performance
 Stefan Plesser & Ole Teisen

PRODUCT CERTIFICATION

- 57** European Certification of HVAC&R products
 Erick Melquiond
- 60** Certification Programmes for domestic, commercial and industrial facilities

EVENTS & FAIRS IN 2019

- 81** Exhibitions, Conferences and seminars in 2019
- 82** REHVA is attending Futurebuild: join us in London
- 83** REHVA-ISHRAE Seminar on "High Performance Educational Buildings and their Indoor Environmental Quality" at ACREX 2019
- 84** REHVA-ISHRAE workshops
- 87** ISH 2019: the world's leading trade fair focusing on the responsible management of water and energy in buildings
- 89** REHVA 13th HVAC WORLD CONGRESS
- 91** The first set of CLIMA 2019 Workshops announced!

Advertisers

- ✓ EUROVENT 2
- ✓ REHVA Supporters & Members 95
- ✓ REHVA Guidebooks 96

REHVA Journal

REHVA Journal is a technical, practical journal for the HVAC industry professionals. It is read by Designers, Consultants, Manufacturers, Investors, Mechanical Contractors, Sales and Representative Companies, Architects Energy sector's professionals, governmental institutions authorities, etc.

Energy, Smart building technology and Indoor Environmental Quality are common grounds

The ACREX special of the REHVA Journal is a great opportunity to contact the ISHRAE professional community. REHVA welcomes this opportunity to share ideas and technical issues.

Energy, Indoor Environmental Quality and Quality Assurance/Commissioning are common focus points we share. In this editorial we want to share information on these issues, about actions and policies developing in Europe.

We communicated in 2018 about the set of Energy Performance Buildings standards that have been published in Europe (as European standards) and globally (as ISO standards in the 52000 series). A reference to this set of EPB standards can be found at www.epb.center. These EPB standards are currently being implemented in Europe. The use of this set of harmonised, transparent and unambiguous energy performance assessment procedures, as laid down in these standards, will stimulate innovation on energy using products and services in Europe and even beyond. REHVA welcomes cooperation and sharing the experience with the use of these EPB standards with the ISHRAE professional community (Please see article about EPB Center on page 47).

Additional to this standardisation work in Europe, the important concept of smart building technology is now developing. A smart building is a building which is highly energy efficient and covers its very low energy demand by on-site or district-system-driven renewable energy



JAAP HOGELING
Editor-in-Chief
REHVA Journal

sources. Smart building technology stabilises and drives a faster decarbonisation of the energy system through energy storage and demand-side flexibility. Smart building technology empowers its users and occupants with control over the energy flows and recognises and reacts to user and occupant needs in terms of comfort, health, indoor air quality, safety, as well as operational requirements.

Indoor environmental quality is an urgent issue worldwide. Poor buildings and poorly designed or maintained building HVAC systems and improper energy saving measures in buildings jeopardise our indoor environment. Poor outdoor air quality, as more and more occurring in dense populated areas, will require us to clean our buildings air intake carefully. Being able to identify these adverse indoor environmental quality issues using simple but reliable measurement equipment, will motivate building users/owners to act to improve their situation. Reliable sensor technology will support the building user to take the correct actions and have great potential to achieve our IEQ targets. These issues are as important in Europe as in India. Cooperation in this field is expected to be beneficial for all building users around the globe, from simple housing situations to complex buildings and work environments. ■

Development of Psychrometric diagram for the energy efficiency of Air Handling Units



KIYAN VADOUDI

Eurovent Certita Certification
50 Rue de la Victoire
Paris, France
k.vadoudi@eurovent-certification.com



SANDRINE MARINHAS

Eurovent Certita Certification
50 Rue de la Victoire
Paris, France

Air Handling Unit (AHU), as a system for space heating and cooling is one of the most relevant causes of energy consumption in both residential and tertiary sector buildings. As the energy efficiency of AHU is closely linked to the climate conditions, a special attention should be given about varying yearly climate conditions in different geographical locations. This paper presents an approach for calculating the energy efficiency by using the Psychrometric diagram which has been divided into five zones based on different functions of AHU; for each zone outside climatic has a particular status with yearly weight that is corresponds for specific AHU's operation. To achieve this, different combination of outdoor climatic parameters (Dry and wet bulb temperature and humidity ratio) has been considered as varieties for defining zones. Sum of AHU's energy consumption in different zones based on related weighting factor will result in the total annual consumption of energy.

Keywords: Air Handling Units (AHU), Energy efficiency, Psychrometric diagram

The residential buildings represent about 40% - 50% of the total energy consumption and the major part of this consumption is used for Air Handling Units (AHU) to prepare the thermal comfort (Council 2013). The amount of required energy depends on outdoor condition fluctuations, interaction between natural gravity and air tightness of the building, heat exchangers, efficiency of other equipment, and operation modes of AHU systems (Misevičiūtė et al. 2017). Fans, heat exchangers and heaters as the main

elements that use energy in AHU, have a significant effect on both energy needs of a building and the energy efficiency of a system. AHU's energy consumption can be calculated in two ways. In the case of working air handling units the actual consumption data can be exactly determined by measurement. But according to Directive 2002/91/EC (Union 2009) on the energy performance of buildings (EPBD) it is also important to determine the expected energy consumption in the designing phase. However, the calculation of the energy

consumption of air handling units is still problematic, especially when the climate condition differs.

The energy efficiency of AHU system is closely linked to geographical location (Trojanova et al. 2009), especially to the outdoor climatic parameters such as dry bulb temperature, wet bulb temperature, relative humidity and enthalpy. But, there is too little attention paid to the evaluation of the exact climate that is the core in AHU application and related energy analysis. Therefore, there is a need to investigate methods that are being used to climatic parameters in relation to AHU operation. This paper aims at demonstrating the application of the different climatic parameters for the evaluation AHU’s energy consumption. Special attention is given to the proposition of Psychrometric diagram for AHU based on different operations and calculating the yearly energy efficiency based on it.

Psychrometric diagram

An important pioneer of thermal comfort representations was Victor Olgyay, who introduced the “Bioclimatic Chart” (Olgyay, 1963). However, the thermal comfort area reported in his chart was not consistent with ASHRAE 55 thermal comfort areas. Givoni, partially converted the Olgyay’s representation to the psychrometric chart (Figure 1) and added rules about passive heating and cooling strategies (Givoni, 1969).

The application of Givoni’s psychrometric chart in energy efficiency of air conditioning is studied in some studies. Zhang and Niu studied the applicability of heat and moisture recovery systems in Hong Kong by classifying the psychrometric chart into six regions based on outdoor temperature and humidity (Zhang and Niu 2001). Mohammad Rasouli, proposed different scenarios for Energy Recovery Ventilators (ERV)’s function, whether it should be operated or stopped depends on several factors such as, the indoor and outdoor conditions by dividing the psychrometric chart into sub-regions that establish the conditions when the ERV needs to be controlled (Rasouli, Simonson, and Besant 2010). In other study, Stefano Schiavon presented a new web application (Schiavon, Hoyt, and Piccioli 2014) for thermal comfort visualization and calculation according to ASHRAE Standard 55-2013 (ASHRAE 2013). Simonson et al. experimentally validated two strategies to control energy wheels by applying an operating condition factor which presented the ratio of latent to sensible energy potential of inlet airstreams (Simonson and Besant 1999). Since use of this methodology is investigated for the operational efficiency of air conditioning systems and buildings energy efficiency, the use of this chart could also be useful in energy efficiency calculation of AHU.

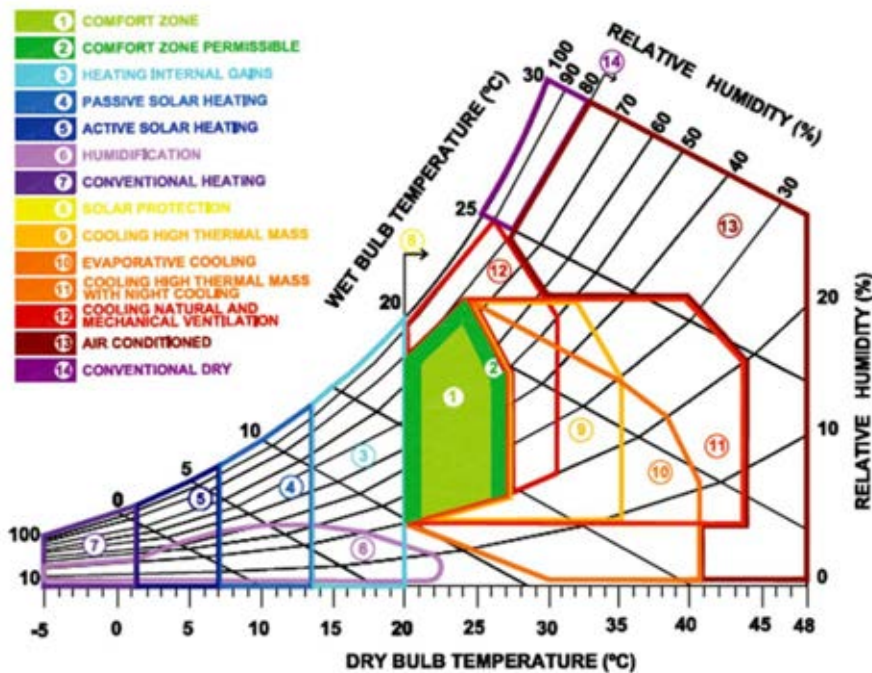

Figure 1. Psychrometric chart (Givoni 1992).

AHU energy efficiency

The treatment of the air in AHU requires different types of energy, depending on the utilized systems and components which causes specific operation (Eurovent, 2005):

Heating: By means of thermal energy (heat exchangers fed with hot water) or by means of electrical energy (electrical heat exchangers). In addition, electrical energy is demanded to run the utilized pumps.

Cooling: By means of cooling systems based on compression cycles using electrical energy for running the system, or based on absorption cycles using thermal energy for operating the absorption cycle process or based on evaporation processes like adiabatic cooling. In addition, electrical energy is demanded to run the utilized pumps.

Humidification: By water (evaporation humidification) or vapor (steam humidification). In case of steam humidification, thermal energy is required for the generation of the steam. In case of evaporation humidification, electrical energy is demanded to run the injection pumps. Evaporation heat is withdrawn from the passing air (thermal energy).

Dehumidification: The delivery air stream after passing the heat or humidity recovery unit is cooled in the cooling coil to the dew point temperature and then the additional cooling power for dehumidification is calculated.

Ventilation: In AHU air is transported by means of fans, using electrical energy.

Auxiliary devices: To operate AHU properly, a number of auxiliary devices such as damper motors, control equipment, lighting systems and pumps are needed. All of these devices require electrical energy.

Therefore, the overall demand of energy for AHU can be summarized into two classes of electrical energy and thermal energy. A realistic indication of energy efficiency over an entire year can be achieved by using Coefficient of Performance (COP) which indicates on how efficient AHU operates over an entire cooling or heating season (Ertesvåg 2011). A ratio of the thermal capacity is in watts and the electricity input values is in watts.

$$\text{COP} = Q/P \quad (1)$$

Q = Useful heat supplied or removed by the considered system (W).

P = Work (electricity) required by the considered system (W).

The COP is therefore a measurement of efficiency; the higher the number, the more efficient the system is. The COP is dimensionless because the input power and output power are measured in Watt. The COP is also an instantaneous measurement in that the units are power which can be measured at one point in time.

Electrical energy calculation

In our calculation, we only consider the fan's electrical consumption. The absorbed power supplied from the mains to each individual fan can be expressed as follows ((EU) No 327/2011):

$$P_{el} = q_v \cdot \Delta p_{fan} / \eta_e \cdot 1000 \quad (2)$$

P_{el} = Absorbed electrical power supplied from the mains (W)

q_v = Air volume flow through the fan (m³/s)

Δp_{fan} = Total pressure rise from the fan inlet to the outlet (Pa)

P_{shaft} = Mechanical power supplied to the fan shaft (W)

η_e = Overall efficiency of the fan and motor system
= $\eta_{shaft} \cdot \eta_{tr} \cdot \eta_m \cdot \eta_{aceq}$

All values are applicable to an air density of $\rho_{air} = 1.2 \text{ kg/m}^3$

Thermal energy calculation

The thermal energy consumption of a sensible heating/cooling coil and heat exchanger is calculated with the equation (Eurovent, 2005):

$$Q_s = q_v \cdot \rho \cdot c_p \cdot (t_{out} - t_{in}) \quad (3)$$

Q_s = Sensible energy consumption

q_v = Air flow rate in m³/s

ρ = Density of the considered air flow rate in kg/m³ = 1.2 kg/m³

c_p = Specific heat of the air in kJ/kg·K = 1.00 kJ/(kg·K)

t_{out} = Temperature of the air leaving the coil in °C

t_{in} = Temperature of the air entering the coil in °C

The momentary thermal energy consumption for sensible cooling/heating of air when the moisture of air changing is calculated with the equation:

$$Q_s = q_v \cdot \rho \cdot (h_{in} - h_{out}) \quad (4)$$

Q_s = Sensible energy consumption when the moisture of air changing

q_v = air flow rate in m³/s

ρ = density of the considered air flow rate in kg/m³ =

$$1.2 \text{ kg/m}^3$$

h_{in} = enthalpy of the air at the inlet of the coil in kJ/kg

h_{out} = enthalpy of the air at the outlet of the coil in kJ/kg

The momentary energy consumption for latent heating/cooling coil and heat exchanger (dehumidification/humidification of air in a cooling coil) is established with the formula (Eurovent, 2005):

$$Q_l = q_v \cdot \rho \cdot (x_{in} - x_{out}) \cdot 2500 \quad (5)$$

Q_l = Latent energy consumption

q_v = Air flow rate in m³/s

ρ = Density of the considered air flow rate in kg/m³ = 1.2 kg/m³

x_{in} = Moisture content of the air at the inlet of the coil in kg/kg

x_{out} = Moisture content of the air at the outlet of the coil in kg/kg

2500 = Condensation (evaporation) heat of water vapor at moderate coil outlet temperatures in kJ/kg

Total thermal energy (Q_t) consumption of a cooling/heating coil is the sum of the energy consumption for sensible and latent cooling/heating (Eurovent, 2005). Hence:

$$Q_t = Q_l + Q_s \quad (6)$$

Methodology

The distribution functions of outdoor air parameters can be applied for determine the actual energy consumption of AHU (Kajtár and Vörös 2007). Temperature is commonly used as the thermal comfort control objective in early HVAC systems. But, temperature alone does not ensure a person's thermal comfort (Kajtár and Kassai 2010). From the perspective of air conditioning technology, the climatic parameters of outdoor air (Dry bulb temperature, Wet bulb temperature, humidity ratio, relative humidity and enthalpy) that vary in daily and season period (Kazuhiro 2005.), could couple with each other for effective planning and operation. However, it is difficult to control factors when each has its own strict set point.

An air handling unit contains two main groups of elements: supply and exhaust units. The main parts of these groups are including filter, heat recovery unit, cooling and heating coils, by-pass, adiabatic humidifier and fans, which based on different climatic conditions could conclude different operations; ventilation, cooling, cooling and humidification, cooling and dehumidification, heating and heating and humidification. Calculations of these parameters are really complicated by variable efficiency operation of air handling units due to fluctuation of outdoor condition (Kajtár and Kassai 2010). Therefore, calculating the energy efficiency based on different scenarios regarding the operational conditions of AHU could simplify the process. These different scenarios are presented by dividing the psychrometric chart into five sub-zones (**Figure 2**).

By selecting the summer indoor comfort condition as a reference condition (Comfort Zone, **Figure 2**), the psychrometric chart can be divided into five areas based on the temperature and humidity ratio. For thermal energy calculation, the center of comfort zone (Dry bulb temperature 22°C and 50% relative humidity) is selected as a reference indoor condition. The area with higher outdoor temperature and humidity ratio than the comfort zone (Zone 1) corresponds to yearly horses that AHU should operate as cooling and dehumidification, the area with higher temperature and same humidity ratio (Zone 2) that needs cooling and the area with higher temperature and less humidity ratio (Zone 5) that should be cooled and humidified. Furthermore, the area with lower outdoor temperatures than the comfort zone can be also divided into two zones: heating (Zone 3), heating and humidification (Zone 4).

$$GCOP = \sum_{i=1}^6 COP_i W_i \quad (7)$$

GCOP = Geographical Coefficient of Performance

COP_i = COP of each zones

W_i = Weight of each zone

Therefore, based on the function of AHU in each zones, COP, could differ. Multiplying COP of each zone with weight of hourly data over an entire year results Geographical COP (Equation 7) that is a new way of measuring the true energy efficiency of AHU. This new measure gives a more realistic indication of the energy efficiency and environmental impact of a system.

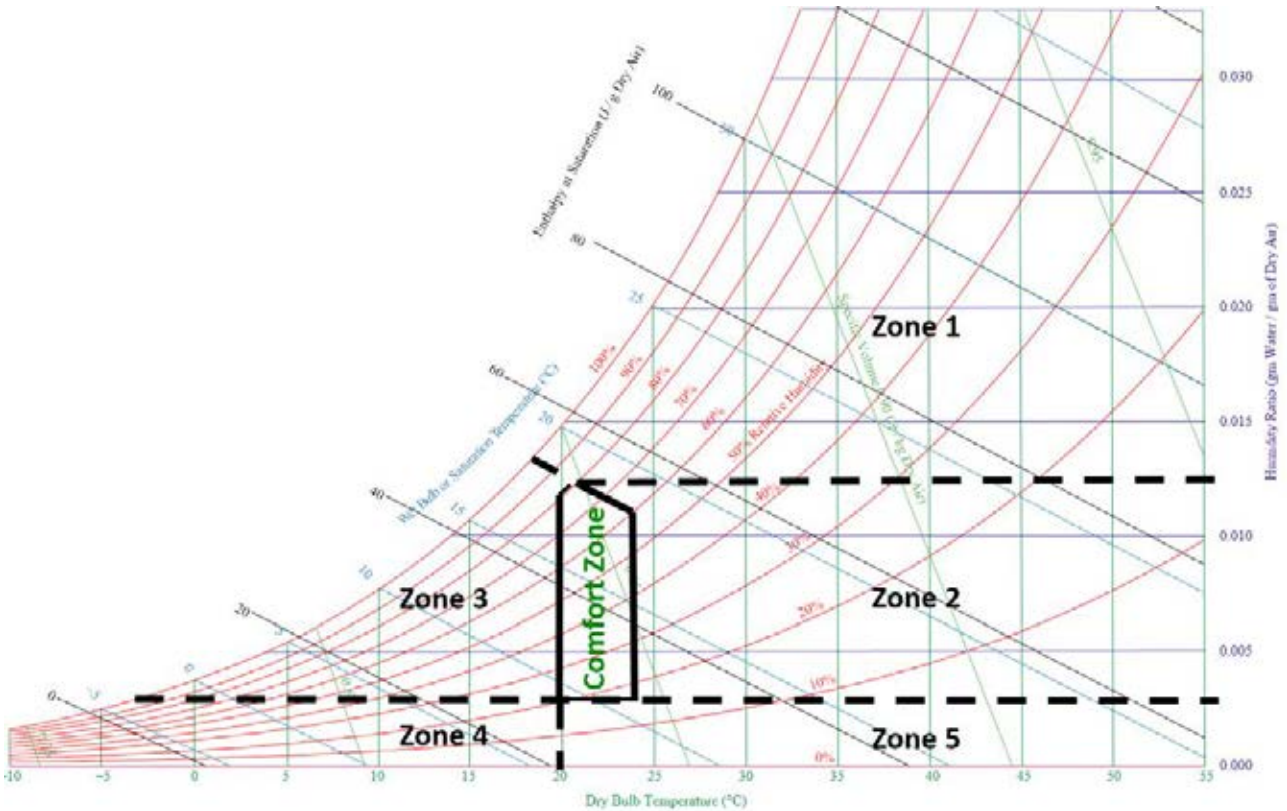

Figure 2. Climatic zones based on AHU's function.

Energy efficiency calculation

Zone 1; Cooling – Dehumidification (Humidity ratio ≥ 13 [g/kg], Wet Bulb ≥ 18.5°C)

When air is cooled below the dew point temperature, condensation occurs and moisture is removed from the air stream. The exiting air stream is at a lower temperature and humidity ratio than the incoming air stream. The cooling to condense water from the air is called latent cooling or dehumidification. Thus, the movement of a dot from this zone to comfort zone includes both sensible and latent cooling.

$$COP_{Z1} = [(Q_{CC} + Q_{DHU} + Q_{HRS}) / P_{el}] \cdot W_1 = [(Eq.3 + Eq.5 + Eq.4) / Eq.2] \cdot W_1 \tag{8}$$

Q_{CC} = Cooling coil thermal energy
 Q_{DH} = Dehumidification thermal energy

Zone 2; Cooling (Humidity ratio < 13 [g/kg], Humidity ratio ≥ 3 [g/kg], Dry Bulb ≥ 24°C)

On a psychrometric chart, the exiting air is at a lower temperature than the incoming air while the humidity

ratio remains constant since no moisture is condensed from the air. Reducing the temperature of air without changing the quantity of water in the air is called sensible cooling. The movement of a dot from this zone to comfort zone is possible by sensible cooling.

$$COP_{Z2} = [(Q_{CC} + Q_{HRS}) / P_{el}] \cdot W_2 = [(Eq.3 + Eq.4) / Eq.2] \cdot W_2 \tag{9}$$

Zone 3; Heating (Humidity ratio ≤ 13 [g/kg], Humidity ratio ≥ 3 [g/kg], Dry Bulb < 20°C)

In HVAC systems, air is typically heated by passing it over a heating coil or use of electrical strip heaters. A schematic of a cooling coil is shown below. Since the humidity ratio remains unchanged, and so we use a horizontal line on the psychrometric chart to represent this process. Heating will result in lower relative humidity.

$$COP_{Z3} = [(Q_{HC} + Q_{HRS}) / (P_{el} + P_{Aux})] \cdot W_3 = [(Eq.3 + Eq.4) / (Eq.2 + P_{Aux})] \cdot W_3 \tag{10}$$

P_{Aux} = Electrical energy consumption for heating coil (In case of using electrical heater)

Zone 4; Heating – Humidification (Humidity ratio < 3 [g/kg], Dry Bulb < 20°C)

Heating and Humidifying is the process of simultaneously increasing both the dry-bulb temperature and humidity ratio of the air. The total heat gained (Q) in going from the initial to the final condition can be broken into sensible and latent heat portions. The humidity ratio is constant for the horizontal movement (sensible) and the dry-bulb temperature is constant for the vertical movement (latent). Humidification process is done by humidifiers that can be classified to; steam or water and/or depending on the principle of operation. For heating, in case of using electricity, P_{Aux} adds to electrical energy calculation.

$$COP_{Z4} = [(Q_{HC} + Q_{HU} + Q_{HRS}) / (P_{el} + P_{Aux})] \cdot W_4 = [(Eq.3 + Eq.5 + Eq.4) / (Eq.2 + P_{Aux})] \cdot W_4 \quad (11)$$

Q_{HU} = Humidification thermal energy
 P_{Aux} = Electrical energy consumption for humidification (In case of using electrical steamer)

Zone 5; Cooling – Humidification (Humidity ratio < 3 [g/kg], Dry Bulb ≥ 20°C)

Cooling and Humidifying is the process of decreasing the dry-bulb temperature and increasing humidity ratio of the air. The total heat gained (Q) in going from the

initial to the final condition can be broken into sensible and latent cooling portions.

$$COP_{Z5} = [(Q_{CC} + Q_{HU} + Q_{HRS}) / (Eq.2 + P_{Aux})] \cdot W_5 = [(Eq.3 + Eq.5 + Eq.4) / (Eq.2 + P_{Aux})] \cdot W_5 \quad (12)$$

Calculation of COP for each zone and sum of them together conclude a specific SCOP for each geographical location, which is a base for AHU's energy efficiency. The much specific AHU's COP closer to GCOP, the more it is efficient. Case study by analyzing five different geographical location is proposed in the next section to present the concept in real case.

Case study

For plotting the hourly climatic data during a year for each geographical location, there are three tools that perform thermal comfort calculations, two of which are also able to visualize comfort conditions: Climate Consultant (Milne 2016), Autodesk Ecotect Weather Tool and the ASHRAE Thermal Comfort Tool. In this paper, Climate Consultant is chosen that is an excellent graphics-based, free, stand-alone computer program that helps users understand weather data used for building performance software. The program reads a weather file and presents a summary of the weather

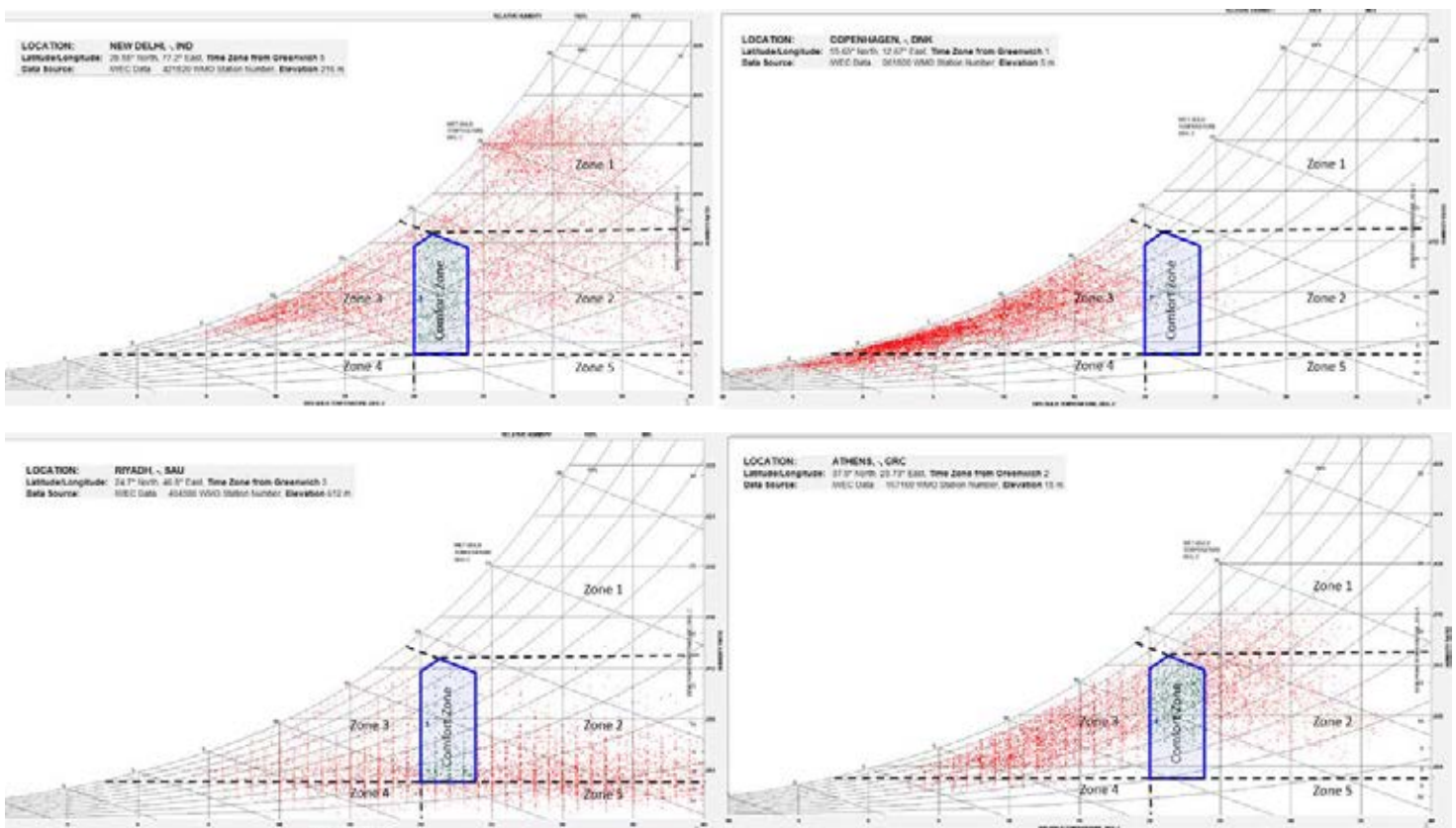

Figure 3. Psychrometric chart with zones based on AHU's function.

data as an overview of the selected climate, where each dot represents the temperature and humidity for each hour of the year. It uses standardized weather data for energy simulation software. To have a diverse climatic situation, Copenhagen, Athens, New Delhi and Riyadh are chosen for GCOP calculation.

The yearly climatic data for each city is extracted from Energy Plus website and imported to Climate Consultant 6.0 software to illustrate the data on psychrometric chart. Based on yearly data for each city, the percentage of hourly spots for each zone is calculated and presented in **Table 1**.

The next step of methodology is to calculate the COP of each zones for each city, in order to find the GCOP for AHU. Due to the limits of pages for submission process, we have chosen one city (Riyadh) to show the rest of

calculation. A certified AHU with energy grade A+, which is certified by Eurovent Certita Certification is chosen as the case. The data related with thermal energy calculation and electrical energy consumptions are obtained from performance calculation software. The software calculates in and out air temperature, temperature ratio, pressure drops, the fans capacity and electrical consumption and electrical consumptions of other devises. We conclude the example by calculating the COP_i , using the above equations, summarized in **Table 2**. The supply and exhaust airflows are assumed 9000 m³/h.

$$\begin{aligned} \text{GCOP} &= \\ &38 \cdot 0.23\% + 31.33 \cdot 40.49\% + 16 \cdot 21.93\% + \\ &10.22 \cdot 7.15\% + 15.33 \cdot 22\% = \\ &0.088 + 12.68 + 3.51 + 0.73 + 3.37 = 20.38 \end{aligned}$$

Table 1. Zone weights for different cities.

City	Zone 1	Zone 2	Zone 3	Zone 4	Zone 5	Comfort Zone
Riyadh	0.23%	40.49%	21.93%	7.15%	22.00%	8.22%
New Delhi	36.69%	23.32%	29.43%	0%	0.16%	10.41%
Athens	6.27%	19.52%	57.52%	1.83%	0%	14.87%
Copenhagen	0.13%	0.58%	85.52%	11.12%	0%	2.66%

Table 2. Output of software and calculation results based on above equations.

Symbol	Value
$Q_{CC} = Q_S$	31 kW
$Q_{HC} = Q_S$	28 kW
$Q_{HRS} = Q_S$ (Moisture change) – Summer	63 kW
$Q_{HRS} = Q_S$ (Moisture change) – Winter	20 kW
$Q_{HU} = Q_1$	44 kW
$Q_{DHU} = Q_1$	20 kW
P_{el}	3 kW
$P_{Humidification}$	6 kW
COP_{Z1}	$(31+20+63)/3 = 38$
COP_{Z2}	$(31+63)/3 = 31.33$
COP_{Z3}	$(28+20)/3 = 16$
COP_{Z4}	$(28+44+20)/(3+6) = 10.22$
COP_{Z5}	$(31+44+63)/(3+6) = 15.33$

This amount of GCOP with some tolerances could be a reference number for energy efficiency of AHU that are going to use in Riyadh and other cities with similar climatic condition.

Conclusions

The result of dividing yearly energy consumption of AHU based on different operations for climatic zones, was studied in this paper. The objective was to propose a methodology for both warm and cold climates with different humidity rates. This methodology results a number which could be used as

an index for energy efficiency of AHU is different climatic situations.

Due to the complexity of AHU's function and climatic parameters, the methodology needs improvements in terms of zones definition, AHU criteria such as unbalanced air flows and different case design and including wet bulb temperature in some equations. This study will continue with promoting zones, in order to have precise simulation for function of AHU. Moreover, a performance factor will add to GCOP formula to include different functional parameters in future studies. ■

References

- ASHRAE Standard. (2013). "Standard 55-2013." *Thermal Environmental Conditions for Human Occupancy* 12.
- Carey J. S., and Robert W. B. (1999). "Energy Wheel Effectiveness: Part II—correlations." *International Journal of Heat and Mass Transfer* 42(12):2171–85.
- Council, U. S. Green Building. (2013). *LEED Reference Guide for Building Design and Construction*. US Green Building Council.
- Commission Regulation (EU) No 327/2011. (2011) implementing Directive 2009/125/EC of the European Parliament and of the Council with regard to ecodesign requirements for fans.
- Eurovent. (2005). «Recommendations for calculations of energy consumption for air handling units». 6/8, Eurovent/Cecomaf.
- Ertesvåg, Ivar S. (2011). "Uncertainties in Heat-Pump Coefficient of Performance (COP) and Exergy Efficiency Based on Standardized Testing." *Energy and Buildings* 43(8):1937–46.
- Givoni, B. n.d. "A.(1969) Man, Climate and Architecture."
- Givoni, Baruch. (1992). "Comfort, Climate Analysis and Building Design Guidelines." *Energy and Buildings* 18(1):11–23.
- Kajtár, L. and Miklós K. (2010). "Energy Consumption of Air Handling Units." Pp. 37–39 in *Clima 2010–10th REHVA World Congress*.
- Kajtár, L. and Szilárd V. (2007). "Influence of Climate Change on Modelling of HVAC Systems." Pp. 232–35 in *Proceedings of the 2nd IASME/WSEAS international conference on Energy and environment*. World Scientific and Engineering Academy and Society.
- Kazuhiro, F. (2005). "Prediction of Energy Consumption by Using Weather Data, IASME." in *WSEAS International Conference on Energy, Environment, Ecosystems and sustainable development*.
- Koroleva, A. (2012). "Efficiency of Heat Recovery Units in Ventilation.", Master thesis.
- Milne, M. (2016). "Climate Consultant v6.0."
- Misevičiūtė, V., Kęstutis V., Violeta M., and Genrika R. (2017). "Analysis of Exergy Demand for Air Heating of an Air Handling Unit." *Energy Efficiency* 10(4):989–98.
- Olgay, V. (2015). *Design with Climate: Bioclimatic Approach to Architectural Regionalism*. Princeton University Press.
- Rasouli, M., Carey J. S., and Robert W. B. (2010). "Applicability and Optimum Control Strategy of Energy Recovery Ventilators in Different Climatic Conditions." *Energy and Buildings* 42(9):1376–85.
- Schiavon, S., Tyler H., and Alberto P. (2014). "Web Application for Thermal Comfort Visualization and Calculation According to ASHRAE Standard 55." Pp. 321–34 in *Building Simulation*, vol. 7. Springer.
- Trojanova, J., Jiri V., Karel M., J. R., and Petr S. (2009). "Fault Diagnosis of Air Handling Units." *IFAC Proceedings Volumes* 42(8):366–71.
- Union, Europäische. (2009). "Directive 2009/28/EC of the European Parliament and of the Council of 23 April 2009 on the Promotion of the Use of Energy from Renewable Sources and Amending and Subsequently Repealing Directives 2001/77/EC and 2003/30/EC." *Official Journal of the European Union* 5:2009.
- Zhang, L. Z. and J. L. Niu. (2001). "Energy Requirements for Conditioning Fresh Air and the Long-Term Savings with a Membrane-Based Energy Recovery Ventilator in Hong Kong." *Energy* 26(2):119–35.
- <http://www.eurovent-certification.com/index.php?lg=en>.
- <https://energyplus.net/weather>.

On the history of indoor environment and it's relation to health and wellbeing

This article describes research and developments in the past that had influence on how people thought and now think about indoor environment. The emphasis is on indoor air quality and thermal comfort.

Keywords: Indoor Environment, Thermal Comfort, Indoor Air Quality, History

From ancient times until the 18th century

Thermal Comfort - Heating

The history of indoor environment begins 1,5 million years ago when early humans began using campfires. At some point the campfire was brought inside caves and huts. The oldest arrangement was a central fire and a central roof opening for smoke to escape. Later the fire was moved to different parts of a dwelling and various schemes were tried to improve the efficiency of the fire by using stones. However, even the best open fire was only 20% efficient considering that most of the heat escaped with the smoke. Open fireplace heating was used as early as the 800s BC and became widespread across Europe by the 13th century. Romans already had underfloor heating to make the indoor climate in their palaces and spas comfortable (**Figure 1**). The next important advance in heating which had influence on thermal comfort was the invention of the chimney in the 15th century. It took the next 200 years to be widely adopted. The first freestanding warm air stoves were produced in the 17th century.[1]

Indoor Air Quality - Ventilation

Throughout history, man understood that polluted air could be harmful to health. Greeks and Romans were aware of the adverse effects of polluted air in, e.g., crowded cities and mines (Hippocrates, 460–377 BC). Throughout the medieval era, small steps forward have been done in this field. Bad air was held responsible for the spread of diseases and for the unpleasant sensa-



LADA HENSEN CENTNEROVÁ

Ing. PhD., Eindhoven University of Technology, The Netherlands,
l.hensen@tue.nl

tions that were experienced in poorly ventilated rooms. Around 1700, the general idea was that breathing was primarily a way of cooling the heart. But it was also common knowledge that expired air was unfit for breathing until it had been refreshed. [2]

The role of oxygen in breathing was pointed out by Lavoisier (1781), even though Boyle (1627–1691), and Hooke (1635–1703) 100 years earlier (1667) had found that the supply of air to the lungs was essential for life. The work of **Antoine Lavoisier** (1743–1794) was especially important for understanding the human metabolism, including the quantitative association between oxygen consumption and carbon dioxide (CO₂) release. During the following half century it was accepted that the concentration of CO₂ was a measure of whether the air was fresh or stale. [2]

19th century

Indoor Air Quality - Ventilation

In 1853 **Max J. Pettenkofer** (1818–1901) – the first professor in hygiene in Munich – noted that the unpleasant sensations of stale air were not due merely to warmth or humidity or CO₂ or oxygen deficiency, but rather to the presence of trace quantities of organic material exhaled from the skin and the lungs. He stated that ‘bad’ indoor air did not necessarily make people sick but that such air weakened the human resistance against agents causing illness. In Pettenkofer’s view CO₂ was not important but was an indicator of the

amount of other noxious substances produced by man. Pettenkofer stated that air was not fit for breathing if the CO₂ concentration (with man as the source) was above 1000 ppm and that good indoor air in rooms where people stay for a long time should not exceed 700 ppm, in order to keep the people comfortable. [2]

The first estimate of the required minimum amount of ventilation air was published in 1836 by a Cornish mining engineer Thomas Tredgold. He calculated that one person needed 2 l/s of fresh air for breathing and candle burning. [3]

ASHRAE recommended in 1895 as a minimum rate for ventilation 15 l/s per person. This ventilation rate was based on the work of John Billings (1836-1913), medical doctor and the American authority in the field of ventilation at that time.

For several centuries, there were two schools of thought with respect to ventilation. Architects and engineers were concerned with providing comfort, absence of noxious odors and carbon dioxide accumulation. Physicians, on the other hand, were concerned with minimizing the spread of disease. [3]

Indoor Air Quality & Thermal Comfort

Possibly the most complete overview of the relationship between indoor environment & health had **Florence Nightingale** (1820–1910). According to Wikipedia she was ‘an English social reformer and statistician, and the founder of modern nursing’. According to Chris Iddon she was ‘nurse & structural engineer’ [4]. Nightingale (**Figure 2**) wrote the first modern handbook for the nursing of sick ‘Notes on Nursing, What It Is, and What It Is Not’ [5]. In her foreword she wrote that her book was meant as ‘tips for women who are personally responsible for the health of others’.

The first chapter of her book focuses not on patient care, but on ventilation. She wrote: ‘The first task of nursing: to keep the air that breathes the patient as pure as the outside air, without cooling them.’ In the second chapter she



Figure 2. Florence Nightingale.



Figure 1. The Hypocaustum. Remains system of underfloor heating.

mentioned five essential points to ensure the health of houses:

- Pure air
- Clear water
- Efficient waste water drainage
- Hygiene
- Light

Nightingale has seen and approached the problems of the indoor environment in its entirety. Other recommendations from her, which are being rediscovered today, are:

- Bring air from outside. Open your windows and close your doors.
- (Natural) air temperature fluctuations are necessary to stay healthy.
- Light is essential for both health and recovery.
- The body and mind degenerate without sunlight.

In the beginning, thinking about the indoor environment was in the realm of philosophy. Much later, in the 19th century, indoor environment concerns were covered by two separate disciplines: medicine and engineering.

20th century

In the 20th century researchers were increasingly convinced that ventilation is mainly a matter of comfort and not of health. There was a growing resistance to heating the large amounts of outside air prescribed for ventilation.

Air Conditioning – Thermal Comfort

The beginning of the 20th century marks also the birth of air-conditioning, an invention that turned out to have a major impact on the indoor environment. Probably the first building with cooling (without using ice) is the Stock Exchange building in New York, USA. **Alfred Wolff** (1859–1909) designed the cooling system that used three ammonia absorption chillers, with a cooling capacity of 1,582 kW [6]. Yet he did not become the best-known air-conditioning engineer.

Willis H. Carrier (1876–1950) is known as the inventor (or father) of modern air-conditioning. Carrier designed his first system in 1902 to control temperature and humidity in a printing plant in Brooklyn (New York, USA). Unfortunately, this system did not work well and the design conditions couldn't be maintained. However, this design is generally marked as the first application of

air-conditioning. Since then, air-conditioning has been defined as a system that must have four basic functions:

- Temperature regulation
- Humidity control
- Air circulation and/or ventilation
- Air purification (filtration)

Carrier designed in 1904 a spray-type air-conditioner, a very sophisticated air washer, with which he could control the absolute humidity of the air leaving the conditioner and, ultimately, the relative humidity of the conditioned space. In January 1906, he obtained the patent called 'Apparatus for Treating Air' [7]. (The term 'air-conditioning' was first coined by the American textile engineer Stuart Cramer).

In 1911 Carrier presented his 'Rationale Psychrometric Formulae' at a meeting of ASHRAE. This became the basis for the fundamental calculations in the air-conditioning industry. His work helps to determine the precise relationship between temperature and humidity in order to be able to regulate the indoor climate throughout the year. With his scientific work, his vision of a new industry – air-conditioning - and with his entrepreneurial activities, Carrier has had a very strong influence on the indoor environment field (**Figure 3**). However, he was never really involved in comfort-related issues.



Figure 3. An example of air conditioning industry.

Indoor Air Quality

Leonard Hill (1866–1952) dedicated his life and work to research improving the physical well-being of people. He didn't find any evidence that high concentrations of CO₂ can cause discomfort and, therefore, he concluded that heat and odor (caused by physical emissions) are the main sources of uneasiness in rooms with poor ventilation [8].

Using an instrument known as the ‘kata thermometer’, he determined the cooling capacity of air movement on the human body. This was used to monitor workplace conditions in the United Kingdom, including the House of Commons, where Hill was concerned that ‘cold feet and stuffy heads result - just the wrong conditions for legislators’ [9].

In 1923, ASHRAE Journal published the article ‘Determination of the comfort zone’ (Houghten & Yaglou) [10], in which the conditions for comfort were presented on a psychrometric diagram. They used the index ‘Effective Temperature’ (ET), which was used extensively over the next 50 years [11]. ET is defined as the dry bulb temperature (DBT) of a uniform environment with a relative air humidity of 50%, which would have the same heat exchange, by radiation, convection and evaporation, as the environment in question (Figure 4).

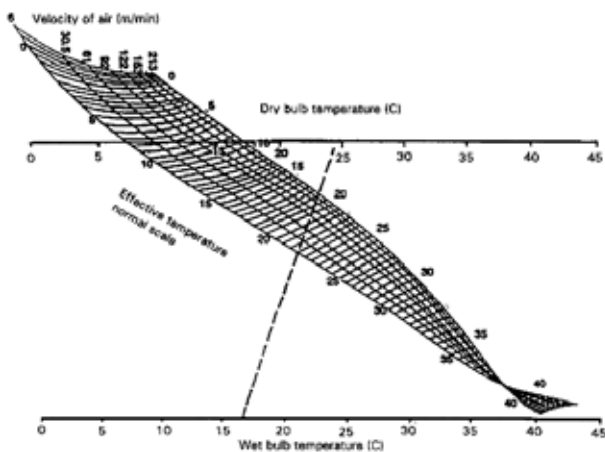

Figure 4. Effective Temperature nomogram (Yaglou).

Constantin Yaglou¹ (1897–1960) also studied the relationship between body odor and ventilation flow. He concluded that these odors are not really harmful to building users and that CO₂ concentration cannot be a good indicator of the air quality in buildings. Yaglou noted that odors are probably related to temperature and humidity [12]. Ventilation requirements were measured by using the human nose as a sensor.

In 1936 ASHRAE recommended 7.5 l/s per person on the basis of work of C. Yaglou.

¹ Yaglou’s original name was Yagloglou but in 1947 he shortened his surname.

Thermal Comfort

Adolf P. Gagge (1908-1993) introduced his ‘Two-node model’ in 1936. It calculates the thermal response by means of two energy balance equations, one for the core node and one for the skin node. This model (sometimes called Pierce model because Gagge made it together with his colleagues at JB Pierce Laboratories of Yale University) assumes that the sum of the heat exchange between humans and their environment through metabolism, activity, evaporation, radiation and conduction is zero. [13] With his model Gagge applied the first law of thermodynamics (conservation of energy) on man and his environment. [14] This model was expanded later (after World War II).

Gagge’s work helped define the study area of energy exchange between the human body and the immediate environment. It’s application had an impact on health and safety at work, in the military, in space exploration and in the design and operation of buildings [14].

From the early 1960s there were many researchers working in the field of thermal comfort. The most well-known and influential was **Povl Ole Fanger** (1934–2006). Fanger (Figure 5) focused on the relationship between the physical parameters of the environment, the physiological parameters of people and the perception of comfort expressed by people themselves. In 1970, he published his dissertation ‘Thermal Comfort’ [15] in which he defined a new discipline: the study of the condition of comfort and well-being in indoor environments. [14] The conceptual leap introduced by Fanger, compared to previous studies, is the introduction of the judgment scale by people themselves.

Using Fanger’s comfort theory, it is possible to predict to what extent a certain indoor environment will be experienced by building users as ‘cold’, ‘neutral’ or ‘warm’. The prediction of the mean thermal sensation, which is



Figure 5. P. O. Fanger.

associated with a combination of six environmental and personal parameters (air temperature, mean-radiant temperature, relative humidity, air velocity, activity level and thermal resistance of the clothing), is given as ‘Predicted Mean Vote’ (PMV-index). The PMV-index indicates the predicted opinion of a group of people with identical metabolism and clothing regarding their thermal sensation. It does not predict the acceptability of the environmental conditions (Table 1). As a follow-up to the PMV-index, Fanger introduced the PPD-index (Predicted Percentage of Dissatisfied) that does predict the acceptability (Figure 6). Fanger’s model was developed for the applications in air-conditioned buildings but, from the 1980s, it was also used for other applications (non-air-conditioned rooms). In other words, the interpretation of Fanger’s work in practice is not entirely correct [16].

Table 1. Scale of the PMV index.
[Source: NEN-EN-ISO 7730]

+3	Hot
+2	Warm
+1	Slightly warm
0	Neutral
-1	Slightly cool
-2	Cool
-3	Cold

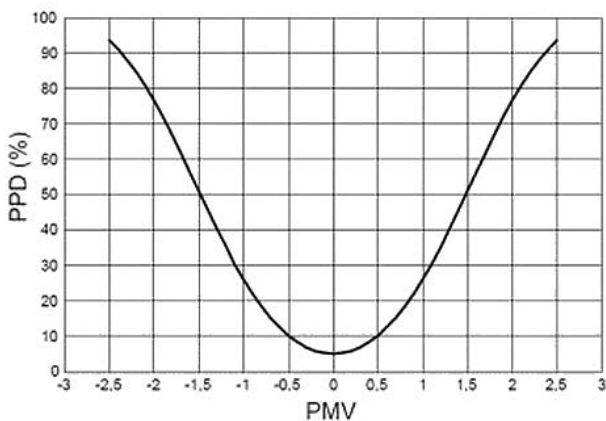

Figure 6. The relationship between PMV and PPD (Fanger)

Environmental movement

Environmental aspects largely focused on indoor air quality until the 1960s. In 1962, **Rachel L. Carson** (1907–1964) wrote her book ‘Silent Spring’. In this book she describes the harmful effects of pesticides on the environment. It is widely credited with helping launch the environmental movement. Environment was suddenly synonymous with outside air and industrial environment. Environmental protection received worldwide attention but IAQ (indoor air quality) in non-industrial indoor environments was not on the list of environmental problems.

In 1973, ASHRAE published its first Standard 62 with the recommended amount of supplied air of 7.5 l/s per person.

In 1981, ASHRAE divided the recommended amount of fresh supply air into two categories. For non-smoking rooms 2 l/s per person and for rooms where smoking was allowed 10 l/s per person.

Many different studies have shown that indoor air quality is influenced by the quantity and quality of the supplied fresh air, pollution by people themselves and emissions of the materials used in buildings. More and more specific studies have been carried out with regards to radon, tobacco smoke, VOC (volatile organic compounds), formaldehyde, (fine) dust, asbestos, dust mites and other agents that influence the indoor air quality.

Sick Building Syndrome

With the amount of fresh supply air minimized to 2 l/s per person (as a result of the energy crisis in the 1970s), there were more and more problems with the indoor environment, especially in office buildings (Figure 7). Many different terms were used to indicate the phenomenon of reported high occurrences of health problems and diseases. From 1982, the World Health Organization (WHO) used the term Sick Building Syndrome (SBS) and this became the most commonly used term. SBS relates to a number of symptoms that are experienced by several building occupants when they are in a building and which reduce or disappear completely when they leave the building. Since 1989, Healthy Buildings congresses have been organized to bring researchers from medical sciences together with engineers and technicians from practice to solve the problems that cause SBS.

A major challenge is that research and practice mostly focus on individual components. It is only during

ASHRAE Ventilation Rate History

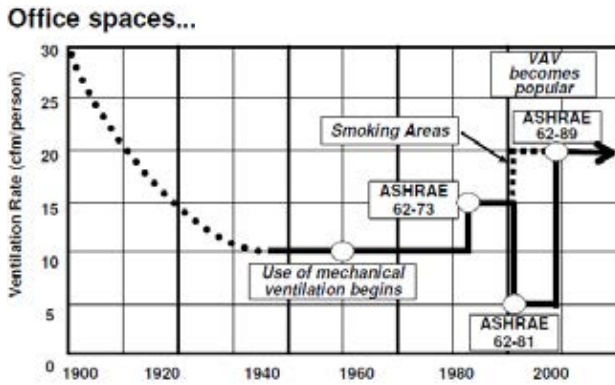

Figure 7. The overview of the recommended amount of air supply in ASHARE standards (Source: Olesen, 2011: PowerPoint-How much ventilation and how to ventilate in the future)

the last decades of the twentieth century that the first attempts towards more holistic approaches to indoor environmental problems were made [17]. With the holistic approach of the indoor environment, ‘soft’ factors are also taken into account. After the decades in which medical doctors and engineers had investigated the problem separately, these disciplines began to learn from each other. In the research on Sick Building Syndrome many psychological studies were conducted which focused on the perception of people. Many buildings are designed in a way that does not connect with evolutionary old ‘software’ in our brain; i.e., the basic laws that govern our behavior. [18] The relevant laws are:

- People and animals need change. This applies in particular to thermal comfort. A homogeneous environment means that people feel less comfortable.
- Man wants to constantly intervene in his environment. This law also applies mainly to the thermal comfort but also to ergonomics (furniture).
- A meaning must be given to stimuli. For example, a smell that is present in the building and that cannot be recognized, leads to a state of chronic alarm.
- Man always strives to have his own territory. This becomes a problem, for example, in open plan offices.
- Man has been living in artifacts for only several centuries and this has broken his contact with the natural environment. That’s why the view to outside is very important. [18]

Thermal Adaptation

The 1980s saw the start of the discussion about adaptive principles related to thermal comfort. The initiator was **Michael A. Humphreys**. An English physicist who does a lot of research into thermal adaptation of building occupants. In 1998, he wrote together with **J. Fergus Nicol**, an article ‘Understanding the Adaptive Approach to Thermal Comfort [19]. The starting point of their discussion was: ‘If a change occurs such as to produce discomfort, people react in way that tend to restore their comfort’. They explain adaptation as ‘all those physiological, psychological, social, technological, cultural, or behavioral strategies people might use to try to secure their comfort’. Some other researchers confine the term adaptation to that kind of physiological or psychological acclimatization through which a person might come to prefer or accept a different set of skin temperature or sweat rates for comfort. [19]

Gail S. Brager and **Richard J. de Dear** published in 1997 a literature study on thermal adaptation in the built environment [20] and developed an adaptive model of thermal comfort [21] (**Figure 8**). This research was subsequently included in ASHRAE Standard 55. The field studies made it clear that Fanger’s PMV-index might be too strict for non-air-conditioned buildings where users themselves could have control over the indoor environment. In other words, where people have the possibility to influence their environment (for example by opening windows).

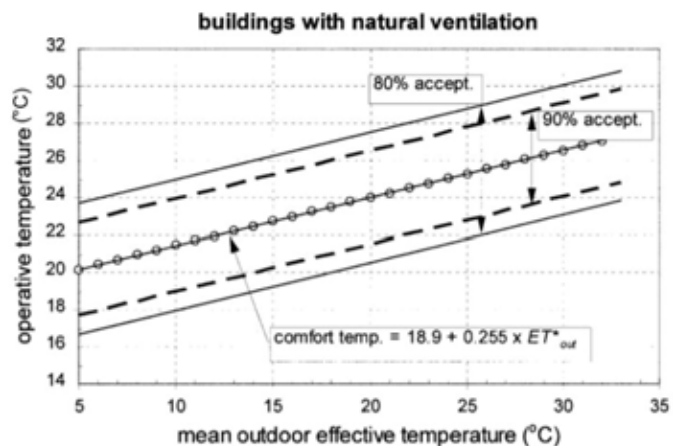

Figure 8. The shift in attention to the three health aims of building services that constitute complete health (Source: reference 22)

Before the 21st century

From the indoor environment developments during the past three centuries it can be concluded that health had priority in the beginning. In the 18th century people wanted to have a healthy environment in buildings in order to prevent the spread of diseases. Later, the indoor environment problems were dominated by comfort issues [22] (Figure 9). People wanted to be able to realize comfortable indoor conditions throughout the year. After the oil crisis in the 1970s, the main goal was to save as much energy as possible on indoor environment conditioning. Towards the end of the 20th century, sustainability became very important. In the Netherlands, sustainability was primarily seen in the form of fossil energy. For example, Trias Energetica with special attention for energy saving (isolation of buildings) and generation of sustainable energy (use of solar boilers and later PV panels). Only a few years ago (beginning of the 21st century) people regained interest in health in the build environment. New topics regarding indoor

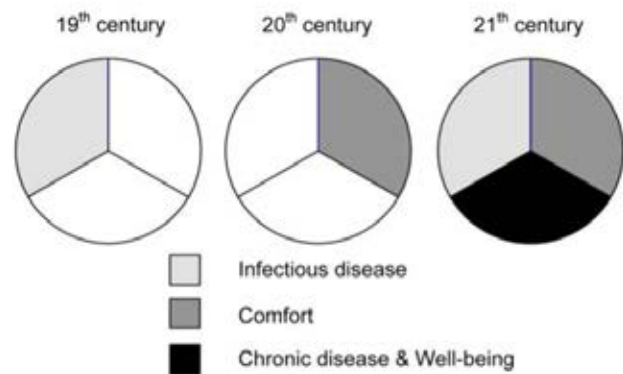

Figure 9. Indoor environment problems dominated by comfort issues.

environment are being discussed, such as influence of the indoor environment on productivity or supporting health and well-being of building occupants. These are nowadays topics which don't belong to history yet. ■

References

- [1] B. Nagengast, "An Early History Of Comfort Heating," *ACHRNEWS.com*, 2001.
- [2] J. Sundell, "On the history of indoor air quality and health," *Indoor Air*, vol. 14, no. 7, pp. 51–58, 2004.
- [3] J. E. Janssen, "The History of ventilation and Temperature Control," *ASHRAE J.*, vol. October, pp. 48–70, 1999.
- [4] C. Iddon, "Florence Nightingale: nurse and building engineer," 2015. [Online]. Available: <http://www.cibsejournal.com/general/florence-nightingale-nurse-and-building-engineer/>.
- [5] F. Nightingale, *Notes on Nursing, What It Is, and What It Is Not*. 1859.
- [6] B. Roberts, "ALFRED WOLFF AIR CONDITIONING PIONEER," 2014. [Online]. Available: http://www.hevac-heritage.org/built_environment/pioneers_revisited/wolff.pdf.
- [7] B. Nagengast, "Early Twentieth Century Air-Conditioning Engineering," *ASHRAE J.*, no. March, pp. 55–62, 1999.
- [8] L. Hill, M. W. Flack, J. McIntosh, R. A. Rowlands, and H. B. Walker, "The Influence of the atmosphere on our health and comfort in confined and crowded places," *Smithson. Misc. Collect.*, vol. 60(23), 1913.
- [9] J. Clayton, "Behind the picture: Leonard Hill and the divers," 2014. [Online]. Available: <http://www.insight.mrc.ac.uk/2014/08/13/behind-the-picture-leonard-hill-and-the-divers/>.
- [10] F. Houghten and C. Yaglou, "Determination of the comfort zone," *ASHVE Trans* 29, vol. 29, pp. 165–176, 1923.
- [11] A. Auliciems and S. V. Szokolay, "Thermal comfort," *PLEA Notes*, p. 66, 2007.
- [12] C. P. Yaglou, "Ventilation Requirements," *ASHVE Trans.*, vol. 42, 1936.
- [13] A. Gagge, "The linearity criterion as applied to partitional calorimetry," *Am. Physiol. Soc.*, vol. 116, no. 3, pp. 656–668, 1936.
- [14] K. Fabbri, "A Brief History of Thermal Comfort: From Effective Temperature to Adaptive Thermal Comfort," in *Indoor Thermal Comfort Perception: A Questionnaire Approach Focusing on Children*, 2015, pp. 1–302.
- [15] P. Fanger, "Thermal comfort. Analysis and applications in environmental engineering," *Therm. Comf. Anal. Appl.* . . . , 1970.
- [16] J. Van Hoof, "Forty years of Fanger's model of thermal comfort: Comfort for all?," *Indoor Air*, vol. 18, no. 3, pp. 182–201, 2008.
- [17] P. M. Bluysen, *The Indoor Environment Handbook*, vol. 165, no. 3. 2012.
- [18] P. A. Vroom, *Psychologische aspecten van ziekmakende gebouwen*. ISOR, 1990.
- [19] M. A. Humphreys and J. F. Nicol, "Understanding the adaptive approach to thermal comfort," in *ASHRAE Transactions*, 1998, vol. 104, no. Pt 1B, pp. 991–1004.
- [20] G. S. Brager and R. J. De Dear, "Thermal adaptation in the built environment : a literature review," *Energy Build.*, vol. 27, pp. 83–96, 1998.
- [21] R. De Dear, G. Brager, and C. Donna, "Developing an adaptive model of thermal comfort and preference," *ASHRAE Trans.*, vol. 104, no. Part 1, pp. 1–18, 1998.
- [22] F. Franchimon, "Healthy building services for the 21st century," doctoral dissertation, Technische Universiteit Eindhoven, 2009.

CEN Standard EN 16798-3:2017 on ventilation for non-residential buildings: PERFORMANCE REQUIREMENTS



LIVIO MAZZARELLA
Prof of Building Physics and HVAC Systems Full Professor at Politecnico di Milano – Department of Energy – Milan – Italy
AiCARR Vice president – REHVA Fellow
livio.mazzarella@polimi.it



JAAP HOGELING
EPB Center,
Jaap.hogeling@epb.center

Introduction

August 2017, CEN published the new standard EN 16798-3:2017 “Energy performance of buildings - Ventilation for buildings – Part 3: For non-residential buildings – Performance requirements for ventilation and room-conditioning systems (Modules M5-1, M5-4)”, which supersedes the EN 13779:2007. This standard has been produced to meet the requirements of Directive 2010/31/EU 19 May 2010 on the energy performance of buildings (recast), referred to as “recast EPBD”, while the substituted EN 13779:2007 was produced to meet the requirements of previous Directive 2002/91/EC 16 December 2002 on energy performance of buildings referred to as “EPBD”. Today, a new recast of the energy performance buildings directive is ongoing and should be finalized on April 2018, but that should not have a significant influence on this specific standard at least for other ten years. This

standard shall be given the status of a national standard at the latest by February 2018.¹

This European Standard is part of a series of standards aiming at international harmonization of the methodology for the assessment of the energy performance of buildings under a mandate given to CEN by the European Commission, called ‘recast EPBD’ standards or just EPB standards. These standards have a new common format: two documents for each standardized item, a true standard EN xxxx and a supporting technical report CEN/TR xxxx. The former reports a set of normative rules, while, the latter explains how to apply the related EN standard and gives informative additional rules and data. Because the EPB standards have been produced with the aim of supporting the recast EPBD and its application at national level, a certain degree of freedom in their application was a mandatory request. Thus, these standards provide a certain flexibility regarding the methods, the required

¹ Meanwhile CEN/TC156/WG20 works on an update of this standard. This to optimise the convergence with other EPB standard and the future TS’s regarding natural and hybrid ventilation systems (see article in RJ 2018-01). This update may also include a better aligning with the filter standards and ErP standards on ventilators. The purpose of this revision is to consider further developments in the framework for this standard

- Revision of filtration aspects considering ISO 16890 in particular: (Chapter 9.7 and Annex a 4.2. and B.4.2.)
- Possible conflict between FprEN 16798-3 and EN 15287-1 (which might have consequences TR 16798-4)
- Check of mandatory requirements on conflicts with national EPBD requirements (including the recast version of 2018), relevant for Annex A and B and the clearly split between EPBD and general design aspects)
- Editorial improvements.
- Links in to new work on natural ventilation shall be clarified (including TR 16798-4 if needed).
- Aspects considering climate change in particular the design temperatures for ventilation and cooling (Chapter 8).
- Clarification regarding ongoing work on EN 13053 and EN 308.
- Check possibilities to add informative (non EPBD related) Annexes based on TR 16798-4 information.

input data and references to other EPB standards, by the introduction of a normative template in Annex A and Annex B with informative default choices. The normative annex A is just an empty format that has to be filled at the national level to customize the standard in a way of complying to national legal requirements.

Nevertheless, the main goal of this standard is the energy performance of ventilation systems, EN 16798-3 also provides requirements especially for designers, installers, manufacturers, building owners and users, on ventilation, air-conditioning and room-conditioning systems in order to achieve a comfortable and healthy indoor environment in all seasons with acceptable installation and running costs. It focuses on the system-aspects for typical applications and covers the following:

- Important aspects to achieve and maintain a good energy performance in the systems without any negative impact on the quality of the indoor environment.
- Definitions of design and performances data.

Changes respect to EN 13779

The new EN 16798-3:2017, and its supporting technical report: CEN/TR 16798-4:2017, is just the revision of EN 13779:2007, which covers exactly the same items; this revision concerns mainly the following aspects:

- The document was split in a normative part, containing all the normative aspects and a supplementary technical report containing additional information and informative annexes, i.e. CEN/TR 16798-4:2017;
- The standard allows a normative national annex;
- New structure to clarify designing and calculation aspects;
- Clear coordination with prEN 16798-1:2015, outdoor air volume flows have been shifted to prEN 16798-1:2015;
- All indoor air quality aspects have been deleted and reference is made to prEN 16798-1:2015, supply air quality have been introduced;
- Update of definitions of systems;
- Update of SFP definitions and links to EU 327/2014 regulation;
- Update of heat recovery aspects;
- Update of filtration aspects;
- Update of leakages aspects;
- Aspects of energy performance have been updated;
- The standard was supposed to be updated to cover hourly/monthly/seasonal time-step, but this is not really done.

Coordination with prEN 16798-1:2015

Apparently, the major issue related to this review is the “clear coordination with prEN 16798-1:2015”, the revision of the EN 15251:2017 dealing with indoor environmental input parameters didn’t pass the formal vote and is under editorial revision (i.e. not yet available)². Thus, the default standard outdoor air volume flows, not any more included in the EN 16798-3:2017, are not defined until the revised prEN 16798:2015 will become a standard (probably after summer 2018). Of course, this could not be a problem if we recall the sentence reported in the superseded EN 13779:2007 at paragraph 7.4.1, “*The design shall be based whenever possible on the real data for the project*”. But, “*However, if no values are declared, the default values given in Table 12 shall be applied.*” That means that we have a lack of standardized information only when the standard is used for design purposes, while, when assessing the energy performance flow rate, design values should be already defined and available, i.e. declared. Anyhow, some information can be taken from the still in force EN 15251:2007, informative Annex B, until the revised prEN 16798-1:2015 will be approved and published.

What has been lost in this revision is the basic classification of the indoor air quality (from IDA 1 to IDA 4, table 5 of EN 13779:2007). This is not included in the prEN 16798-1:2015, while, in all table dealing with indoor air quality, both in normative and informative annexes, the flow rates are referred to undefined I, II, III and IV classes. Hopefully, its revision can include this lost definition.

Actually, the major issue is the delay on the approval of the prEN 16798-1:2015 itself, because this standard defines the target parameters for designing a high quality indoor environmental building, other than for assessing its yearly energy performance. This affects not only some input to EN 16798-3:2017 but to the whole EPB package of standards. Again, this delay can be fruitful used to improve that standard, which does not clearly define how the quality class of each aspect of the indoor environment (thermal, air quality, humidity, acoustics and lighting) is weighted or not to define the IEQ (Indoor Environmental Quality) class of the building. In addition, some indoor environmental aspects are qualified with three classes, some with four classes, and again no rules are given how to combine them to obtain the IEQ class.

² It is expected that the second formal vote on prEN16798-1 is expected around May 2018.

Update of definitions of systems

In the 16798-3:2017 the ventilation system paragraph has been improved including definitions for basic system types of ventilation systems (**Table 1**) as unidirectional ventilation system (UVU), bidirectional ventilation systems (BVU), natural ventilation system and hybrid ventilation systems.

The EN 13779:2007 “pressure conditions in the room” paragraph is now more clearly renamed as “design air flow balance” and explicitly refers to balanced mechanical ventilation system (BUV type), where the extract

airflow rate is given as function of the supply airflow rate and the air balance class needed.

Another comprehensive table (**Table 2**) is added to classify ventilation or air-conditioning systems based on ventilation and thermal functions.

A clear definition of cooling is also given as “any component in the unit or the room lowering the supply air or room air enthalpy (for example cooling coil with chilled water, cooling water or ground source water or brine)”.

Table 1. Basic system types of ventilation systems.

Description	Name of the system type
Ventilation system with a fan assisted air volume flow in only one direction (either supply or exhaust) which is balanced by air transfer devices in the building envelope.	Unidirectional ventilation system (UVU)
Ventilation system with a fan assisted air volume flow in both direction (supply and exhaust)	Bidirectional ventilation system (BVU)
Ventilation relying on utilization of natural driving forces	Natural ventilation system
Ventilation relying to both natural and mechanical ventilation in the same part of a building, subject to control selecting the ventilation principle appropriate for the given situation (either natural or mechanical driving forces or a combination thereof).	Hybrid ventilation system

Table 2. Types of Ventilation-, Air-conditioning-, and Room Conditioning-Systems based on functions.

System	Supply Air Fan	Extract Air Fan	Secondary Fan	Heat Recovery	Waste heat pump	Filtration	Heating	Cooling	Humidification	Dehumidification
Unidirectional supply air ventilation system (Positive pressure ventilation)	x	-	-	-	-	o	o	-	-	-
Unidirectional exhaust air ventilation system	-	x	-	-	o	-	-	-	-	-
Bidirectional ventilation system	x	x	-	x	o	x	o	-	-	-
Bidirectional ventilation system with humidification	x	x	-	x	o	x	o	-	x	-
Bidirectional air-conditioning system	x	x	-	x	o	x	o	(x)	o	(x)
Full air-conditioning system	x	x	-	x	o	x	x	x	x	x
Room air conditioning system (Fan-Coil, DX-Split-Systems, VRF, local water loop heat pumps, etc.)	-	-	x	-	-	o	o	x	-	(x)
Room air heating systems	-	-	x	-	-	o	x	-	-	-
Room conditioning system	-	-	-	-	-	-	o	x	-	-

Update of SFP definitions

The specific fan power classification has been extended respect to EN 13779:2007 adding a SPF 0 category for less than 300 W/(m³/s) and its definition is now clearly stated through a formula:

$$P_{SFP} = \frac{P}{q_v} = \frac{\Delta p_{tot}}{\eta_{tot}} = \frac{\Delta p_{stat}}{\eta_{stat}} \left[\frac{W}{m^3/s} \right]$$

(for the meaning of the symbols refer to the standard).

Paragraphs have been added to give as normative formulas and calculation methodologies for calculating:

- the power demand of the fan;
- Specific Fan Power of an entire building;
- Specific Fan Power of Individual Air Handling Units (I-AHU);
- AHU related PSFP values.

Similar formulas and calculation methodologies were also reported in the superseded EN 13779-2007, but only as informative options in the informative Annex D.

Update of heat recovery aspects

The heat recovery paragraph has been completely rewritten, updated and extended. The “dry” recovery efficiency has been introduced, as stated in EN 308 and EN 13053, but, unfortunately, a wrong symbol has been used: Φ_r instead of η_r . Some information is then reported on transfer of humidity, icing and defrosting, transfer of pollutants.

Update of filtration aspects

The filtration paragraph³ is entirely new and gives guidance in filters selection. In fact, depending on outdoor particle pollution level and desired supply air quality, different levels of filtration are required. The filtering of outdoor air shall be chosen to meet the requirements of the indoor air in the building, taking into consideration the category of outdoor air. Tables are given to define the minimum required filtration efficiency according to the selected outdoor air (ODA) quality and the supply air (SUP) class (**Table 3**) and to indicate when optional gas filtration is recommended or required (**Table 4**).

³ All specifications are based on EN 779 which currently is replaced by ISO 16890. The ongoing review on EN 16798-3 will revise this paragraph keeping the basic principle.

Table 3. Minimum filtration efficiency based on particle outdoor air quality.

Outdoor air quality	Supply air class				
	SUP 1	SUP 2	SUP 3	SUP 4	SUP 5
ODA (P) 1	88% ^a	80% ^a	80% ^a	80% ^a	Not specified
ODA (P) 2	96% ^a	88% ^a	80% ^a	80% ^a	60%
ODA (P) 3	99% ^a	96% ^a	92% ^a	80% ^a	80%

^a Combined average filtration efficiency over a single or multiple stage filtration in accordance to average filtration efficiency specified in EN 779.

Table 4. Application of gas filter as complement to particle filtration based on gaseous outdoor air quality,

Outdoor air quality	Supply air class				
	SUP 1	SUP 2	SUP 3	SUP 4	SUP 5
ODA (G) 1	recommended				
ODA (G) 2	required	recommended			
ODA (G) 3	required	required	recommended		

G = Gas filtration; should be considered if design SUP quality category is above design ODA quality category. Dimensioning should be done in accordance with EN ISO 10121-1 and EN ISO 10121-2.

The formula to calculate the combined filtration efficiency when different filters are used in series is given as:

$$E_t = 100 \cdot \left(1 - \left(\left(1 - \frac{E_{s,1}}{100} \right) \cdot \left(1 - \frac{E_{s,2}}{100} \right) \cdot \dots \cdot \left(1 - \frac{E_{s,n+1}}{100} \right) \right) \right)$$

where

E_t is the total filter efficiency

$E_{s,j}$ is the efficiency of each j filter step

Update of leakages aspects

The leakages in ventilation system paragraph is completely new. This paragraph was added because leakages of the air distribution or the AHU casing affect energy efficiency and function, as well as hygiene aspects (e.g. condensation). Thus, it is important to minimize leakages.

This paragraph specifically deals with leakages in heat recovery section (HRS) (internal leakages), leakages of the AHU casing (external leakages) and leakages of the air distribution (ducts) including components.

For leakages in heat recovery section, two new quantities are defined to quantify them:

- Exhaust Air Transfer ratio (EATR) [%]: ratio of the supply air mass flow rate leaving the HRS originated by air internal recirculation due to HRS internal leakages and the supply air mass flow rate leaving the HRS;
- Outdoor Air Correction Factor (OACF) [-]: ratio of the entering supply mass airflow rate and the leaving supply mass airflow rate.

With these two values, the leakage situation is fully defined. EATR and OACF shall be calculated by the heat recovery manufacturer for the nominal design condition of the air handling unit.

Based on the OAC Factor a classification is given as reported in **Table 5**.

Table 5. Classification of outdoor air correction factor – Internal leakages.

Class	OACF	
	Outdoor to exhaust air	Extract to supply air
1	1,03	0,97
2	1,05	0,95
3	1,07	0,93
4	1,01	0,90
5	Not classified	

For leakages of the AHU casing, reference is made to EN 1886:2007 - Ventilation for buildings. Air handling units. Mechanical performance, which specifies test methods, test requirements and classifications for air handling units.

For leakages of the air distribution, ducts mainly, a classification is given based on EN 12599 - Ventilation for buildings - Test procedures and measurement methods to hand over air conditioning and ventilation systems, as reported in **Table 6**.

Table 6. Classification of system air tightness class.

Air tightness class		Air leakage limit (f_{max}) $m^3 s^{-1} \cdot m^{-2}$
Old	New	
	ATC 7	not classified
	ATC 6	$0,0675 \times p_t^{0,65} \times 10^{-3}$
A	ATC 5	$0,027 \times p_t^{0,65} \times 10^{-3}$
B	ATC 4	$0,009 \times p_t^{0,65} \times 10^{-3}$
C	ATC 3	$0,003 \times p_t^{0,65} \times 10^{-3}$
D	ATC 2	$0,001 \times p_t^{0,65} \times 10^{-3}$
	ATC 1	$0,00033 \times p_t^{0,65} \times 10^{-3}$

Some information on system air tightness was given also in the superseded EN 13779-2007, but only as informative option in the informative Annex A.

Update of energy performance aspects

The calculation and energy rating paragraph deals with the air volume flows calculations, which was partially included in EN 13779:2007 in the supply airflow rate section, and a new part devoted to the energy rating of the ventilation systems.

The major update to the air volume flows calculations is the explicit introduction of the ventilation effectiveness, ϵ_V , when calculating the ventilation air volume flow (i.e. outdoor air flow to dilute indoor contaminants) starting from normalized standard requirements as in the referred prEN 16798-1:2015.

Another update is the calculation of the required ventilation rate for humidifying or dehumidifying, if such services are provided by the ventilation systems.

What is not reported is a procedure or a criterion for selecting the effective supply airflow rate, when the ventilation air volume flow, the air volume flow required for balancing heating and cooling loads and, eventually, required ventilation rate for humidifying or dehumidifying have to be contemporary or not satisfied.

The new paragraph is on the energy rating of ventilation system, which starts with a wrong internal reference to sub-paragraph 8.8.2 to 8.8.4 (which is a typo, they do not exist and should be 9.8.2 and 9.8.4; the same in clause 10.3.2 where the references should be 9.5.4 and 9.5.6); while probably, that should be just points 3, 4, 5 and 11 of 8.8 and 8.9 paragraph. The new

quantities herewith introduced, but already defined in the EN 13053 standard in a bit different way (in terms of powers instead of annual energies), are:

- Annual heat recovery efficiency,

$$\eta_e = 1 - \frac{Q_{H;V;in;req}}{Q_{H;V;tot}}$$

- Annual coefficient of performance

$$\epsilon_{HRS} = \frac{Q_{hr}}{E_{V;hr;gen;in;el}}$$

where

$Q_{H;V;in;req}$ is annual heating energy of ventilation supply (or/and intake) air including defrosting, in kWh

$Q_{H;V;tot}$ is annual heating energy of supply (or/and intake) air without heat recovery, in kWh

Q_{hr} is annual heat transferred by heat recovery, in kWh

$E_{V;hr;gen;in;el}$ is annual electric energy of the heat recovery section required by fans and auxiliaries, in kWh.

It should be noted that a wrong symbol is used in the standard for the heat recovery efficiency compared to the EN 13053 symbols (ϵ_{SUP} instead of η_e) and wrong unit symbol and in the wrong position appears in the Q_{hr} and $E_{V;hr;gen;in;el}$ explanation (kW instead of kWh). In addition, the annual attribute is lost in such explanations.

Finally, a section is added that deals with primary energy use of ventilation in kWh/(m³/h)/a. A formula to calculate this primary energy use is given but it is useless because of some undefined and unreferenced terms (see below).

$$E_{P,AHU} = \frac{(E_V + W_{V,aux} + W_{HU,aux}) \cdot f_{P,E} + Q_H \cdot f_{P,H} \cdot f_H + (Q_C + Q_{DH}) \cdot f_{P,C} \cdot f_C + E_{HU} \cdot f_{P,HU} \cdot f_{HU}}{Q_{V;SUP;AHU;nom}}$$

where

$f_{P,E}$, $f_{P,H}$, $f_{P,C}$, and $f_{P,HU}$, are primary energy factors, respectively, for electricity, heating, cooling and humidification; $(E_V + W_{V,aux} + W_{HU,aux})$, Q_H , $(Q_C + Q_{DH})$ and E_{HU} the related energies required as input to the air handling unit, and f_H , f_C , and f_{HU} are reported to be “delivered energy factor for” respectively heat, cold and humidification “(taking into consideration distribution and generation). Such factors are not defined in any place of the standard and there is no reference to any other standards where their definition can be found. It is opinion of the authors that such delivered energy factor has the meaning of ratio of required energy carrier delivered to the building for such service (Heating, Cooling, and Humidification) and the required energy input to the AHU for the same service. With this definition it automatically accounts for distribution and generation losses, as mentioned in the description.

Is it able to cover hourly/monthly/seasonal time-step as declared?

In the European Foreword to these standards is mentioned that “*the standard was updated to cover hourly/monthly/seasonal time-step*”. Instead, there is no mention of this update or possibility that the energy performance parameters are defined on annual basis. Nevertheless, this standard is useful as it is because its main goal is to define design flow rates complying with ventilation, heating, cooling and humidification requirements and to size the ventilation unit or AHU ventilation section according to the design requirements. The energy performance calculation is instead carried out, taking into consideration different calcula-

tion time step, in other standards like EN 16798-5-1:2017 or EN 16798-5-2:2017.

Supporting technical report, CEN/TR 16798-4:2017

The technical report, CEN/TR 16798-4:2017, is the supporting report of EN 16798-3:2017. As stated at the beginning, the technical report includes additional non-normative information and application examples.

In this case, almost all the materials included in the superseded EN 13779:2007 as informative appendixes have been moved to this reports, updated and expanded. ■

References

CEN. 1997. “Heat exchangers - Test procedures for establishing performance of air to air and flue gases heat recovery devices”. European Standard EN 308:1997. Brussels.

CEN. 2007. “Ventilation for buildings. Air handling units. Mechanical performance, which specifies test methods, test requirements and classifications for air handling units”. European Standard EN 1886:2007. Brussels.

CEN. 2007. “Ventilation for non-residential buildings – Performance requirements for ventilation and room-conditioning systems”. European Standard EN 13779:2007. Brussels.

CEN. 2007. “Indoor environmental input parameters for design and assessment of energy performance of buildings addressing indoor air quality, thermal environment, lighting and acoustics”. European Standard EN 15251:2007. Brussels.

CEN. 2011. “Ventilation for buildings – Air handling units - Rating and performance for units, components and sections”. European Standard EN 13053:2006+A1:2011. Brussels.

CEN. 2013. “Ventilation for buildings - Test procedures and measurement methods to hand over air conditioning and ventilation systems”. European Standard EN 12599:2013. Brussels.

CEN. 2015. “Energy performance of buildings - Part 1: Indoor environmental input parameters for design and assessment of energy performance of buildings addressing indoor air quality, thermal environment, lighting and acoustics - Module M1-6”. European Standard prEN 16798-1:2015. Brussels.

CEN. 2017. “Energy performance of buildings - Ventilation for buildings - Part 3: For non-residential buildings – Performance requirements for ventilation and room-conditioning systems (Modules M5-1, M5-4). European Standard EN 16798-3:2017. Brussels.

CEN. 2017. “Energy performance of buildings - Ventilation for buildings - Part 4: Interpretation of the requirements in EN 16798-3 - For non-residential buildings – Performance requirements for ventilation and room-conditioning systems (Modules M5-1, M5-4)”. Technical Report CEN/TR 16798-4:2017. Brussels.

CEN. 2017. “Energy performance of buildings - Ventilation for buildings - Part 5-1: Calculation methods for energy requirements of ventilation and air conditioning systems (Modules M5-6, M5-8, M6-5, M6-8, M7-5, M7-8) - Method 1: Distribution and generation”. European Standard EN 16798-5-1:2017. Brussels.

CEN. 2017. “Energy performance of buildings - Ventilation for buildings - Part 5-2: Calculation methods for energy requirements of ventilation systems (Modules M5-6, M5-8, M6-5, M7-5, M7-8) - Method 2: Distribution and generation”. European Standard EN 16798-5-2:2017. Brussels.

Energy efficiency of Remote Refrigerated Display Cabinets beyond the implementation of the Ecodesign and Energy Labelling Directives

KIYAN VADOUDI

Eurovent Certita
Certification
50 Rue de la Victoire
Paris, France
k.vadoudi@eurovent-certification.com

DAN BIBALOU

Eurovent Certita
Certification
50 Rue de la Victoire
Paris, France

SANDRINE MARINHAS

Eurovent Certita
Certification
50 Rue de la Victoire
Paris, France

This article discusses the impact of energy labelling on the energy performance distribution of Remote Refrigerated Display Cabinets (RRDC's). We compared the distribution derived from the energy classes developed in a previous study by Marinhas (2012) to that derived from the draft Energy Labelling regulation from the European Commission (EC). Our comparisons are based on a sample of 3,000 certified data points covering all the "standard" geometries/types of RRDCs available on the European market. Our headline conclusion suggests that the impact of these schemes will be extremely positive. That is, the average performance of a given RRDC is very likely to be higher than it was prior to the introductions of those ratings because of the rolling minimum energy performance and the exigence of the market for a more stringent energy classes. Indeed, using the proposed EU energy labelling regulation method more than 74% of the sample will receive the label "E" or worse, the lower end of the scale ranging from "A" to "G".

Keywords: Remote Refrigerated Display Cabinets (RRDC's), Ecodesign, Energy Labelling, Energy Efficiency, Refrigeration

Supermarkets are one of the most energy-intensive building groups in the commercial sector and up to half of this energy is consumed by the Refrigerated Display Cabinets (RDC's) [1]. Energy performance of these products are directly related to the refrigeration load which is depends on case type (see later **Table 2**). Currently, standardised testing methods [2, 3, 4, 5] are used to determine the energy label/class of RDC's, a policy which is expected to foster improvement in the energy performance of the RDC market. Energy labels are designed to provide supermarket buyers with graphical and easy scale representing the energy performance of a given RDC and as a result the purchase of those display cases is likely to be easier and lead to that a reduction of their energy cost over the life span of the equipment [6]. European energy labelling uses a system with letters printed on the physical plate/label. In this rating system, the letter "A+" indicates that a

product has a high energy efficient, whereas the letter "G" indicates the contrary.

Eurovent Certita Certification (ECC) supports European consumers in their selection of the most energy efficient Heating, Ventilation, Air Conditioning (HVAC) and refrigeration equipment [7]. ECC programmes for RRDC covers 100 pre-defined categories of cabinets. In total, ECC conducts more than 500 audits performed per year for 41 certification programmes. Those programmes are underpinned by both factory audits and independent laboratory testing. At this stage, ECC's energy labelling scheme is only applicable for remote refrigerated display cabinets (i.e. units with remote condensing units placed in a machinery room) [8].

The integrity of the certification programme is ensured with an annual audit of production facilities as well

as testing in independent laboratories. The purpose of those audits is to ensure that the products sold by the factories perfectly match the declared component and performance characteristics of the models provided to Eurovent. During the visit, the auditor checks the production line and reviews recent orders to verify their compliance. By regularly testing the finished units according to ISO standard 23953[5], it is ensured that the efficiency levels are in phase with those indicated in the catalogues. In other words, this process is an effective means of guaranteeing that a declared “B” labelled cabinet will not actually deliver performance data equivalent to those of a “D”.

RRDC market is steadily growing in EU-28

RRDC’s are available in different sizes and geometries and according to the breakdown shown in **Figure 1**, multidecks command a market share of 61% of the sales of RRDCs whilst counters account for approximately 16% market share [9].

RRDCs have an individual selling price ranging from € 3,000 to € 7,000, which is largely influenced by the

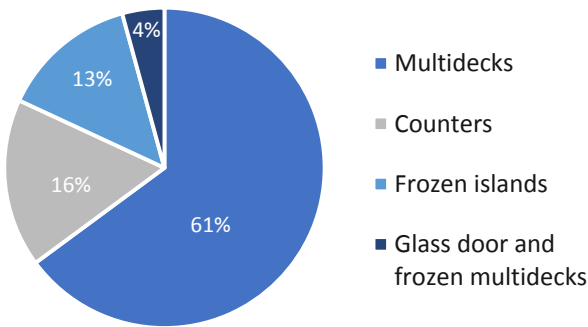

Figure 2. Sales value and volume for remote refrigerated display cabinets in EU-28.

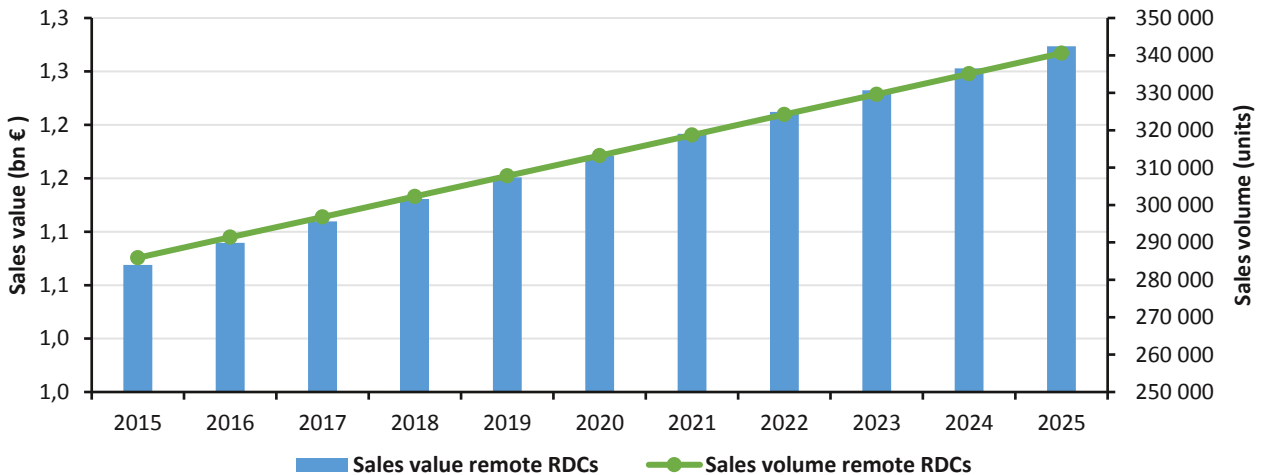

Figure 1. Respective market share for different geometries of remote RDCs.

size and type of units. The average price for a given RRDC is shown in **Table 1**.

According to the projections made by Eurovent Market Intelligence (EMI) for the EC back in 2014 more than 560k RRDC units were sold for a value of € 1.6 billion, that is a cumulative increase of 50% and 45% over the levels of 2004 for sales volume and value respectively. This trend is largely driven by the dynamism of the RRDC market which account for more than 70% of sales value since 2004. In addition, more than 70% of RRDC’s have been sold to replace the existing installed base. In 2018, this rate reached 86%, a proportion that provides the market with weak but steady growth.

The evolution of the sales value and volume for remote RDCs between 2015 and 2025 in EU-28 is illustrated in **Figure 2** highlights the increase of both sale volume and stock of remote RDCs, where the installed base is expected to grow steadily over the course of the period presented.

Table 1. Average prices of RDCs by geometry in EU-28. [9]

EUROVENT classification	EUROVENT classification	Average selling price
Multideck & semi-vertical	RVC1 / RVC2 / RVC3	€ 3,437
Counter service & self-service	RHC1 / RHC2 / RHC7 / RHC8 / RHF1 / RHF7	€ 3,017
Frozen food islands	RHC3 to RHC6 & RHF3 to RHF6	€ 3,966
Glass doors & frozen multideck/SV	RVF4 & RVC4 + RVF1 & RVF2	€ 5,935
Combis	RYC1 to RYC4 & RYF1 to RYF4	€ 6,779

Almost 70% of RRDC's are sold directly to end users, another third goes through a distributor step and 1% are directly via food and beverage companies [10]. Those distribution channels are shown in **Figure 3**.

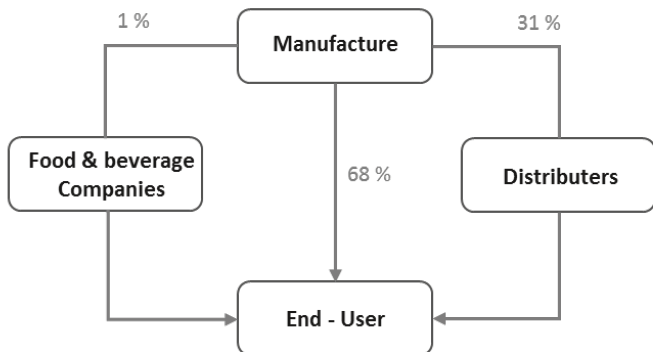

Figure 3. Distribution/ market map for RDC in EU-28. [10]

Policy instruments are set to positively affect the RRDC market energy consumption

Eurovent energy rating standard for RRDC (RS 14/C/001-2017)

When applying energy labelling to RDC's, there are two inputs of energy to take account of when evaluating the total energy consumption (TEC); these being; the direct electrical consumption (DEC) for lighting, evaporator fans, electrical defrost circuits and other direct electrical consumers and the consumption of liquid refrigerant, produced by the condensing unit.

$$TEC_{remote} = DEC + REC \tag{1}$$

TEC Total energy consumption

DEC Direct daily electrical energy consumption, in kilowatt hours per 24 h period

REC Refrigeration energy consumption

This input, the refrigeration energy consumption (REC), is represented in the energy labelling scheme by the energy consumption of an imaginary condensing unit:

$$REC_{RC} = (24 - t_{def}) \times \Phi_{24-def} \times \frac{T_c - T_{mrun}}{0.34 \times T_{mrun}} \tag{2}$$

REC_{RC} Refrigeration daily electrical energy consumption [kWh]

t_{def} Defrost time - time during defrost during which compressor is not running [h]

Φ_{24-def} Heat extraction rate during a whole day excepting defrost time [kW]

T_{mrun} Running time - time during which compressor is running [h]

T_c Constant condensing temperature [35 °C]

To calculate at the energy efficiency of a refrigerated display cabinet, the cabinet's total energy consumption TEC must be divided by the display area and storage temperature, which are the "functional" parameters of the cabinet. The total display area is the sum of the product surfaces seen from a vertical and from a horizontal perspective perpendicular to the cabinet.

$$EEI = \frac{\left(\frac{TEC}{TDA} \right)_{measured}}{\left(\frac{TEC}{TDA} \right)_{reference}} \tag{3}$$





EEI Energy Efficiency Index

TEC Total energy consumption

TDA Total display area

The quotient TEC/TDA gives the energy consumption of the cabinet per unit of area (in kWh/m²/day). Then, to normalise the resulting index is divided by the geometry specific European average reference shown in **Table 2**.

Table 2. Reference values for definition of Energy Efficiency Index (EEI). [8]

Type of cabinets	Temp. class	Reference EEI	Type of cabinets	Temp. class	Reference EEI	
	RVC1	3H		RHC1	3H	
		3M2			3M2	
		3M1/3M			3M1/3M	
		3M0			3M0	
	RVC2	3H		RHF1	3M0	
RVC3	3M2	RHC3	3H	RHC4	3H	
	3L3		3M2		3M2	
	3M0		3L3		3L3	
	3L1		3L1		3L1	
	RVC4	3H		RHF3	3H	
		3M			RHF4	3H
		3M1/3M			3M	3M
		3M0			3M1/3M	3M0
	RYF3	3L2	RHC5	3M1/3M	3L2	
		3L3		RHC6	3L2	
	RYF4	3L2	RHF5	3L3	3L3	
		3L2	RHF6	3L2	3L2	
		3L3	RHF6	3L3	3L3	

A low EEI indicates that a given cabinet has a high energy efficiency, whereas a high value of the same index indicates the contrary. For ease of representation, and to fall in line with other EC labelling directives, a lettering system has been attached to this energy labelling methodology which translates the energy efficiency index into efficiency classes indicated by a single letter, ranging from “A” to “G” (with an “A+” for the most efficient cabinets). **Table 3** shows Eurovent’s energy efficiency classes for remote refrigerated display cabinets.

Table 3. Eurovent’s energy efficiency classes for remote refrigerated display cabinets. [8]

Energy efficiency class	Energy Efficiency Index (EEI)
A+	<40
A	40≤EEI<50
B	50≤EEI<53.5
C	53.5≤EEI<60
D	60≤EEI<90
E	>90

Ecodesign and Energy Labelling Directives

In the EU, the Ecodesign Directive [11],[14] sets a framework requiring manufacturers of energy-related products to improve the environmental performance of their products by meeting minimum energy efficiency requirements, as well as other environmental criteria such as water consumption, emission levels or minimum durability of certain components, before they can place their products on the market. As a complement, the Energy Labelling Regulation [13] enables end-consumers to identify the better-performing energy-related products, via an A-G/green-to-red scale. The legislative framework builds upon the combined effect of the two aforementioned pieces of legislation.

The policy initiative was launched in 2004-2005. The first preparatory study on Ecodesign for commercial

Table 4. European energy efficiency classes for commercial refrigeration equipment. [13]

Energy efficiency class	Energy Efficiency Index (EEI)
A	EEI < 10
B	10≤EEI<20
C	20≤EEI<35
D	35≤EEI<50
E	50≤EEI<65
F	65≤EEI<80
G	EEI≤80

refrigeration, which was finalised in 2007, identified the relevant environmental aspects of refrigerating appliances with a direct sales function, and analysed the legislative, technical, environmental, economic and behavioural aspects of commercial refrigeration. It showed that there was a significant energy savings potential for refrigerating appliances with a direct sales function. This was confirmed by an impact assessment that was conducted in the period 2008-2010.

In 2013-2014, the Joint Research Centre (JRC) updated the preparatory study and scenarios with different levels of energy efficiency were assessed a second time. The scenario with the stricter energy efficiency requirements in two tiers and an energy label was retained as the preferred scenario. By 2030, this scenario is estimated to result in:

- Electricity savings of 19 TWh/yr (48 TWh/y in primary energy terms) and GHG emission savings of 7.4 MtCO₂eq./a.
- Savings on annual end-user expenditure of EUR 2.9 billion and extra business revenue of EUR 0.4 billion per year.
- An alignment with technological progress and global minimum energy efficiency requirements in other economies.
- Contributing to EU industry’s competitiveness and leading role as high-quality manufacturers.
- Safeguarding of SMEs.

The energy label requirements, currently under World Trade Organisation (WTO), are expected to enter into force on 1st September 2019 onwards with the efficiency classes set out in **Table 4**. Those classes were defined to ensure a normal distribution between the different energy classes. The A class is expected to be empty in 2020. This is in line with the new Energy Labelling Framework Regulation [13]. The full implementation timeline will run from September 2019 to January 2025, its details are shown in **Figure 4**.

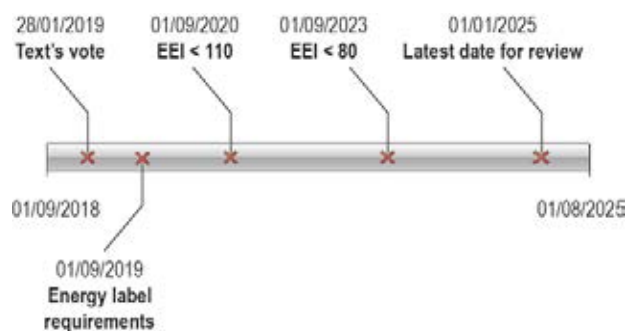

Figure 4. Ecodesign and Energy Labelling Directive timeline.

For all refrigerating appliances with a direct sales function, the EEI, expressed in % and rounded to the first decimal place, compares the Annual Energy consumption (AE) expressed in kWh/a with the reference Standard Annual Energy consumption (SAE) expressed in kWh/a and is calculated as:

$$EEI = \frac{365 \times E_{daily}}{SAE} \quad (4)$$

E_{daily} = The energy consumption of the cabinet over 24 hours (rounded to three decimal places).
 Note that E_{daily} = TEC from the 2005 version of the 23953.

The Standard Annual Energy consumption (SAE), expressed in kWh/a (rounded to two decimal places), is calculated as follows:

$$SAE = (M + N \times Y) \times 365 \times C \times P \quad (5)$$

All the parameters required to calculate the EEI according to the new version of the ISO standard 23953 are shown in **Table 5**.

Table 5. Temperature coefficient values for C, M and N. [13]

Geometry	T° class	Colder than / equal to	Warmer than / equal to	Package colder than / equal to	Value for C	Value M	Value N
Vertical, semi-vertical and combined supermarket refrigerator cabinets	M2	+7 °C	-1 °C	N/A	1	9.1	9.1
	H1/H2	+10 °C	-1 °C		0.82		
	M1	+5 °C	-1 °C		1.15		
Horizontal supermarket refrigerator cabinets	M2	+7 °C	-1 °C	N/A	1	3.7	3.5
	H1/H2	+10 °C	-1 °C		0.92		
	M1	+5 °C	-1 °C		1.08		
Vertical, semi-vertical and combined supermarket freezer cabinets	L1	-15 °C	-1 °C	-18 °C	1	7.5	19.3
	L2	-12 °C	-1 °C	-18 °C	0.9		
	L3	-12 °C	-1 °C	-15 °C	0.9		
Horizontal supermarket freezer cabinets	L1	-15 °C	-1 °C	-18 °C	1	4.0	10.3
	L2	-12 °C	-1 °C	-18 °C	0.92		
	L3	-12 °C	-1 °C	-15 °C	0.92		

Our comparative method is based on a sample of 3,000 data points

The comparison between the Eurovent and the European energy class distributions is based on a sample of 3,000 certified data points which are used to derive their respective Energy Efficiency Index (EEI) using the last two versions of the EN ISO 23953 test standard (2005 and 2015). The resulting performance indicators are used to determine the energy classes of the 3,000 cabinets using the methods defined by Eurovent and that used by the EC. Finally, those energy classes are amalgamated to create two performance distributions that will be the basis of the comparison. This process is shown in **Figure 5**.

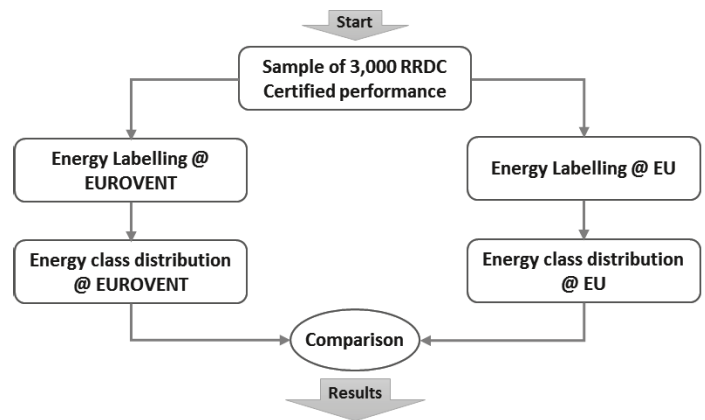

Figure 5. Methods for the comparison between the energy performance distribution based on the energy labels from ECC and European Energy Labelling Directive.

In our study the sample includes the performance data for 3,000 products certified between 2012 and 2018. ECC's method gives the label A+ to the best and the label E to the worst and all labels/classes are determined with the calculation of the EEI which is then used with ECC's energy efficiency classification for remote refrigerated display cabinets (see **Table 3**). Our results show that 47% of the products certified have a "D" energy class/label and merely 2% falls to the class "E". In addition, out of our sample of 3,000 RRDCs, 450 units (15%) qualify as high energy efficiency units (classes "A+" and classes "A"). That is, about 240 units (8%) reached the class "A+" and a further 210 units (7%) reached the energy class "A". The resulting energy class distribution is shown in **Figure 6**.

To evaluate the impact of the Energy Labelling Regulation [13] on ECC's energy classes distribution, we recalculated the EEI using both equation (4) and equation (5) with data from **Table 5**, that is despite the difference in scale between the two energy label ranges (ECC's ranges "A+ to E" whilst EC's ranges "A to G"). Our results show that 39% of the sample has an energy class of "E". At this stage, as expected by EC [13], no RRDCs have the label "A" but 1% or 30 units have of the label "B". A further 25% of the sample reached the labels "B" and "C" with respective share of 16% and 9%. The resulting energy class distribution is shown in **Figure 7**. The remainder of the sample reached the labels "F" and "G", a category of products that will be affected when the requirements for the Ecodesign Directive in terms of Minimum Energy Performance Standards (MEPS) enter into force in 2023 (see **Figure 4** where it can be seen that all RRDC's with an energy label "G", or an EEI of 80 or worse, will be banned from entry into the European market).

Conclusion

The objective of this article has been to compare the existing ECC's methodology for energy labelling [7]

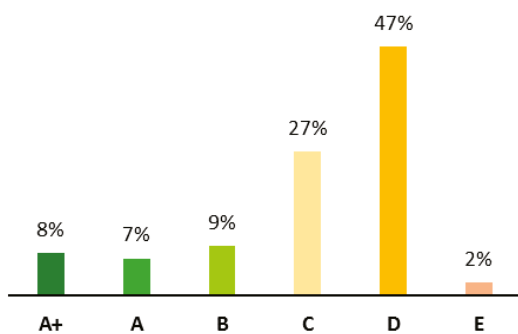

Figure 6. Energy classes distribution based on Eurovent's methods.

with that from the European Energy Labelling Directive [14] and to gauge the impact of this change. To this end, we looked at a sample of more than 3,000 data and should the latest draft of both regulations be implemented in its current state for the MEPS, EEI formula and the energy classes, one can argue that the EC is likely to be on course to meet its explicit objective of reducing the average energy consumption of RRDC's. This reduction is important since we have seen that the RRDCs is expected to grow steadily at a rate of 2% per year through 2030. However, should EC's text be amended, we anticipate seeing those changes in the reference values for C, M and/or N parameters.

Based on this comparison of two energy classes distributions, the label of the "average" RRDCs will worsen: in ECC's methods, this unit was likely to be rated/classed "D" or "C" whilst using EC's methods those ratings/classes are more likely to be "F" or "G". In addition, MEPS will result in the ban of all "G" labelled units in 2023, so in market worth more than a billion euro a year, one can expect manufacturers to intensify their research and development efforts to avoid having too many RRDCs units rated in the lower end of the distribution and to compete of the upper end of the distribution where the label "A" is likely to become the new energy efficiency frontier for RRDCs.

Future work will take our comparison further to include more parameters such as the standardised designation of a given RRDC's (See Table D.1 p.82 of EN ISO 23953-2:2015) and/or an attempt at measuring manufacturers sentiment after MEPS implementation. More details will also be provided regarding historical data. In the meantime, ECC also looks at the development of a dedicated certification program for Plug-in Refrigerated Display Cabinets. In addition, ECC's RRDC certification programme will align its requirements (see Rating Standard - RS-14C001) with those from both Ecodesign and Energy Labelling Directives. ■

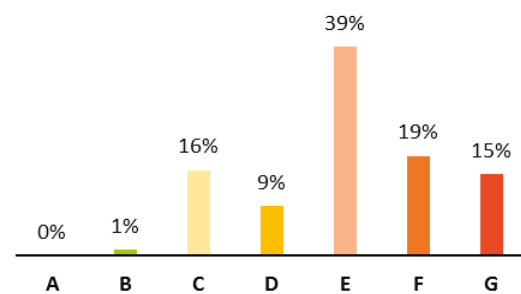
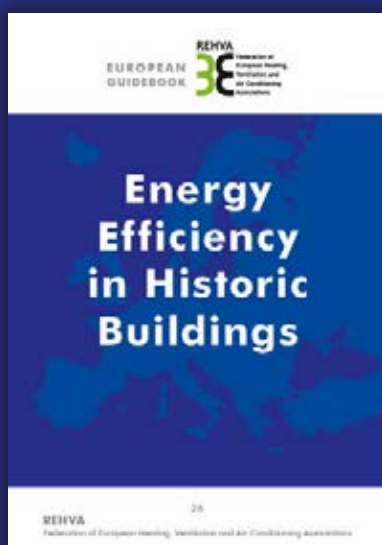

Figure 7. Energy classes distribution based on the methods set in the Energy Labelling Directive.

References

- [1] E. Geilinger and E. Bush, "Commercial and Professional Refrigeration Products: Promoting Energy Efficiency with Legislation, Empowered Stakeholders and Rebates."
- [2] ANSI/ASHRAE Standard 72-2018, Method of Testing Open and Closed Commercial Refrigerators and Freezers.
- [3] A. 1200 (I-P/2013), "Performance Rating of Commercial Refrigerated Display Merchandisers and Storage Cabinets."
- [4] ISO standard 23953-2:2015, Refrigerated Display Cabinets.
- [5] ISO standard 23953:2005, Refrigerated Display Cabinets.
- [6] D. H. Walker, "Investigation of energy-efficient supermarket display cases," ORNL, 2005.
- [7] <http://www.Eurovent-certification.com/index.php?lg=en>, "Eurovent Certita Certification."
- [8] S. Marinhas, "Performance Certification of Refrigerated Display Cabinets (RDC)," *REHVA J.*, vol. 62, 2012.
- [9] H. Moons *et al.*, "Ecodesign for Commercial Refrigeration-Preparatory study update-Final report. Joint Research Centre, Science and Policy Report. 2014," ISBN 978-92-79-39543-7.
- [10] Mudgal, S., Tinetti, B., Bain, J., Cervantes, C. and De Prado Trigo, A., (2007). Preparatory Study for Eco Requirements of EuPs Refrigerating and freezing Service cabinets, blast cabinets, walk-in cold rooms, chillers, water dispensers, ice-makers, dessert.
- [11] E. C. Directive, "Directive 2009/125/EC of the European Parliament and of the Council of 21 October 2009 establishing a framework for the setting of ecodesign requirements for energy-related products," *Off. J. Eur. Communities*, 2009.
- [12] L. Economics, "Study on the impact of the energy label-and potential changes to it-on consumer understanding and on purchase decisions," *London Econ. Ipsos Eur. Comm. Brussels*, 2014.
- [13] Regulation (EU) 2017/1369 OF The European Parliament and of the Council of 4 July 2017 setting a framework for energy labelling and repealing Directive 2010/30/EU.
- [14] G/TBT/N/EU/620 - Draft Commission Regulation laying down ecodesign requirements for refrigerating appliances with a direct sales function pursuant to Directive 2009/125/EC of the European Parliament and of the Council (10 pages + Annexes 13 pages, in English) ICS: 97.130.20.

REHVA European Guidebook No.26 Energy Efficiency in Historic Buildings



These guidelines provide information to evaluate and improve the energy performance of historic buildings, fully respecting their significance as well as their cultural heritage and aesthetic qualities. The guidelines are intended for both design engineers and government agencies. They provide design engineers with a tool for energy auditing the historic building and offer a framework for the design of possible energy upgrades, which are conceptually similar to those provided for non-protected buildings, but appropriately tailored to the needs and peculiarities of cultural heritage. These guidelines also provide the institutions responsible for protecting the building, the opportunity to objectively decide on the level of energy efficiency achieved as a result of the rehabilitation in accordance with the conservation criteria.

Certified commissioning of new & existing buildings

Commissioning is a process to enhance building quality and performance. It generates huge cost savings by identifying quality problems in real-time. Certified commissioning offers third party confidence in project quality and allows clients to rely on a standardized approach across projects and markets. COPILOT Building Commissioning Solutions uses protocols specially developed with REHVA experts to certify the commissioning of new and existing buildings. Commissioning Managers can enrich their offer by proposing COPILOT certification.

Keywords: commissioning, commissioning engineer, technical monitoring, HVAC performance, HVAC comfort, certified commissioning

Why commission HVAC systems?

HVAC systems are complicated technical systems, and building automation constantly increases complexity. This results in a performance gap: buildings do not work as intended and miss their performance targets. This is doubly costly: first, design and construction cause additional cost and then, later, operation cost are higher than expected.

The solution is commissioning, a quality-focused process for enhancing the delivery of projects.



The process focuses on verifying and documenting that all commissioned systems and assemblies are planned, designed, installed, tested, operated and maintained to meet Client's Objectives.

Commissioning of HVAC systems brings numerous advantages:

- Identify & solve problems in real-time, thereby avoiding high costs and time delays of later re-work
- Achieve required performance levels which means the building will be comfortable and occupants can work productively
- Add value as the tenants want to occupy functional buildings
- Reduce costs including energy, maintenance, equipment replacement and insurance

Perhaps the most important advantage is that commissioning reassures the client that his objectives, whatever they may be, have been respected.

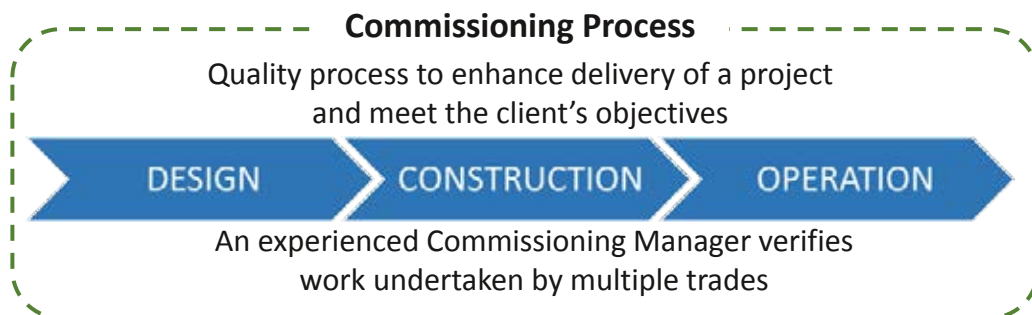

Figure 1. The commissioning process.



Figure 2. REHVA contribution to COPILOT protocols.

Why certify your commissioning?

Certification attests that the commissioning process has been correctly undertaken and documented. Certification schemes formalize a step-by-step process methodology. Projects must comply with formal requirements and demonstrate compliance via appropriate sign-offs and documentation. Formal identification of quality controls at each stage keeps the project on target as it travels through different trades and phases.

Third party certification defines protocols independent of the actors in a process. Certification of commissioning guarantees independence and strengthens the legitimacy of the commissioning process. It reinforces the position of the Commissioning Manager as it reinforces his authority.

What certified commissioning solutions does COPILOT propose?

COPILOT Building Commissioning Solutions certifies commissioning. **Experienced & independent Commissioning Managers** commission projects onsite using COPILOT protocols. Clients can use their normal Commissioning Manager on validation of his experience & competence and completion of a short training programme.

COPILOT proposes **contract templates** which include Designer & Contractor contract clauses to facilitate a smooth commissioning process. COPILOT's APP

permits Commissioning Managers to work with multiple trades, to commission the project and to document progress.



Figure 3. COPILOT's APP.

The Commissioning Manager workshops with clients to help them clarify and formalize **client objectives**. He then proposes appropriate **KPI indicators** which can be checked at each stage to ensure the project complies with

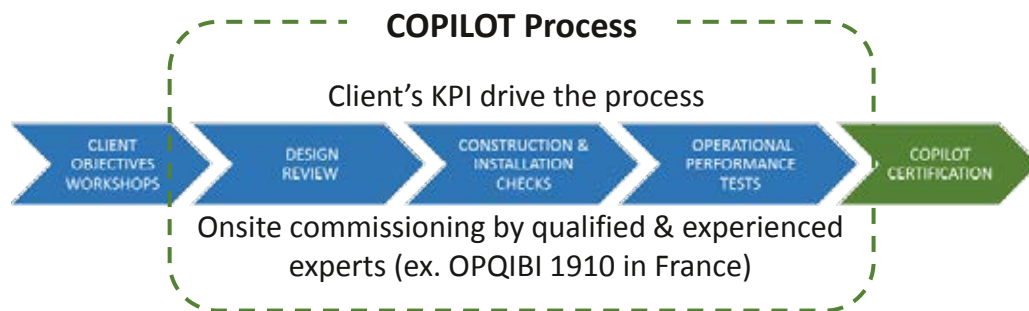

Figure 4. COPILOT certified commissioning process.



Figure 5. COPILOT projects.

the owner's objectives. The certification process covers the project life-cycle from pre-design to post-delivery. **Commissioning rigour** modulates according to priorities established by the client. A laboratory could, for example, view air quality and hence ventilation as a high priority but heating as a low priority. Commissioning work like sample testing is adjusted accordingly.

Certified projects are registered and **archived** in COPILOT's secure database. Project owners have access to all their projects filed in a **standardized** manner. This facilitates building portfolio comparison across projects & markets, life-cycle traceability, building maintenance & monitoring over time, and transfer of ownership. ■

Ventilation Ductwork Systems Certification for a Better Air Tightness

The implementation of the Energy Performance of Buildings Directive 2010/31/EU recast puts increasing pressure to achieve better building and ductwork airtightness.

Keywords: Ductwork system, Air tightness class, Energy efficiency, Indoor Air Quality



MARIE-CLÉMENCE BRIFFAUD

Project Development Engineer
Eurovent Certita Certification
mc.briffaud@eurovent-certification.com

In this context, Eurovent Certita Certification decided to establish a new certification programme for Ventilation Ductwork Systems, opening a new chapter in the history of the Eurovent Certified Performance (ECP) certification mark, which concerned only products, not systems, until then.

To meet this challenge, Eurovent Certita Certification worked for one year with a dedicated committee gathering six major European manufacturers of ventilation ducts and fittings. The development of the programme also involved consultation of European testing laboratories. The resulting requirements and rules defined for the DUCT programme rely on Ventilation ductwork system (typical setup) testing and production sites auditing.

The scope of the programme covers rigid and semi-rigid ventilation ductwork systems divided into the following sub-programmes:

- Rigid metallic ductwork systems with circular cross-section (DUCT-MC);
- Rigid metallic ductwork systems with rectangular cross-section (DUCT-MR);
- Semi-rigid non-metallic ductwork systems predominantly made of plastics (DUCT-P);

Among other verifications, the performance testing on typical set-ups enables to validate the airtightness class declared by the manufacturer. The production site auditing enables to verify the manufacturing process

steadiness. These two verifications combined ensure that the air tightness class claimed by the manufacturer can indeed be reached in practice.

The first certification of ventilation ductwork systems was granted by Eurovent Certita Certification in December 2017 as a new step towards good airtightness levels in buildings, contributing to the pursuit of nearly zero-energy buildings and improving indoor air quality.

Introduction

The Energy Performance of Buildings Directive (EPBD) recast published in 2010 (Directive 2010/31/EU) acknowledged that air tightness has an important role to play in the building energy consumption reduction [1]. With Nearly Zero-Energy Buildings as objective for new buildings, the directive is urging the whole building sector to consider it as a key parameter in the building conception.

In addition to the energy efficiency objectives, the buildings airtightness is an even more challenging topic for the construction sector professionals. Indeed, poorly designed, “too airtight”, buildings can compromise the Indoor Air Quality (IAQ), contributing to what is called the “sick-building syndrome”.

However, when the building is properly conceived and equipped with an appropriate ventilation system, the airtightness actually leads to better IAQ levels and thermal comfort.

Within the building construction elements, the ductwork system is crucial to reach proper energy consumption and IAQ levels. Indeed, studies evidenced that excessive ductwork leakage have a huge impact on energy use and Indoor Air Quality issues.

Besides the qualification of installers for an improved airtightness in-situ, the ductwork system intrinsic airtightness (resulting from the ductwork system constituting elements conception and manufacturing) appears to be of prime importance.

In this context of rising awareness of Indoor Air Quality challenges, Eurovent Certita Certification decided to contribute by establishing a new certification programme for Ventilation Ductwork Systems.

Airtightness regulatory requirements

More and more countries consider air-tightness in their national regulations, however the focus is set at the building level and the ductwork contribution is rarely given its due weight.

Besides, when minimum requirements for building air-tightness exist, the rating justification is not always mandatory.

Airtightness requirements for buildings in European countries

An increasing number of countries include in their regulations either required or recommended minimum airtightness levels (see **Figure 1**). Even though mandatory testing is not systematic yet, it gradually came into force in countries such as France, Ireland or the United Kingdom (see **Figure 2**) and the list continuously increases.

As an example, the French regulation (RT2012) introduced a minimum requirement for the building airtightness of all residential buildings and made justification of the value mandatory. For non-residential buildings, a default value is implemented for each building type and justification is mandatory to use a better value than the default one in the energy performance (EP) calculation. The building airtightness level is to be justified by



Figure 1. Do minimum building airtightness requirements exist in EP regulation?¹

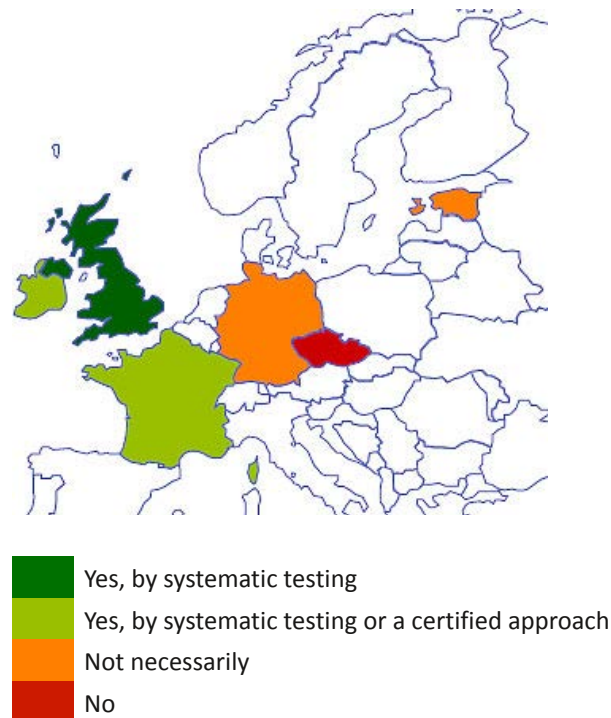

Figure 2. Does compliance to this requirement need to be justified?

¹ Source: Survey on building and ductwork airtightness requirements in Europe, Results obtained from 10 countries presented during TightVent Airtightness Association Committee-TAAC of January 2017

means of airtightness testing by a qualified tester. If a certified quality management approach is applied, only a sample of buildings is to be tested, otherwise testing is required for each building [2].

Airtightness requirements for ductwork systems in European countries

Scandinavian countries enhance airtight ductwork systems since the 1950s. For instance, in Sweden, the AMA (General Material and Workmanship Specifications) specification guidelines included tightness requirements in 1966. Since then, construction products manufacturers and installers have continuously cared for airtightness in their work and field measurements testify that Scandinavian countries reach very low air leakage in their ductwork installations [3].

In Europe, only the French (RT2012) and Belgian (EPB) regulations consider the ductwork airtightness as an input in the energy performance calculation. There is no minimum requirement but a good airtightness level, if justified, can reduce the calculated energy use. It is to be noted that in Belgium the leakage flow according to standard EN 14134:2004 [4] is applied whereas in France the value used in the calculation is the airtightness class determined according to standard EN 12237:2003 [5].

Measuring the ductwork leakage to verify the Airtightness class

Ductwork leakage can be measured in situ according to specific standards. This paper focuses on the intrinsic airtightness of ductwork systems, i.e. resulting from measurements conducted in a test laboratory.

The air-tightness classification goes from A (worst) to D (best). For metallic ducts with circular cross-section, the rating criteria (see **Table 1**) is established in standard EN 12237:2003 [5].

A leakage test is to be conducted according to EN 12237:2003 [5] or EN 1507:2006 [6] to verify the airtightness class rating.

For each test pressure p_t , the leakage factor f , ratio of the air leakage rate q_v (in m^3/s) observed during the leakage test and the ductwork surface area A (in m^2), shall be lower than the corresponding air leakage limit f_{max} which is calculated from the test pressure p_t as indicated in **Table 1**.

$$f = \frac{q_v}{A} \quad (1)$$

Besides no damage shall be observed on the ductwork (deflection, hole, etc.). This double verification must be successful for ten test pressures in the pressure range corresponding to the class (for example that is $[-750 \text{ Pa}; +1000 \text{ Pa}]$ for class B) to consider that the tested ductwork complies with the airtightness class rating.

Certifying Airtightness class ratings

When it comes to ductwork systems intrinsic airtightness class, it is necessary to appeal to a third-party to get reliable ratings.

Third-party certification for a fair and objective comparison of the ratings

Third-party certification purpose is to make available reliable, comparable and transparent data.

As third-party certifier, Eurovent Certita Certification (ECC) has to fulfil impartiality, independency and integrity requirements. The ISO 17065 accreditation by national body COFRAC² guarantees that these requirements are met and provides as a solid international recognition thanks to the EA³/IAF⁴ agreements.

The certification process of a given Eurovent Certified Performance (ECP) programme is described in the dedicated documents which constitute a single, common baseline for the product evaluation rules and guarantee a fair treatment of the manufacturers. Indeed, these

² COFRAC certificate n°5-0517. Accreditation scope available at <https://www.cofrac.fr>

³ European accreditation <http://www.european-accreditation.org>

⁴ International Accreditation Forum <http://www.iaf.nu>

Table 1. Air tightness classification for metallic circular ducts according to EN 12237:2003 [5]

Air tightness class	Static gauge pressure limit (p_s) [Pa]		Air leakage limit (f_{max}) [$\text{m}^3 \cdot \text{s}^{-1} \cdot \text{m}^{-2}$]
	Positive	Negative	
A (worst)	500	500	$0.027 \times p_t^{0.65} \times 10^{-3}$
B	1000	750	$0.009 \times p_t^{0.65} \times 10^{-3}$
C	2000	750	$0.003 \times p_t^{0.65} \times 10^{-3}$
D (best)	2000	750	$0.001 \times p_t^{0.65} \times 10^{-3}$

documents are public, so any manufacturer can check that each of the certification process steps (product selection, testing, auditing, etc.) is conducted in accordance with the related procedure.

To enhance an objective comparison, the certified data are quantifiable values expressed in specific units which are stipulated in the certification programme documents. Besides, the certified data is available on-line⁵ 24/7, to anyone, without any registration or password.

The DUCT programme

The DUCT programme, into force since September 2016, opened a new chapter in the history of the Eurovent Certified Performance (ECP) certification mark, which concerned only products, not systems, until then.

To meet this challenge and ensure the programme content relevance, Eurovent Certita Certification worked for one year with a dedicated committee gathering six major European manufacturers of ventilation ducts and fittings. The development of the programme also involved consultation of European testing laboratories. The resulting rules are gathered in specific documents [7][8][9][10].

The scope of the programme covers rigid and semi-rigid ventilation ductwork systems divided into the following sub-programmes:

- Rigid metallic ductwork systems with circular cross-section (DUCT-MC);
- Rigid metallic ductwork systems with rectangular cross-section (DUCT-MR);
- Semi-rigid non-metallic ductwork systems predominantly made of plastics (DUCT-P);

The scope is restrained to ductwork systems made of elements (straight duct or fittings) fitted with an integrated sealing solution to guarantee a good level of intrinsic airtightness. Sealing solutions considered as suitable are listed in the rating standard of each sub-programme [8][9][10].

The product performance testing is conducted annually on a typical setup, common to all manufacturers within a given sub-programme, which varies from one year to the other (e.g. **Figure 3**). This typical set-up is defined by the DUCT project manager in accordance with the rules defined in the certification documents [7][8][9][10].

⁵ <http://www.eurovent-certification.com>

The test is conducted in accordance with EN 12237:2003 [5] for circular and semi-circular geometries (sub-programmes DUCT-MC and DUCT-P) or EN 1507:2006 [6] for ductwork systems of rectangular geometries (sub-programme DUCT-MR).

For the DUCT-P sub-programme, specific test pressures were defined by the Launching Committee as non-metallic ductwork products are not originally covered by EN 12237:2003 [5]. The certification documents will be updated according to upcoming unique test standard under preparation by CEN TC 156.

To ensure the performance ratings accuracy and reliability, the certification process relies upon product performance testing but also on production sites auditing which enables to verify that the tested object is representative of the whole production. Indeed, during the audit the auditor proceeds to the ductwork elements sampling and identifies them with his signature to guarantee that elements constituting the tested system are issued from regular production.

The audit is also the opportunity to verify key manufacturing requirements defined in the certification documents. For instance, a dimensional check shall be performed regularly enough to guarantee a proper matching of the elements to be assembled.

Audits are conducted annually on a number of local workshops (manufacturing straight ducts only) and fitting factories specified in the operational manual [7] to verify that the requirements are met at all times.

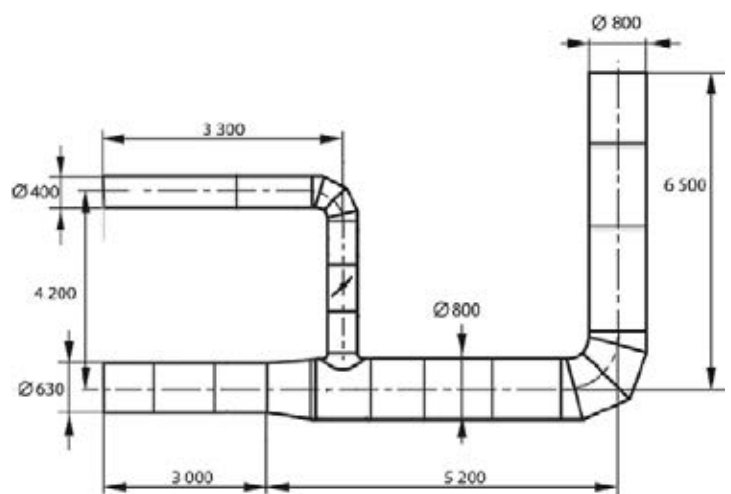

Figure 3. Example of typical ductwork system suitable for DUCT-MC sub-programme testing. Source [11]

How does the DUCT programme contribute to encourage better airtightness?

The goal of the ECP mark is to verify the rating accuracy, not to influence the market. This is why a ductwork system with airtightness class A can be ECP certified just as well as a ductwork system with airtightness class D. However, publishing certified ratings favours comparability of data so experienced showed for other certification programmes that the apparition of certified products on a market tends to raise the performance level.

Annual testing of the ductwork systems and auditing of production sites represent a great incentive for manufacturers to continuously improve their products, hence favouring better and better airtightness ratings.

The Eurovent Certified Performance (ECP) mark, is one the most renowned certification mark in the HVAC&R fields in Europe and beyond. It is estimated that 66% of HVAC&R products sold on the European market are ECP certified⁶. It is therefore expected

that the international outreach of the ECP mark will encourage manufacturers to participate to the DUCT programme and thus prove their products ability to constitute ductwork systems compliant with the advertised airtightness class.

Conclusions

Air tightness is a key lever towards a better energy efficiency of the ventilation system and, by extension, of the building. Besides, it contributes in achieving better Indoor Air Quality levels.

Energy regulations and energy performance programmes are progressively becoming more stringent, putting increasing pressure for better air tightness levels and enhancing justification to prove compliance.

Certification of ventilation ductwork systems airtightness is a new step towards a better assessment of airtightness levels, contributing to the pursuit of Nearly Zero-Energy Buildings and improvement of the Indoor Air Quality. ■

⁶ 2014 data valid for Chillers, Heat Pumps, Fan Coil Units, Heat Exchangers and Filters within the certified scope

References

- [1] Directive 2010/31/EU of the European parliament and of the Council of 19 May 2010 on the energy performance of buildings (recast)
- [2] Charrier, S.; Bailly, A. and Carrié, F.R. (2015) Building Airtightness in France : regulatory context, control procedures, results in Qualicheck factsheet 07
- [3] Andersson, J.; Carrié, F.R. and Wouters, P., (1999) Improving Ductwork - A Time for Tighter Air Distribution Systems. EU Project SAVE-DUCT, Brussels 1999.
- [4] European Standard EN 14134:2004 Ventilation for buildings. Performance testing and installation checks of residential ventilation systems
- [5] European Standard EN 12237:2003 Ventilation for buildings. Ductwork. Strength and leakage of circular sheet metal ducts
- [6] European Standard EN 1507:2006 Ventilation for buildings - Sheet metal air ducts with rectangular section - Requirements for strength and leakage
- [7] Eurovent Certita Certification - OM-19 (2016) - Operational Manual for the certification of Ventilation Ducts
- [8] Eurovent Certita Certification - RS-2C002MC (2016) – Rating Standard for the certification of Rigid Metallic Ductwork Systems with Circular Cross-section
- [9] Eurovent Certita Certification - RS-2C003MR (2016) – Rating Standard for the certification of Rigid Metallic Ductwork Systems with Rectangular Cross-section
- [10] Eurovent Certita Certification - RS-2C004P (2016) – Rating Standard for the certification of Semi-Rigid Non-Metallic Ductwork Systems predominantly made of Plastics
- [11] Guedel, A. Barles, P., CETIAT - Etanchéité des réseaux aérauliques - Guide pratique (2012)

Certifying the Fan Performance in Air Handling Units with a Wire-to-Air approach

The fan is known to be a key component in a HVAC-R device. In particular, the fan-related performances reliability is of prime interest for Air Handling Units (AHU) manufacturers. In order to improve the fan performance data reliability, Eurovent Certita Certification launched in July 2017 a new Eurovent Certified Performance (ECP) certification programme for fans intended to be used as Air Handling Units components. A “wire-to-air” approach was used as guiding principle to evaluate and compare fan technologies fairly and effectively. With the FANS certification programme, ECC expects to improve the level of confidence on the market as well as the insurance that ratings are displayed under the same conditions.

Certifying the fans for Air Handling Units

The Eurovent certification programme for Air Handling Units (AHU) has been running for many years now and it unfortunately appeared that some test failures resulted from fan related performances inaccuracies.

The fan is indeed a key component in an AHU. The fan is responsible for proper air circulation, providing the airflow rate and pressure required to compensate the pressure drop occurring in the AHU and related ductwork. If the fan does not perform as expected the AHU functioning is jeopardized and the power consumption can be drastically affected.

In order to improve the reliability of the fan performance data, and thereby provide peace of mind to AHU manufacturers when they declare their own fan-related performance ratings, ECC decided to establish a certification scheme for fans intended to be used as Air Handling Units components. Thus, after one year of work comprising meetings with AHU manufacturers



MARIE-CLÉMENCE BRIFFAUD

Project Development Engineer
Eurovent Certita Certification
mc.briffaud@eurovent-certification.com

and laboratories, a new Eurovent Certified Performance (ECP) certification programme dedicated to fans was launched in July 2017.

Laying the foundation for the ECP-AHU fan's certification scheme

Third-party certification for a fair and objective comparison of the ratings

The FANS certification was developed under a Eurovent Certified Performance (ECP) mark, which is the most renowned certification mark in the HVAC&R fields in Europe and beyond. It is estimated that 66% of HVAC&R products sold on the European market are ECP certified¹.

The same procedures and rules (product selection, testing, auditing, etc.) are applied to all manufacturers participating to the programme, guaranteeing that the products are evaluated the same way. Indeed, the FANS certification process is described in the certification programme documents [2][3] and these documents are public². Any manufacturer can therefore check that each of the certification process steps is conducted in accordance with the related procedure, which guarantees a fair treatment of the manufacturers.

¹ 2014 data valid for Chillers, Heat Pumps, Fan Coil Units, Heat Exchangers and Filters within the certified scope

² OM-22 and RS/1/C/001 available on-line at <http://www.eurovent-certification.com>

The final objective of the third-party certifier is to make available reliable, comparable and transparent data. To this extent, the certification programmes are developed in such a way that published certified data can be objectively compared.

To achieve the appropriate level of reliability, the FANS certification programme assesses the fan performance ratings accuracy and reliability thanks to product performance testing but also production sites auditing and operating software checking. This way the consistency between tested data and advertised data is ensured.

To enhance the comparability, the certified data are quantifiable values expressed in specific units which are stipulated in the certification programme documents [2][3]. Moreover, the list of certified products is available on-line 24/7, to anyone, without any registration or password.

Accreditation and approval from the CPPC as further guarantees

As third-party certifier, ECC has to fulfil impartiality, independency and integrity requirements. The ISO 17065 accreditation by national body COFRAC³ guarantees that these requirements are met and provides as a solid international recognition thanks to the EA⁴/IAF⁵ agreements.

The certification documents [2][3] were approved by the Certification Programmes and Policy Commission (CPPC) before publication. The CPPC is an independent body composed of manufacturers, technical and scientific experts but also end user representatives and national authorities.

A strong certification scheme towards reliable and transparent data

A wire-to-air approach

AHU fans can be supplied as separate components to be assembled. However, to evaluate and compare fan technologies fairly and effectively, all the components involved in the air stream generation that affect the fan performance should be accounted for, whether they are supplied separately, pre-assembled or fully-assembled. The principle of assessing the fan performance including all the fan components, from the electric wire to the air discharge, is known as the “wire-to-air” approach. This

“wire-to-air” approach was used as guiding principle for the FANS certification scheme.

To fulfil the “wire-to-air” principle, all the components that appear in the applicant/participant product catalogue have to be included in the tested fan assembly. Whenever a given component is not included in the catalogue a recommended complementary component is to be specified and its influence on the certified performance values is to be assessed in the operating software according to specific rules. This enables to ensure the consistency of the fully-assembled fan performance ratings.

Thus, the certified data will be systematically displayed in “wire-to-air mode”, even for not fully assembled fans thanks to default values specified in the FANS documents [2][3].

Two sub-programmes are implemented in order to distinguish basic assemblies (impeller + housing + ancillaries), corresponding to the FAN-I sub-programme, from complete assemblies (impeller + motor + drive + controller + support structure + ancillaries) corresponding to the FAN-C sub-programme. Ancillaries cover inlet/outlet finger guards and inlet connection (cone, ring, nozzle, etc.).

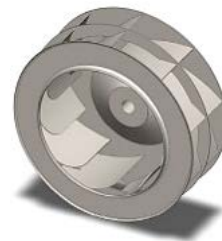

Figure 1. Illustration of a basic assembly. (source [4])

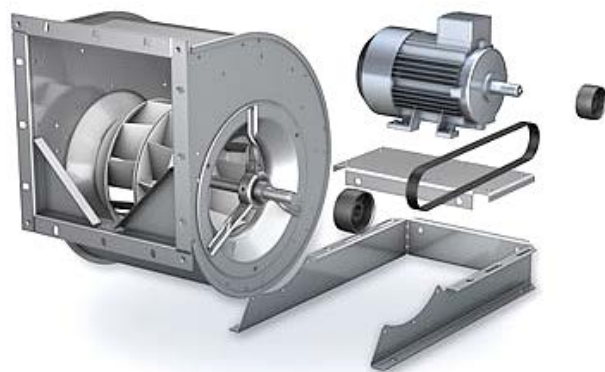

Figure 2. Illustration of complete assembly components. (source [5])

³ COFRAC certificate n°5-0517. Accreditation scope available at <https://www.cofrac.fr>

⁴ European accreditation <http://www.european-accreditation.org>

⁵ International Accreditation Forum <http://www.iaf.nu>

The sub-programme will appear on the certification diploma so that the end-user can know at a glance if the certified value corresponds to a fully-assembled fan or not. In any case the certified data is guaranteed to be conservative thanks to corrective coefficients and default values established in the FANS certification rules [2][3].

Product performance testing

Product performance testing is to be conducted annually in order to continuously check that compliance to the certification requirements is maintained.

In order to ensure the comparability, consistency and impartiality of the fan performance testing, at least two fans per range have to be tested in the independent laboratory selected and approved by Eurovent Certita Certification. Among other requirements, the independent laboratory must be ISO 17025 [9] accredited.

A total of six units per range (two copies of three different models) will be sampled from regular production during the audit (production line or stock) and authenticated (marked and sealed) by the auditor. The purpose of the selected units is indicated in **Table 1**. Once the test session is complete the manufacturer can get the units back.

The aerodynamic test, conducted in accordance with ISO 5801:2007 [7], enables to verify the performance ratings for 10 measuring points chosen by ECC within the fan operating area [3].

The acoustic test, conducted for complete assemblies (FAN-C sub-programme) in accordance with ISO 13347-2:2004 [8] enables to assess the acoustic behaviour of the fan when it operates at nominal rotational speed [3].

The certified data for both sub-programmes is summarized on **Table 2** and **Table 3**.

Capitalizing on existing efforts

On top of the tests in independent laboratory, the manufacturer shall provide to Eurovent Certita Certification the appropriate number of aerodynamic test reports (see Appendix 1 and Appendix 2).

As fans manufacturers may have already initiated efforts to improve the accuracy of their products performances (qualification of the factory test bench by an accred-

Table 1. Purpose of the units sampled and sealed by the auditor.

Unit	Action
Model A, copy 1	Sent to laboratory for regular test
Model A, copy 2	Sent to laboratory in case of component failure (regular test) or unit failure (second test) if any
Model B, copy 1	Sent to laboratory for regular test
Model B, copy 2	Sent to laboratory in case of component failure (regular test) or unit failure (second test) if any
Model C, copy 1	Sent to laboratory in case of unit failure (penalty test) if any
Model C, copy 2	Sent to laboratory in case of component failure (penalty test) if any

Table 2. Certified data according to the sub-programme – Aerodynamic test. (source [3])

Aerodynamic test	FAN-C	FAN-I
Overall pressure difference (static) [Pa]	✓	✓
Shaft power Pa, including bearings [W]	-	✓
Impeller efficiency η_r [%]	-	✓
Maximum fan speed N_{max} [rpm]	-	✓
Motor (electrical) input power P_e [W]	✓	-
Drive/control electrical input power P_{ed} [W]	✓	-
Overall efficiency η_e or η_{ed} (static; with or without VSD) [%]	✓	-

Table 3. Certified data according to the sub-programme – Acoustic test. (source [3])

Acoustic test	FAN-C	FAN-I
Inlet and outlet sound power level by octave bands between 125 Hz and 8000 Hz [dB]	✓	-

ited body, performance tests conducted by a laboratory organized according to ISO 17025:2005 [9], etc.), the FANS certification scheme includes specific criteria for the evaluation of existing aerodynamic test reports acceptability.

Among these criteria, the aerodynamic test reports shall be recent enough (less than three years for qualification and since last audit for surveillance) and a third-party shall be involved either in the test conduction itself or in the frame of the manufacturer's test bench qualification. To be acceptable the test reports shall also comprise essential information regarding measurement uncertainties and sensors calibration.

If the criteria are not met, the appropriate number of aerodynamic tests is ordered to the independent laboratory.

Appendix 1: Number of aerodynamic tests reports to be provided for qualification

For the qualification procedure the number of reports to be provided is calculated as follows:

For FAN-I (basic assembly) the applicant has to provide NFAN-I test reports and

$$N_{FAN-I} = N_{impeller}$$

For FAN-C (complete assembly) the applicant has to provide NFAN-C test reports and

$$N_{FAN-C} = \text{Max}(N_{impeller}; N_{motor}; N_{drive})$$

$N_{impeller}$ is the number of impeller tip diameters available in the range

N_{motor} is the number of motor sizes available in the range

N_{drive} is the number of drive types available in the range

Example: The range to be certified concerns centrifugal fans fitted with either a variable-speed drive or a multi-speed drive. There are nine (9) impeller tip diameters and six (6) motor sizes possible so

$$N_{FAN-C} = \text{Max}(9; 6; 2) = 9$$

Nine (9) models of fans will be selected in such a way that each impeller tip diameter, each motor size and each drive type is represented at least once.

Production sites auditing

Audits enable to verify that the products declared to certification are indeed the ones manufactured. The manufacturing process is also assessed to ensure that the tested object is representative of the whole production.

The auditor conducts an on-site checking of the software/DLL consistency, proceeds to the units sampling/sealing and verifies that applicable requirements are fulfilled.

The requirements comprise notably the proper use of the ECP mark when displayed on the production units or on documentation, the consistency between products declared for certification and observed in the sales record and/or production line and/or stock, the compliance of the quality management system to key criteria detailed in the certification documents, etc.

Audits are conducted annually to verify that the requirements are met at all times.

Software checking

As it is not possible to test each and every fan configuration (combinations of impeller size, motor type, drive type, etc.) at a reasonable cost, the number of tests is limited. To reach the appropriate level of confidence in the ratings for the whole range the tests are supplemented by audits and software checking.

Appendix 2: Number of aerodynamic tests reports to be provided for surveillance

For the surveillance procedure the manufacturer has to provide one (1) test report per production site.

If only part of the production sites is equipped with a validated test rig, the participant can either deliver the units to be tested to these particular sites or order the tests to Eurovent Certita Certification. In both cases the tested units will have to be traceable so that it can be evidenced that each of them comes from a different production site.

Example: If the participant has five (5) production sites that manufacture the certified ranges then a total of five (5) test reports shall be provided annually.

Specific requirements are foreseen in the FANS certification documents [2][3] for stand-alone software on the one hand and Dynamic Link Libraries⁶ (DLL), on the other hand.

The initial check, conducted remotely, enables to verify compliance to general requirements applicable to all ECP programmes [10] but also that the software/DLL ratings are consistent with the operating values (test conditions and measured performances) observed in the test reports provided by the manufacturer.

The software/DLL is also verified during the audit to check that the version sent to the certifier is the one indeed used for the orders treatment. To conduct this consistency, check the auditor selects two (2) orders at random from the manufacturer's sales records and runs the software/DLL. The design resulting from the computation must correspond to that provided to the customer.

Finally, Eurovent Certita Certification recalculates the ratings with the software (or DLL interface) according to the test operating conditions displayed in the test report ("test-check") so that the test results are compared to the appropriate ratings.

If all the checks prove the software/DLL consistency, the software version is certified, appears on the certificate and is published online⁷ together with the certified range references.

Conclusion

A new approach was used in order to certify the performances of fans integrated in AHUs: the "wire-to-air" approach. This principle consists in taking into account all the components, from the electric wire to the air discharge, that influence the performances of AHU fans. The implementation of such a "wire-to-air" principle in the FANS certification programme ensures that AHU fans are evaluated under the same conditions and that performance ratings are indeed comparable and transparent.

With the FANS certification programme, Eurovent Certita Certification expects to improve the level of confidence in the AHU fans performance ratings and thus provide to AHU manufacturers more reliable performance data, but also peace of mind since fans are considered as the most important component within AHUs in terms of energy efficiency. ■

⁷ <http://www.eurovent-certification.com>

Bibliography

- [1] Commission regulation (EU) No 327/2011 of 30 March 2011 implementing Directive 2009/125/EC of the European Parliament and of the Council with regard to ecodesign requirements for fans driven by motors with an electric input power between 125 W and 500 kW, 2011.
- [2] Eurovent Certita Certification - OM-22 - Operational Manual for the certification of fans, 2017.
- [3] Eurovent Certita Certification - RS/1/C/001 – Rating Standard for the certification of fans, 2017.
- [4] AirPro Fan & Blower Company - Backward curved fans [online]. <<https://airprofan.com/centrifugal-fans-blowers/backward-curved-fan>>, consulted on 14/11/2017.
- [5] Nicotra-Gebhardt website [online] <<http://www.nicotra-gebhardt.com>>, consulted on 14/11/2017.
- [6] ISO 13349 - *Fans-Vocabulary and Definitions of categories*, 2010.
- [7] ISO 5801 - *Industrial fans - Performance testing using standardized airways*, 2007.
- [8] ISO 13347-2 - *Industrial fans – Determination of fans sound power levels under standardized laboratory conditions - Part 2: Reverberant room method*, 2004.
- [9] ISO/IEC 17025 - *General requirements for the competence of testing and calibration laboratories*, 2005.
- [10] Eurovent Certita Certification - *Certification Manual of the Eurovent Certified Performance mark*, 13th edition, 2016.

Have your say on EPB standards' roll-out and join the practitioner's community!

AUTHORS: JAAP HOGELING, DICK VAN DIJK, EPB Center, Rotterdam, The Netherlands & ANITA DERJANECZ, REHVA, Belgium

How the EPB Center supports the dissemination and roll-out of the new Energy Performance of Building standards

Introduction

The set of CEN and CEN ISO Energy Performance of Buildings standards, developed under EC Mandate M/480 and published in 2017, provide EU Member States (MS) with a toolbox to help the implementation of the EPBD and aim also at higher transparency regarding the energy performance calculation methodologies. Each EPB standard has a template for a National Annex* that enables Member States to tailor the methodology to the national situation.

On September 21, 2018 a Service Contract was signed between DG ENER and a consortium led by ISSO to support the uptake of this set of EPB standards.

This 3-years' Service Contract will serve its purpose by:

- Providing support to Member States and National Standardization bodies as needed when preparing the National Annexes or National data sheets of the overarching EPB standards;
- Supporting the wide dissemination of the overarching EPB standards and their use by Member States (including as part of the obligations in Annex I of the revised EPBD);
- Setting up and running a public frequently asked questions database on developing National Annexes or data sheets, practical application of the standards, etc.
- Preparing practical case studies to support the use of EPB standards (e.g. use by industry stakeholders, researchers, international fora, financial institutions, etc.);
- Developing and disseminating calculation tools for individual EPB standards;
- Setting up a large network of current and future practitioners (i.e. building physics and HVAC students) and support the uptake of standards by organising regular hands-on workshops, webinars, online courses, etc.

The core part of the communication and dissemination is the EPB Center website (www.epb.center) acting as interface to and from the target groups, as well as a dedicated LinkedIn group.

The consortium

The consortium consists of a team of EPB experts and involved organizations, grouped around the EPB Center:

- Project leader: **Jaap Hogeling** (ISSO / EPB Center)
- REHVA: **Anita Derjanecz**: Workshops, webinars, communication
- NEN: **Annet van der Horn** (secr. of CEN/TC 371)

EPB experts:

- **Dick van Dijk**, The Netherlands (CEN/TC 89+371 & ISO/TC 163+205+TC 163/SC 2/WG15)
- **Dirk Van Orshoven**, Belgium (CEN/TC 371 + ISO/TC 163+TC 163/SC 2/WG15)
- **Laurent Social**, Italy (CEN/TC 228 + 371)
- **Gerhard Zweifel**, Switzerland (CEN/TC 156 +371 + ISO/TC 163+205)
- **Johann Zirngibl**, France (CEN/TC 228+371 + ISO/TC 205)
- **Jean Daniel Napar**, France (CEN/TC 247+371 + ISO/TC 205)

Activities in the first 6 months

To quick-start the exchange process, the prime concerns of the EU MSs will be identified and MSs will be engaged in the early stage of the project so that the project team can offer the best possible support that will help MSs in overcoming barriers, like questions raised on the National Annex approach or regarding the interpretation of particular EPB standards.

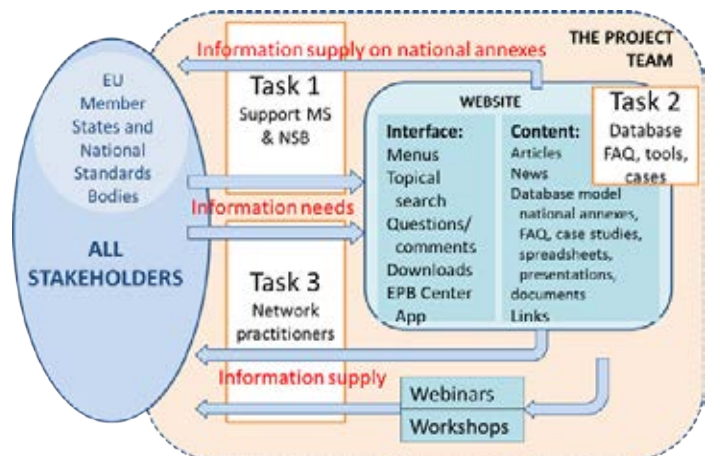

Figure 1. Illustration of the relation between the different activities in the project.

* See www.epb.center/implementation/national-annexes

Some outcomes of the first 6 months are:

- An informative report, a presentation and a brochure describing the state of play for the energy performance of buildings standards;
- A first version of FAQs and examples for filling the National Annexes and examples where EPB standards are applied or could be used (e.g. by industry stakeholders, researchers, financial institutions, etc.);
- A first draft for calculation tools for selected individual EPB standards including user guide, a presentation and examples of first case studies;

Description of the tasks

In line with the revised EPBD (2018), priority is given to the following ‘overarching’ standards: EN ISO 52000-1, EN ISO 52003-1, EN ISO 52010-1, EN ISO 52016-1 and EN ISO 52018-1.

These five ‘overarching’ EPB standards have in common that each of these describes an important step in the assessment of the energy performance of building:

Based on early feedback from the stakeholders, additional priorities are proposed by the project team. These deal with specific areas in the domain of the EPB standards describing the performance of the technical building systems that require special attention, because of their importance and complexity (see Figure 2).

Task 1: Support to Member States and National Standardization Bodies

Task 1 aims to reach out to Member States and National Standardization Bodies and support them in using the Energy Performance of Buildings standards. The main activity is to monitor and support the preparation and (intended) use of National Annexes or National datasheets to the EPB standards.

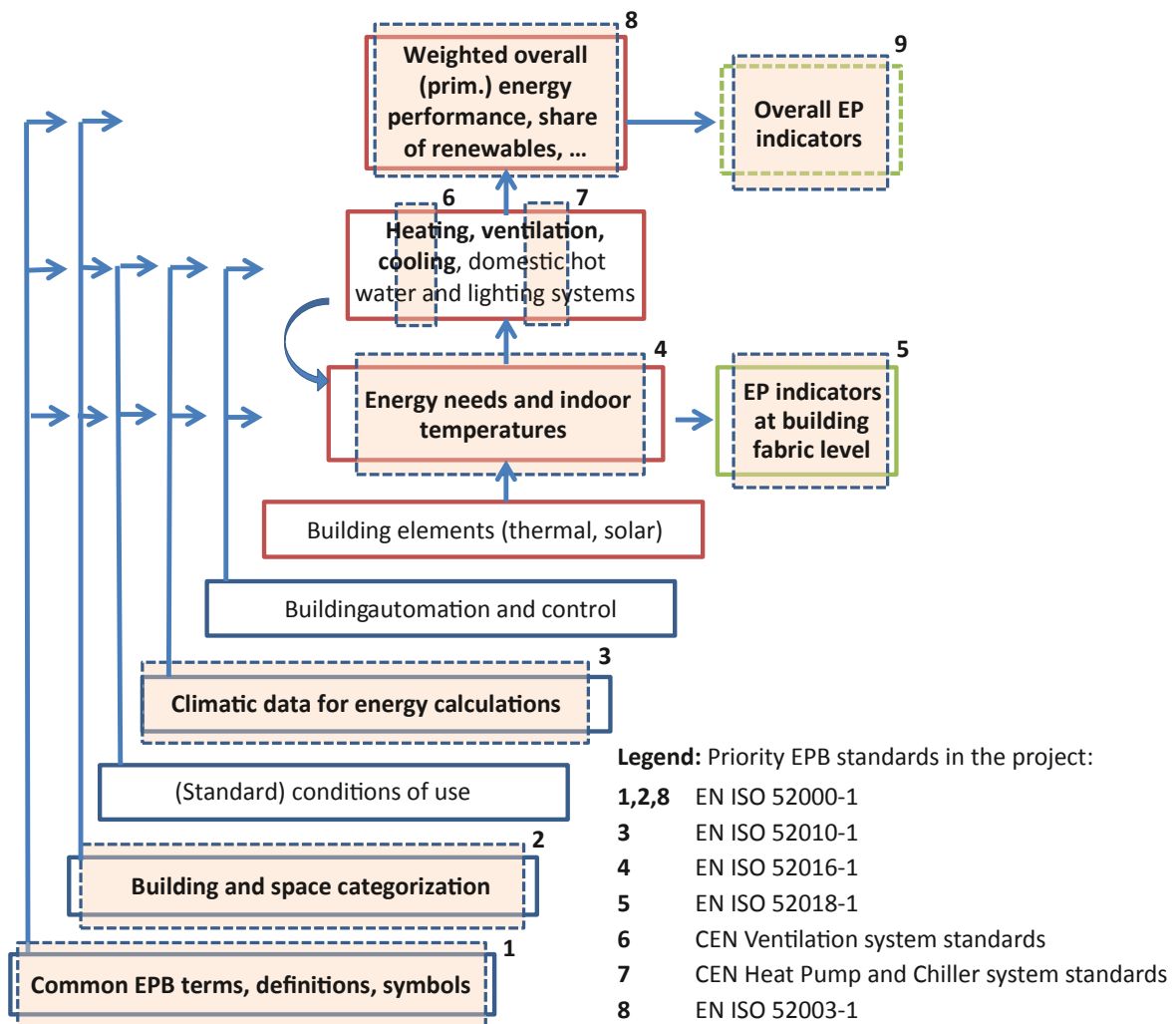

Figure 2. Flow chart in energy performance assessment and selected priority standards.

The EPB Center facilitates a platform of experts on the set of EPB standards with the aim of supporting member states in completing the National Annexes or National datasheets for the set of EPB standards.

Task 2: Setting up a database of FAQs, calculation spreadsheets and case studies

Database of Frequently Asked Questions

The main scope of the FAQs will be:

- the rationale behind and the rules for the National Annexes / National Datasheets,
- the completion of National Annexes / National Datasheets,
- the application of Annex I of the revised EPBD (2018): description of the national calculation methodology following the national annexes of the overarching standards,
- other issues related to national implementation,
- the technical content of the EPB standards,
- support tools (e.g. spreadsheets) and the case studies.

Calculation tools (e.g. spreadsheets)

In the M/480 mandate project (development of the set of EPB-standards), one of the tools to safeguard the necessary overall consistency and coherence for the set of EPB-standards, was the preparation of a spreadsheet for each EPB standard containing calculation procedures. In this Task 2 the spreadsheets of the earlier indicated priority standards will be updated.

Case studies

Partial Case studies:

- A few typical example buildings and climate data sets will be chosen as basis for the case studies.
- The example buildings and climatic datasets will be selected in such a way that they ensure a wide European climatic coverage. As a minimum, examples will cover:
 - Cold, mild and warm climate
 - Residential and non-residential buildings
- For each case, parameter variations will be prepared, to reveal the impact of the choice in input variables or in national choices on the output.
- As a rule, the (updated) spreadsheets will be used to prepare the case studies.

Simplified whole building cases studies:

In addition to these partial case studies, a few whole building case studies will be performed to demonstrate the overall usability of the set of EPB standards, e.g. with respect to the cost optimality calculations.

The envisaged case studies comprise:

- One single family house, new and existing
- One apartment building, new and existing
- One office building, new and existing

Because output data need to be transferred manually from one EPB standard as input to another EPB standard, a monthly method and other simplifications will be applied.

The main difference between the case for the new and the existing building is the availability of reliable input data.

Task 3: Creating a network of practitioners

Task 3 will include at least the following activities:

- Identification and targeted engagement of practitioner and stakeholder types.
- Cooperation with global and international organizations and networks.
- Set up of the network of practitioners (including organization of workshops, webinars and other events).
- **EPB Standards Academy:** information pool and capacity building platform with the following modules:
 - Webinars and online courses** tailored to different types of stakeholders, including MS level regulatory bodies and public administrators
 - Models and examples of National Annexes / National Datasheets:** to collect, compare and present National Annexes and National Datasheets that (are being / have been) prepared by MS's.
 - Information materials and fact sheets about the EPB standards:
 - EPB Case Study Database:

Concluding and asking feedback from EPB practitioners

The purpose of this article is not just to inform the REHVA Journal readers about this project: for the effectiveness of the project it is important to obtain early feedback from professionals involved or interested in the assessment of Energy Performance of Buildings and in the implementation of the related articles of the recently revised EPBD.

This feedback will help to adjust and tailor the planned activities in the project to the needs of the stakeholders.

The EPB Center activities are to plan, coordinate and guide the process of promoting the implementation and use, maintenance and further development of the set of EPB standards and safeguard the coherence of their technical content.

Other activities which are foreseen if sufficient interest can be organized are, for instance: improving the links between the EPB standards and ECODESIGN and further embedding of the EPB standards in the EN ISO set of EPB standards (ISO 52000 family of EPB standards).

All these activities aim to contribute to achieving uniformity, flexibility and sustainability as well as cost and risk reductions in the built environment. ■

Disclaimer

This article has been produced under contract with the European Union, represented by the European Commission (service contract ENER/C3/2017-437/SI2-785.185).

The information and views set out in this document are those of the author(s) and do not necessarily reflect the official opinion of the European Union. Neither the European Union institutions and bodies nor any person acting on their behalf may be held responsible for the use which may be made of the information contained therein.

Quality Management and Digitalization for Building Performance



STEFAN PLESSER

Dr.-Ing. Head of Energy and Quality Management Group, Institute for Building Services and Energy Design (IGS), Technische Universität Braunschweig, Braunschweig, Germany and Synavision Owner and Managing Director, Bielefeld, Germany



OLE TEISEN

Chief Consultant, Project Manager at Sweco, Copenhagen, Denmark

Quality Management and digitalization are two equally booming terms when it comes to building performance. And since the EU has decided to further promote building automation as an essential part of buildings with EPBD from 2025* on, the importance of both will most likely further increase. And for a good reason: both are urgently needed if we want to improve the energy efficiency of our building stock.

A tale of sustainability: To achieve a Gold-level certification, a building owner integrates energy efficient supply systems in his building like a CHP, a heat pump, a solar thermal collector and an absorption chiller. The low calculated energy demand grants additional credits for certification. Shortly after handover, he notices that some of the systems don't seem to work the way they should. It turns out that the management of the different systems is quite a challenge and had never really been specified in the design phase. Some systems can't even communicate with each other. After months of claim management and frustrating attempts to find out how the *system-as-a-whole* should work, the operation staff decided to keep the heating and cooling valves in a large air handling unit constantly open to create constant energy demand. The systems now run smoothly due to the continuous consumption of heating and cooling energy at the same time. And the owner lived disillusioned ever after.

Building performance

The case on the left below could be a joke, but unfortunately it is not. Furthermore, it is representing a common scenario where a lot of participants with good intentions don't have the understanding of the technical complexity of a modern building. In this article we try to outline some of the tools we can use to support proactive quality management instead of reactive quality assurance or even worse need for improvement as a result of the construction that does not meet the requirements of the owner.

Europeans spend more than 90% of their lifetime in the buildings. Therefore, indoor environment should be a priority for a design and operation. Since buildings also cause 35% of all CO₂-emissions, energy efficiency is no less important either. As a consequence, Europe has taken important steps towards better buildings. Today, innovative technologies allow high performance and nearly zero energy buildings providing excellent IEQ. Moreover, over the last years, ambitious building codes have been continuously asking for higher standards and lower energy consumption. As a result, energy consumption in operation of the new buildings has decreased – at least in some types of building and systems. At the same time a phenomenon has become evident: those new buildings with their ventilation and automation systems turn out to be rather complicated technical systems apparently being a huge challenge to designers, engineers, construction companies and facilities manager – and even to owners and users. As a consequence, the performance gap appeared: buildings do not work as intended. They miss their initial performance targets in operation. This is doubly costly: first the design and construction cause additional cost and then, later, operation cost are also higher than expected. This is an economic and ecologic no-go.

Solutions to this problem can be found in other industries: quality management. The term “Quality” is a colloquially often used to refer to a characteristic of an object or generally something “good”. In engineering, “quality” describes the degree, to which a set of inherent characteristics of an object fulfills requirements. Consequently, “quality management” is a process of supporting the fulfillment of requirements. Since today building suffers greatly from a performance gap, the bottom line is that we have a deficit in quality management for building performance.

* DIRECTIVE (EU) 2018/844 OF THE EUROPEAN PARLIAMENT AND OF THE COUNCIL of 30 May 2018 amending Directive 2010/31/EU on the energy performance of buildings and Directive 2012/27/EU on energy efficiency.

Quality Management and Digitalization for Building Performance

In 2012 a new 6,000 m² domicile was handed over from the design-build contractor to the owner. Various Danish media described the construction process as a success and all parties were satisfied with the result. The designers were particularly satisfied with the technical solutions:

- "Everything was tested before the building was put to service"
- The building achieved an architectural prize

Despite the fine words from all the dignitaries the employees working in the building kept complaining about the indoor climate. After the design professionals have tried to map the reason for the complains and after them the client advisor, a skilled Cx-team was invited to verify the indoor Climate. At this time, it is four years after hand-over.

The Cx team did the following observations and measurements:

- Unhealthy air
- Very varying air velocities in the working areas
- Too little supply of fresh air
- Poor distribution of the fresh air supplied from ventilation system
- Rapid rise of temperatures when the sun hits the facade

The ventilation system is designed as a Constant Air Volume system (CAV) despite meeting rooms operate with Variable Air Volume (VAV)

> Pressure oscillates in the air distribution ducts, the system can't obtain the values in the balancing report

No measuring points on hydronic systems

> Hydronic balancing is not possible

The story continues:

Ventilation system extracts air above ceiling without distribution ducts and Chill Beams are installed without following the requirements of the producer

> Draft

Architectural solution with windows in aluminum cassettes bolted to the outside of the facade

> Temperatures in the Cassettes up to 72°C, inner surface temperature measured on the glass 35–40°C

- Radiators are heating, also in the summer
- Solar screens operate after a control sequence that is not described
- The whole cooling system is running constantly – also in the winter – to keep IT-installations cold

Conclusion

- The owner's indoor climate requirements are not met
- Indoor conditions are so bad that it is not allowed to have employees working in the building
- 50% dissatisfied employees
- Energy consumption out of control
- Costly renewal of all technical installations and new cooling and ventilation concept necessitating new installations above ceilings and new ceiling system to be implemented while the building is in use

The Performance Gap

What is the performance gap that we aim to eliminate with quality management? It is often seen as energy consumption higher than budgeted. But energy is still cheap and for owners it is often much more serious if for example the indoor climate is negatively affecting the productivity of the employees. As you can read in the case above, the performance gap is a complex thing both to map and to handle. PhD student Helle Lohmann Rasmussen from Center for Facilities Management, DTU Management Engineering, Technical University of Denmark, has mapped various types of performance gap [1] in **Figure 1**.

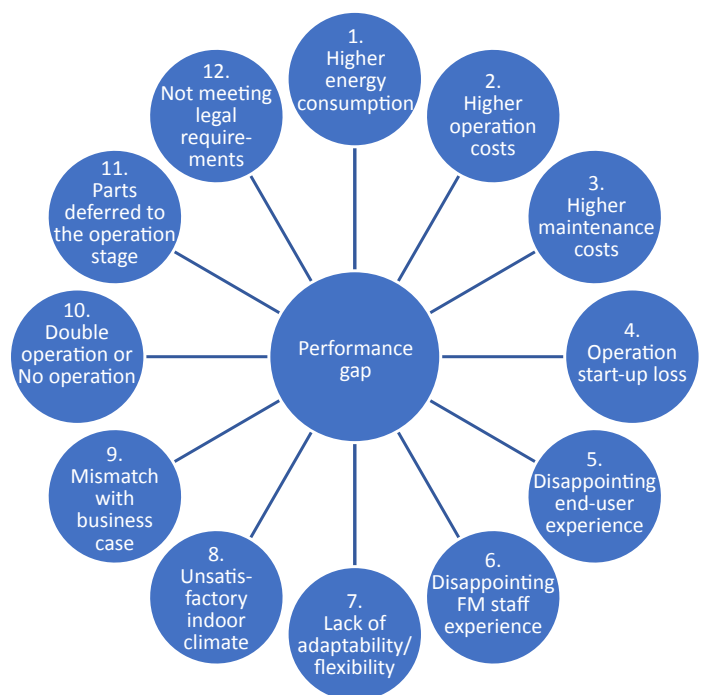

Figure 1. Figure A Facilities Manager's typology of performance gaps.

The complexity of buildings and the variety of causes for the performance gap indicate the challenge to implement an effective quality management.

Quality Management

Somehow, quality management is of course a part of any building. Construction needs verifiable calculations for their statics that are engineered and cross-checked, concepts for fire protection need to be defined in early design stages and should be tested before handover and every elevator is frequently being inspected. Usually, these tests are being carried out by a third party along well-defined testing procedures usually by technical experts for the very field.

Building performance as a whole though is not covered by an effective quality management process. In fact, well-defined third-party testing is often only applied in the still very rare buildings undergoing a certification process for sustainability, e.g. DGNB, HQE, BREEAM or LEED. They give credits for the application of certain quality management procedures.

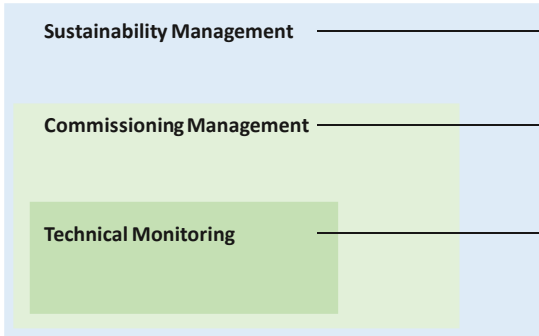

Figure 2. Quality management services as part of certification schemes.

Two of these procedures have evolved as particularly reliable and valuable services – even independently form certification schemes – and they are becoming increasingly popular: Technical Monitoring and Commissioning.

As a core aspect, both services have in common that they should be provided by an independent third-party that is explicitly not responsible for the design, construction and operation of the building. This independence is a prerequisite for the effective service and a transparent communication of any deficit detected by the quality management procedures.

Technical Monitoring (TMon)**

Technical Monitoring follows very closely the principal concept of quality by testing the fulfillment of

** The service is described e.g. by AMEV 135, VDI 6041 and also within the LEED certification as monitoring-based commissioning.

requirements and thereby establishing a quality control loop for building performance. The service focusses on the precise definition of requirements as the basis for quality management and the application of testing procedures for those requirements.

The quality control loop as defined for technical monitoring consists of four essential elements listed in **Table 1**.

Table 1. Phases of the quality control loop for technical monitoring.

Target values define measurable requirements for buildings and its systems. This may include the maximum level of CO₂-concentration in a conference room, the coefficient of performance of a chiller plant or the set point of a supply air temperature of an air handling unit at a certain ambient air temperature.

Measured values are the values obtained from building or system operation. The building has to be technically able to provide this data, e.g. via its building management system or additional metering devices. They need to precisely correspond to the target values.

Evaluation procedures. To be able to check whether a building fulfills its requirements, TMon applies evaluation procedures to compare the measured values versus the target values. Here it becomes apparent that both need to be defined very carefully to allow a meaningful evaluation: If one uses for example the overall energy consumption of a building as a target value, this value will be very uncertain due to assumptions in design as well as through the actual use of the building that is affected by – among others – tenants moving in step by step, changes in use and user behavior.

Actions. To actually improve building performance, TMon needs to communicate its findings effectively into the project. Any evaluation therefore needs to provide reliable and transparent results that can be delivered to engineers, contractors and maintenance personnel in time to be recognized and to allow appropriate response.

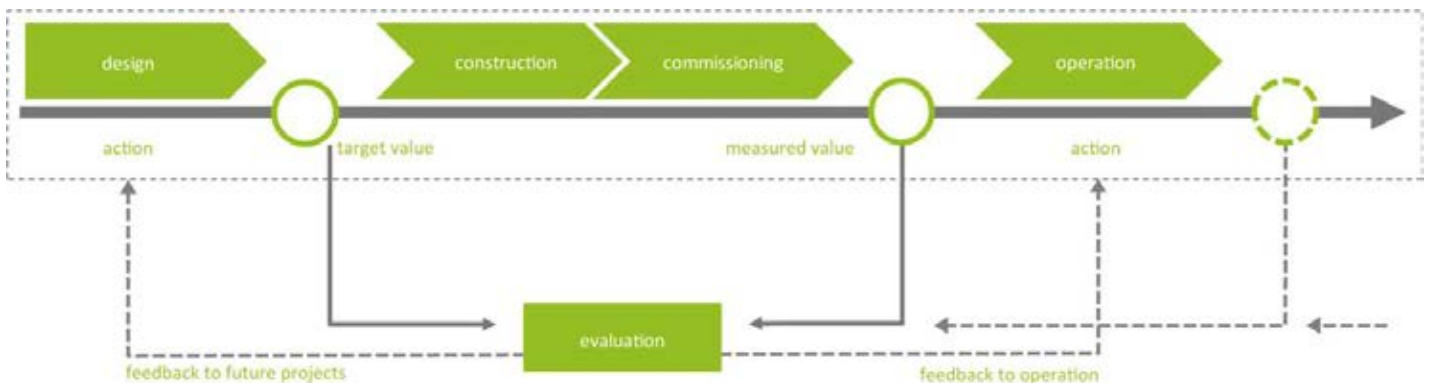

Figure 3. Quality Control loop.

If these four elements are implemented well into a building project, usually starting with the definition of “testable” requirements in the design phase, TMon can deliver a timely and very cost-effective support for any building project. In addition to the immediate control loop within a project, TMon also sets up a long tail loop: It allows to derive reliable experiences to learn for future projects.

Since TMon is based upon individual functional target values, it can be applied with an individually defined scope e.g. on individual systems and values. The option to choose an appropriate scope supports the cost effectiveness of the service.

Commissioning (Cx)

When we talk about Commissioning, we talk about a process. Commissioning is often misunderstood as “testing in the end”. The direct translation of the English word has led to many misunderstandings. It is therefore essential that we distinguish between the “event of commissioning” which means “starting up” and the “Commissioning Process” that consists of a sequence of activities spread throughout the construction process, from the pre-design phase to at least one year into operation.

Many building owners are asking “Why do I have to pay for Commissioning, has it not been included since the beginning of time?” The simple answer to that is: “Yes, the event of Commissioning has always been included, and it might also have been sufficient before, but with the complexity of today’s buildings, you have to do something extra”.

In **Figure 4** it is illustrated that faults, misunderstandings and demand for clarifications occur through the whole construction project and not only in the construction phase.

The Commissioning process starts in the pre-design phase and formally ends one year after completion. It does not take over any of the activities, that the designers and the contractors are already hired to do; they still have to manage the quality of their own delivery and balance their own installations.

Commissioning (Cx) follows a broader scope than TMon. In addition to the “pure” specification and testing within Technical Monitoring, Cx includes a variety of additional services ranging from checking the of design documents, operationability, for example the accessibility of air handling units for maintenance services to functional testing of systems (Life-cycle cost calculations are good tools for that), O&M documentation and supervision of building maintenance personnel training.

The Commissioning Process can be illustrated in a simplified manner as shown in **Figure 5**.

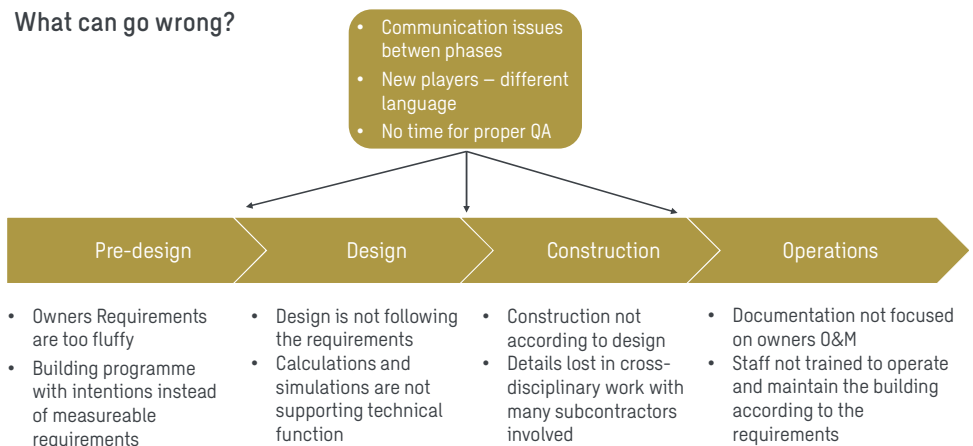

Figure 4. Possible causes of mistakes throughout the construction process.

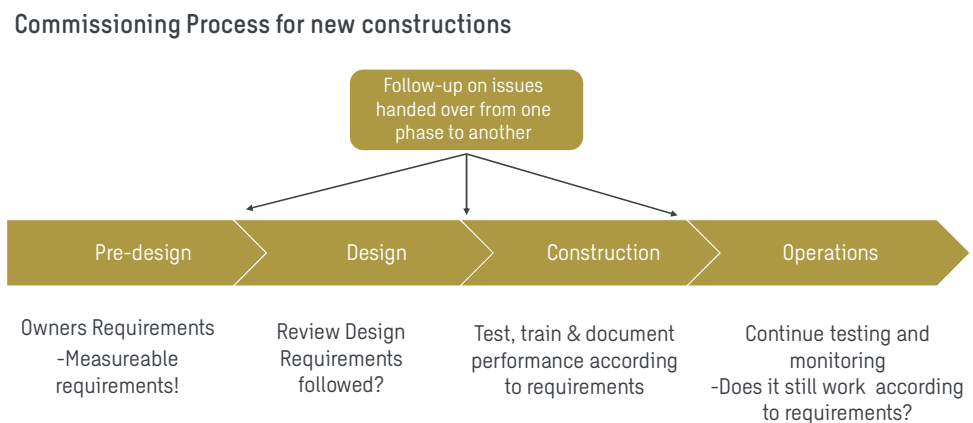
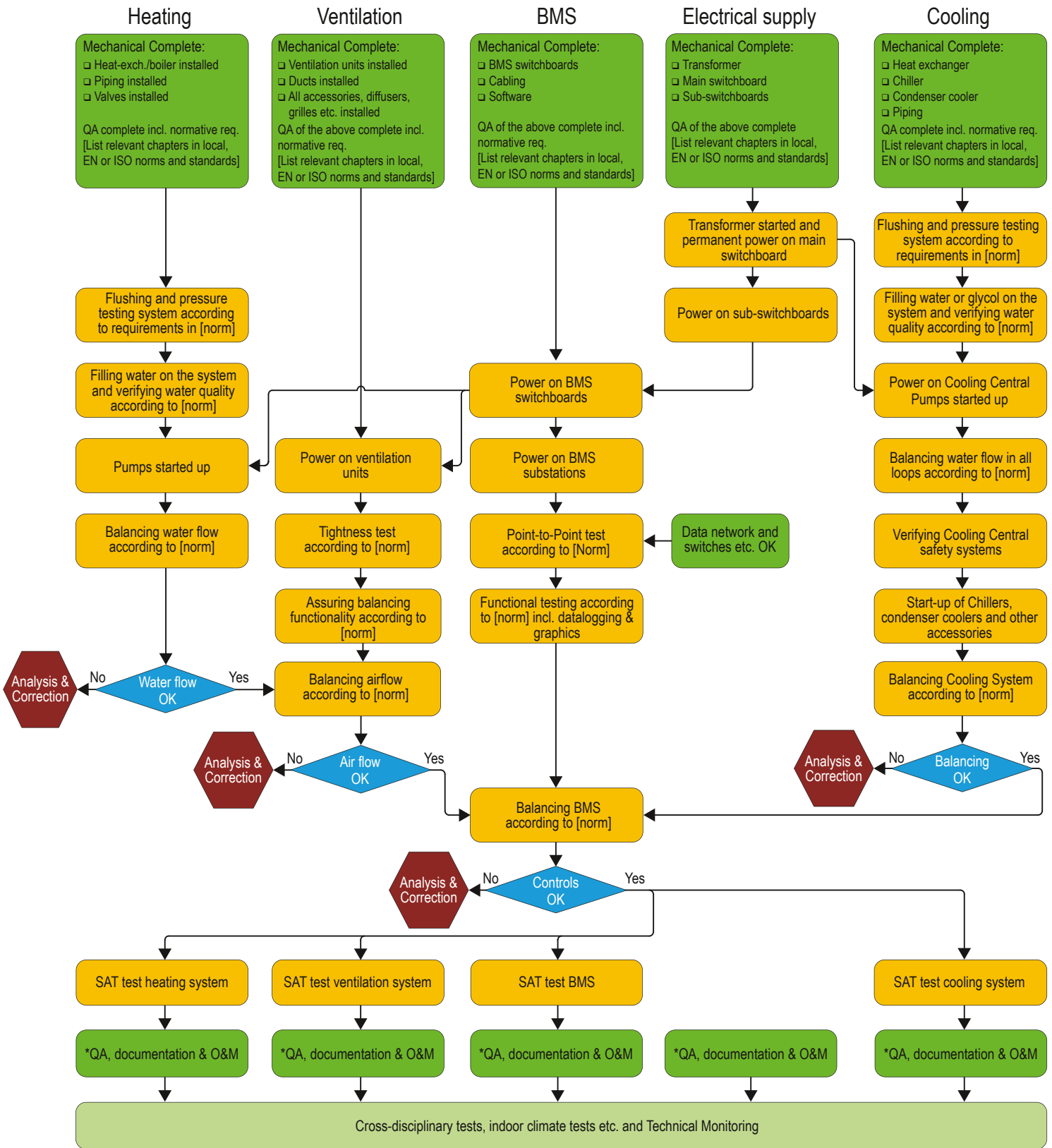

Figure 5. The Commissioning process made simple.

Flowchart interdependence between deliveries for typical HVAC start-up, balancing and verification



<ul style="list-style-type: none"> Prerequisite. Dark green boxes contains prerequisites. Documentation for fulfilled prerequisite must be shown. Contractor Action. Yellow boxes are actions with an accompanying document reporting the action. Acceptance. Blue diamonds show acceptance by the CxP. Issue. Red hexagons for issues to solve. Commissioning Action. Light green boxes are Cx or TM actions with an accompanying document reporting the action. 	<p>[Text in square brackets] refers to the corresponding norm. Local domestic norms must be activated, preferably related to EN, ISO or other international documents.</p> <p>*QA, documentation & O&M. All QA is completed. All issues solved and accepted by the commissioning provider. Documentation, drawings and descriptions exists. O&M exists.</p>
---	---

Figure 6. Pre-required data for technical monitoring and commissioning. [© Ole Teisen 2018, Sweco A/S]

The complete Commissioning Process typically consists of a facilitation of the owner to set up measurable requirements for the process, minimum of two operations-focused cross-disciplinary design reviews, sample performance testing of systems and indoor climate, planning of digital hand-over of O&M and documentation and planning of user training. In the operations phase the Commissioning Process continues as “On-going Commissioning” or “Monitoring-Based Commissioning”. Technical Monitoring should always be included as a core service of Commissioning.

In a popular way one could say that the Commissioning Process contains all quality management activities needed to facilitate and pass the tests of the Technical Monitoring.

To illustrate the complex relations and connections within modern buildings, **Figure 6** shows some of the prerequisites for TMon and Commissioning tests. It is very useful to include the tracking of all these QA documents listed here in the Commissioning Process to facilitate that systems are completed and quality assured before they participate in a cross-disciplinary test.

What is it worth?

The potential of a better quality as well as of TMon and Cx has been shown in numerous studies. For Technical Monitoring, that since 2017 in some German states is mandatory for public buildings, a study at Technische Universität Braunschweig [2] showed a return on investment of less than one year for Technical Monitoring. These numbers have been confirmed by about 250 TMon projects on more than 3,000 systems we did at synavision with our Digital Test Bench.

On commissioning, Evan Mills has analyzed 399 Commissioning projects, 322 on existing buildings and 22 on new constructions [3]. He found that the pay-back time for investment in a Commissioning Process that was 4.2 years for new constructions and 1.1 years for existing buildings. In the same study is found that the Commissioning Process costs ½–1% of construction costs. The study is renewed in the end of 2018. The own experience in Sweco is that pay-back time for new constructions are much lower than in the US. All the Commissioning projects the company has managed have paid back before hand-over in found deficiencies that would have been costly to redo later. Deficiencies are rooted in all stages of the construction process, and if they are found when testing and monitoring the completed construction, they usually are costly to fix. This can be illustrated by the curves in **Figure 7**.

Why it is important to start early



Figure 7. Deficiencies found when testing and monitoring the completed construction are usually costly to fix.

Digitalization

In the Commissioning Process, the hand-over of O&M documentation (and drawings, calculations, descriptions etc.) is usually handled through a digital tool. The typical and well-proven option is to enter all data related to O&M, QM, Balancing Reports, documentation, design and drawings together with the documents of the Commissioning Process in the owners CMMS (Computerized Maintenance Management System) system that then serves as the “Systems Manual” hosting every related documentation.

In Sweco we have now projects, where we link the Systems Manual (CMMS) and the building model. That opens up for help to find the precise location of a specific maintenance task generated in the system. You can also find the documentation for specific components and be guided into the building model to see in what locations the component is placed.

This linking between the Systems Manual and the Building Model is not very common yet, and we still need to see, if owners in the future will route sufficient resources to the FM staff to assure the maintaining and continuous update of the model and the link to the Systems Manual. But the digital approach is essential for quality management.

Although quality management services are principally available, there are barriers for their success. This became obvious through another quality management process: energy inspections for air conditioning system as required by EPBD. These inspections are mandatory in Germany since 2007 for every system with a cooling power of 12 kWth or more. The number of systems that have to be inspected is estimated to be about 250,000 [4]. So far not more than 10% of these systems actually have been inspected.

Buildings are becoming technically sophisticated systems. Therefore, as in other industries, **quality management** becomes an increasingly important part of the building process. Due to the complexity and uniqueness of buildings, **digitalization** – generally speaking the transformation of manual, human actions into data driven software-based processes – is a prerequisite to facility quality management. The first steps of this transformation started years ago when architects and engineers started to use computer aided design tools instead of pencils to create plans. Now the electronic design is to be further transformed into a digital building information model (BIM) containing information far beyond the physical shape of the construction like time of construction, product information and even ongoing metering data.

The reasons may be various: lack of owners' interest, lack of knowledge about the inspection duty, lack of control by authorities. But one reason is evident: The inspections usually require experienced experts to go on site and test the systems. These engineers simply do not exist! There is already a lack of engineers in the building industry so that additional services, if they are not exceptionally well paid, will have difficulties to succeed. Therefore, digitalization is an important opportunity for building performance. Not so much to cut cost but to enable quality management at all.

In this regard, TMon is of particular interest since the quality loop of defining target values, collecting measured data, evaluation it and communicating it to the project can be transformed completely into a digital service. One example is our Digital Test Bench at Synavision, which is currently proving its effectiveness within the EU funded Horizon 2020 project QUANTUM (www.quantum-project.eu). Our software as a service offers tools to digitally specify target values, import and evaluate data and produce a precise and transparent feedback. The software can be applied in new construction with a focus on the startup phase or in existing buildings e.g. for digital energy inspections. Due to the large extend of digitalization, the process does not require significant expert knowledge and in consequence can scale up massively and robustly.

Building performance needs to be improved in Europe. The technologies are already at hand. If we introduce quality management to ensure project success and if we use the new opportunities of digitalization, chances are good to turn the European building stock into a truly sustainable living environment.

Valuable sources of Commissioning Process knowledge

- IEA ECBCS Annex 47
- ASHRAE Guideline 0-2013
- ASHRAE standard 202
- BSRIA "Soft Landings"
- Danish Standard DS 3090
- LEED ver. 4
- DGNB Danish version Criterion 1.7 ■

References

- [1] Helle Lohmann Rasmussen (2018). A Facilities Manager's typology of performance gaps, Technical University of Denmark.
- [2] Stefan Plessner et al. (2018) „GA Spec&Check. Entwicklung und Erprobung einer Methodik zur Beschreibung, Abnahme und Überwachung von Funktionen der Gebäudeautomation“, Technische Universität Braunschweig.
- [3] Evan Mills Mills, E. P. (2009): Building Commission - A Golden Opportunity for Reducing Energy Costs and Greenhouse-Gas Emissions. California: Lawrence Berkeley National Laboratory.
- [4] Mai, Ronny (2016). "8 Jahre Energetische Inspektion von Klimaanlagen – ein Status Quo", ILK Dresden.

European Certification of HVAC&R products

Discover a top European Third-party certification body dedicated to guaranteeing worldwide consumers comfort and satisfaction via product performance certification.

Today, professionals face new challenges in complying with the objectives of carbon footprint reduction and addressing the constraints of building code regulations that require precise calculations based on performance data.

In addition, with the rising costs of energy and the growing demand for cooling in buildings, supermarkets, or data centers, monitoring energy consumption is becoming key to reduce both the financial and environmental impact.

In this challenging and fast-moving context, reliable product performance has become a main driver for business decisions and product investments. When it comes to reducing the energy bill, third-party certification offers a real value.

Trusted as a highly skilled and experienced partner, Eurovent Certita Certification has positioned itself as the number one Third-Party certification provider in Europe in the field of Indoor Climate, Ventilation and Air Quality, Process Cooling & Food Cold Chain.

Based on a voluntary scheme, our certification is open to all manufacturers as well as to distributors who can apply via our Brand Name scheme. We deliver independent and reliable expertise for residential, commercial, and industrial applications. We certify product performances according to both European and international standards, and our certification processes include yearly factory assessment audits, software audits, and third-party product testing.

Whether in response to the rapid growth of hybrid systems involving multiple energy sources or technologies, or to new directives and regulations, Eurovent Certita Certification's mission is to continuously adapt its programmes, methods, and protocols to meet the expectations of the market and its stakeholders.

The challenging normative and regulatory background in the fields of HVAC&R induces a complex environment. Assessing the quality and compliance of products is getting more and more difficult for end-users. In this context the Eurovent Certita Certification provides an easy and straightforward way to get up to date, trustful and exhaustive data.

Such information can be (and are already) used in various voluntary and regulatory compliance schemes.

With this special issue of the RHEVA journal, we welcome the opportunity to present our Third-Party performance certification expertise and know-how.



ERICK MELQUIOND
President
Eurovent Certita Certification

Consultants, buyers and contractors benefit from a fair and competitive market, supporting the dimensioning of energy efficient projects

Commercial buildings consume 40% of all electrical energy; with the introduction of the Energy Performance Building Directive (EPBD) in Europe, reducing energy consumption is one of the challenges consultants and contractors have to face. Dimensioning projects that assess the energy consumption of buildings and highlight its true cost quickly illustrate the power and value of certified data.

The mission of Eurovent Certita Certification is to create common set of criteria for rating products, that apply to all manufacturers, thus increasing the integrity and accuracy of data while ensuring the needed level of transparency to guarantee a fair and competitive comparison. With over 95,000 models certified, our database provides professionals with all the information needed to dimension equipment and match the technical constraints of the specifications with the financial target of the project.

Third-Party certification enables compliance monitoring to achieve environmental goals

Performance data certified by Eurovent Certita Certification is instrumental for State authorities to enable compliance monitoring. It provides valuable data to document and track market information. Eurovent Certita Certification is an accredited certification body, trusted to deliver a consistently reliable and impartial service which meets the appropriate, internationally recognised standards.

Third-party certification offers more than product testing

Integrity, Independence and Impartiality

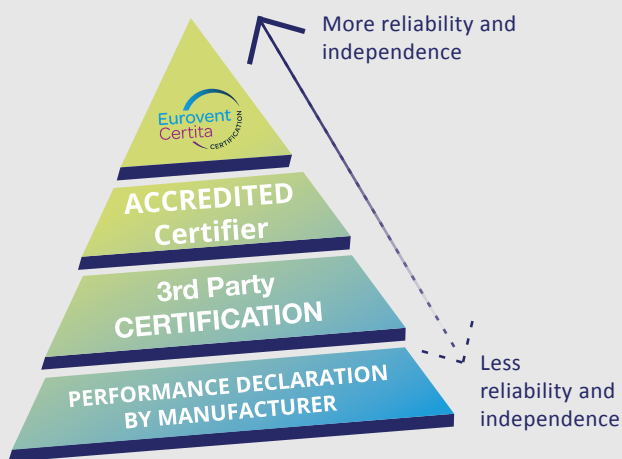

- We operate with the commissions responsible for the harmonisation and the integrity of our certification programmes, including authorities, end-user groups, scientific and technical bodies, and manufacturer associations.
- All 30 laboratories and testing agencies that are a part of the Eurovent Certita Certification process are regularly assessed according to ISO 17025. They are located in 11 countries worldwide.
- Our testing protocols include independent tests, manufacturing audits, selection software checks, product sampling, product purchasing, cross data coherence algorithms per product family, and product dismantling after testing.

Product performance certification delivered by Eurovent Certita Certification plays a key role to ensure transparency and deliver high quality and reliable data

Certified data can be used in many instances: tax incentives, national implementation of EPBD, building energy labels, green public procurements, white certificates. As certified performances provides confidence in the quality and the compliance of the products they can be required in voluntary schemes (e. g. building energy labels, green public procurements, white certificates) or being considered with an advantage over non certified products in regulatory schemes (e.g. national implementation of EPBD).

Example of such use can be found in the French Building energy efficiency calculation method which applies a penalty for non-certified heat-pumps and air to air heat exchangers. Consultancies use approved software in order to assess the compliance of a building with the French EPB regulation (RT 2012). These softwares are linked to database of products which are fed directly with Eurovent certified performance data.

2019: a new website and a fresh look with our online directory for a fair comparison of certified product performances

With more than 300 certified trademarks, and 50 000 references, all certified references and performances are listed in our online directory freely available www.eurovent-certification.com. For each product category, characteristics and certified performances are listed according to the same data structure and the latest European and international standards.

Coming soon... New certification programmes

Condensing units

In 2018 we successfully launched our certification programme for condensing units designed for commercial and industrial refrigeration applications. The scope is intended to include air-cooled condensing units as defined in regulation 2015/1095:

- integrating at least one electrically driven compressor
- integrating at least one condenser, capable of cooling down and continuously maintaining low or medium temperature inside a refrigerated appliance or system, using a vapour compression cycle once connected to an evaporator and an expansion device.

By a simple, 24/7 connection to our website

www.eurovent-certification.com

you can download **Product Performance Reports** that provide detailed performance features and values such as the **COP (Coefficient Of Performance)** or the **Sound Power Level**.

Range : FCL
MPS : 230-1-50
Diploma Nr. : 99.12.111
Mounting Base : Cassette

Model	Low speed (-)				Medium speed (-)				High speed (-)				General (-)			
	Pc kW	Ps kW	Ph kW	Qv m³/s	Pc kW	Ps kW	Ph kW	Qv m³/s	Pc kW	Ps kW	Ph kW	Qv m³/s	Pec W	Pec W	Pec W	Pec W
FCL132	1,16	0,99	1,33	-	35	10	1,47	1,22								
FCL32	1,16	0,99	1,33	-	35	21	1,47	1,22								
FCL132	1,16	0,99	1,33	-	35	10	1,47	1,22								

PRODUCT PERFORMANCE REPORT

Document ID 123110F50QK020454650FQ
Issued on April 27th, 2015

PROJECT IDENTIFICATION - This product performance report is delivered for:
Name MARCHÉ XXY
Company EUROVENT
Project reference CF23198
Project location PARIS

PRODUCT IDENTIFICATION
Certification Diploma N° 07-09-356
Manufacturer AIRWELL
Product reference 12231F32d51f3d5d3f131f3q1f3qdf1f3qdf1d3q3f13qf1q

Important notice:
I. Data featured in this report are valid at the date of issue. The scope of this product performance report does not include all certified data that can be checked in 12301.eurovent-certification.com.
II. This product performance report is valid only for above product features and should not be referred to as a Diploma.

FEATURE	VALUE	UNIT

Online product performance reports

All information available soon on our website www.eurovent-certification.com

Beverage coolers and plug-in refrigerated display cabinets

We invite all manufacturers and distributors of refrigerated display cabinets and/or beverage coolers to join our next launching committee where you will contribute to defining the rules to be applied to your equipment.

The **Launching Committee (LC)** oversees the specific requirements for product evaluation by preparing the relevant reference documents as well as guidance on the choice of laboratory.

Should you be interested in participating or just willing to get further information: Please contact us at d.bibalou@eurovent-certification.com ■

Exhibitions in 2019 – Come meet us

28-30 Jan	HVAC-R expo Saudi
7 Feb	EnerJ Meeting
13-15 Feb	BePositive
20-22 Feb-2	Refrigera
28 Feb-2 March	Acrex India
4-7 March	Climate World
11-15 March	ISH
12-13 March	Data Centre World
9-11 April	China Refrigeration Expo
26-29 May	Clima 2019
10-13 Sept	Febrava
2-5 Oct	ISK Sodex
5-8 Nov	Interclima
19-21 Nov	SIFA

Find all our information on our website: www.eurovent-certification.com

CERTIFICATION PROGRAMMES

FOR DOMESTIC, COMMERCIAL AND INDUSTRIAL FACILITIES

Indoor Climate

- Chilled Beams (CB)*
- Comfort Air Conditioners (AC)*
- European Heat Pumps
- Fan Coils Units (FCU)*
- Heat Interface Units (HIU)*
- Liquid-to-liquid Plate Heat Exchangers (LPHE)
- Rooftops (RT)*
- Variable Refrigerant Flow (VRF)*

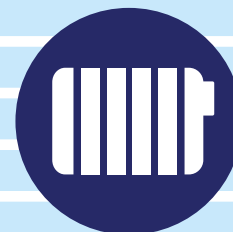

Ventilation & Air Quality

- Air Cleaners (ACL)
- Air Filters Class (FIL)*
- Air Handling Units (AHU)*
- Air to Air Plate Heat Exchangers (AAHE)*
- Air to Air Regenerative Heat Exchangers (AARE)*
- Fans
- Hygienic Air Handling Units (HAHU)
- Residential Air Filters (RFIL)
- Residential Air Handling Units (RAHU)
- Ventilation Ducts (DUCT)

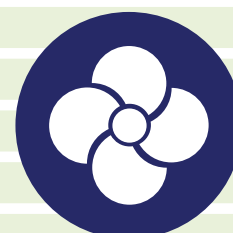

Process Cooling & Food Cold Chain

- Cooling & Heating Coils (COIL)
- Cooling Towers (CT)
- Drift Eliminators (DE)
- Evaporating Cooling
- Heat Exchangers (HE)*
- Heat Recovery Systems with Intermediate Heat Transfer Medium (HRS-coils)
- IT Cooling (ITCU)*
- Liquid Chilling Package & Heat Pumps (LCP-HP)*
- Remote Refrigerated Display Cabinets (RDC)

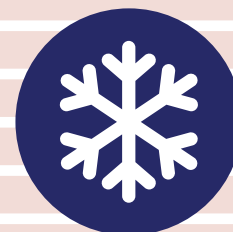

* All models in the production have to be certified

▼ Indoor Climate

Chilled Beams (CB)

CERTIFY
ALL

Scope of certification

This Certification Programme applies to all Active and Passive Chilled Beams. Chilled Beams are presented by ranges but all ranges must be certified. This applies to all product ranges which have either catalogue leaflets with product details including technical data or similar product information in electronic format.

Certification requirements

For the qualification procedure: 3 units are selected from regular production and tested in the independent Laboratory selected by Eurovent Certita Certification.

For the repetition procedures (yearly): the number of units selected is limited to 1 unit/range.

Obtained performances shall be compared with the values presented in the catalogues or electronic selection from manufacturer's website.

Certified characteristics & tolerances

Cooling capacity: 3 conditions are required.

- Active: 80 – 100 – 120% of the nominal air flow rate (for 8°C temperature difference)
- Passive: 6 – 8 – 10°C temperature difference

Tolerance = 12% and +24% for the 3 single values; -6% for the average value.

Water pressure drop: tolerance = maximum (2 kPa; 10%)

ECC Reference documents

- Certification manual
- Operational Manual OM-12
- Rating Standard RS 2/C/001

Testing standards

- EN 14518: "Testing and rating of Passive Chilled Beams"
- EN 15116: "Testing and rating of Active Chilled Beams"

Comfort Air Conditioners (AC)

CERTIFY
ALL

Scope of certification

This certification programme includes:

- AC1: comfort air cooled AC and air to air HP with cooling capacity up to 12 kW, except double duct and single duct units.
- AC2: comfort units with cooling capacity from 12 to 50 kW
- AC3: comfort units with cooling capacity from 50 to 100 kW

This programme applies to factory-made units intended to produce cooled air for comfort air conditioning (AC1, AC2, AC3). It also applies to units intended for both cooling and heating by reversing the cycle. AC1 programme units out of Regulation 206/2012 are excluded. AC2 and AC3 programme units out of Regulation 2016/2281 are excluded.

Participating Companies must certify all production models within the scope of the programme. For multi-split air conditioners, the number of indoor units is limited to 2, with same mounting type and capacity ratio 1 ± 0.05 . However, AC2 & AC3 units with 3 or 4 indoor units can be declared as an option.

Certification requirements

For the qualification & yearly repetition procedures: AC1: 8% of the units declared are selected and tested by an independent laboratory, and 30% of the selected

units are tested at part load conditions. AC2 & AC3: 10% of the units declared are selected and tested by an independent laboratory.

Certified characteristics & tolerances

- Capacity (cooling and heating) -5%
- Efficiency (EER and COP) at standard rating conditions and part loads: -8%
- AC1 Seasonal Efficiency (SEER and SCOP): -0% (automatically rerated when Part Load efficiency criteria fails)
- AC2 & AC3 Seasonal Efficiency (SEER/ η_{sc} and SCOP/ η_{sh}): -0% (automatically rerated when Part Load efficiency criteria fails)
- A-weighted sound power level +0 dB (A)
Auxiliary power +10%
- Minimum continuous operation Load Ratio: $LR_{contmin}$ [%], COP/EER at $LR_{contmin}$ and Performance correction coefficient at $LR_{contmin}$ $C_{cp}LR_{contmin}$.

ECC Reference documents

- Certification manual
- Operational Manual OM-1
- Rating Standard RS 6/C/001 • RS 6/C/001A • RS 6/C/006

Testing standards

- EN 14511 • EN 14825 • EN 12102

European Heat Pumps

The programmes AC, VRF, RT & LCP-HP also participate to the programme European Heat Pump

Scope of certification

- Electrically driven heat pumps for space heating (incl. cooling function)
- Electrically driven heat pumps used for heating swimming pool water (outdoors or inside)
- Dual-mode heat pumps, i.e. designed for space heating and domestic hot water production,
- Gas absorption heat pumps (incl. cooling function)
- Engine-driven gas heat pumps (incl. cooling function)

Certification requirements

- Qualification campaign: 1 test per range declared + 1 audit/factory
- Repetition campaign: between 1 and 3 machines/year (depending on the number of certified range) + 1 audit/ year/factory

Main certified characteristics & tolerances

- Heating and/or Cooling capacities P_h and/or P_c [kW], Electrical Power inputs P_e [kW] and Coefficient of performance COP
- Design capacity P_{design} , Seasonal Coefficients of Performance $SCOP$, $SCOP_{net}$ and Seasonal efficiency η_s
- Minimum continuous operation Load Ratio $LR_{contmin}$ [%], COP at $LR_{contmin}$ and Performance correction coefficient at $LR_{contmin}$ $C_{pLR_{contmin}}$
- Temperature stabilisation time t_b [hh:mm], Spare capacity P_{es} [W], Energy efficiency for water

- heating [COP_{DHW} & WH] or Global performance coefficient for a given tapping cycle COP_{global}
- Reference hot water temperature θ_{WH} and Maximum effective hot water volume V_{MAX} [l]
- Daily consumption for the draw-off cycle in question (Q_{elec})
- Annual consumption (AEC)
- Sound power levels L_w [dB(A)]

ECC Reference documents

- Certification manual
- Operational manual OM-17
- Rating standard RS 9/C/010

Main testing standards

Thermal performance:

- Heat pumps with electrically driven compressors
- Space heating & cooling: EN 14511-1 to 4; Seasonal performance: EN 14825
- Domestic hot water: EN 16147
- Direct exchange ground coupled heat pumps: EN 15879-1
- Gas-fired heat pump: EN 12309-1 to 5

Acoustics:

- Heat pumps and dehumidifiers with electrically driven compressors: EN 12102
- ISO 3741: Reverberant rooms or ISO 9614-1: Sound intensity, measurements by points

Fan Coils Units (FCU)



Scope of certification

This Certification Programme applies to Fan Coil Units using hot or chilled water. It concerns both non ducted and ducted fan coils:

- Non-ducted units: Fan Coil Units with air flow less than 0.7 m³/s and a published external static duct pressure at 40 Pa maximum.
- Ducted units: Fan Coil Units up to 1 m³/s airflow and 300 Pa available pressure.
- District cooling units and 60 Hz units can be certified as an option

Participating companies must certify all production models within the scope of the programme. Selection tools (software) are checked.

Certification requirements

Repetition procedure: the number of units to be tested each year will be proportional to the number of his basic models listed in the Directory, in an amount equal to 17% for Fan Coil Units with a minimum of one test.

Certified characteristics & tolerances

- Sensible capacity* **: -8%
 - Total cooling & heating capacity* **: -7%
 - Water pressure drop* **: +20%
 - Fan power input*: +10%
 - A-weighted sound power **: +2 dB(A)
 - Air flow rate: -10%
 - Available static pressure 0 Pa for medium speed and -5 Pa for other speeds
 - FCEER & FCCOP
 - Eurovent energy efficiency class
- (*) At standard and non-standard conditions
 (**) Tolerances for capacities are increased by 2% for variable speed units.

ECC Reference documents

- Certification manual
- Operational Manual OM-1A
- Rating Standard RS 6/C/002
- Rating Standard RS 6/C/002A

Testing standards

- Performance testing: EN 1397:2015
- Acoustic testing: EN 16583:2015

▼ Indoor Climate

Heat Interface Units (HIU)

CERTIFY
ALL

Scope of certification

The present certification scheme covers Heat Interface Units, defined as a packaged unit including at least one Domestic Hot Water heat exchanger and control elements.

The HIU may contain:

- An additional heat exchanger for heating
- Balancing elements
- 1 heating pump
- Metering possibilities

The HIU covered by the scheme are 3 pipes configurations. HIU with DHW capacity level above 70 kW are not covered by the certification scope. Only units for single family dwellings use are covered.

The covered technologies are:

- Domestic Hot Water technology only: HIU/DHW
- DHW and direct heating technology: HIU/DHW/DH
- DHW and direct heating mixed technology: HIU/DHW/DHM
- DHW and indirect heating application: HIU/DHW/IH

Certification requirements

The Heat Interface Unit certification program includes:

- Annual random selection of units and tests in an independent and accredited laboratory.

- Annual production site audit
- Unit labelling
- Certify-all principle

Certified characteristics & tolerance

- Maximal DHW capacity (kW)
- Return temperature during normal DHW tapping (°C)
- Minimal DHW flow rate (l/min)
- DHW reaction time (s)
- DHW Standby heat losses (kW)
- Capacity on temperature delta of 20 K (kW)
- Capacity on temperature delta of 10 K (kW)
- Difference between primary return temperature and secondary return temperature at 4kW (°C)
- Heat losses (kW)

ECC Reference documents

- Certification manual
- OM-26
- RS10/C/001

Testing standards

- Tests are conducted in accordance with the Test Regime Technical Specification, Rev-007 by BESA (Building Engineering Services Association), and in complement of testing specifications described in the Rating Standard RS/10/C/001.
- Units are both tested under High Temperature Conditions and Mid Temperature Conditions.

Liquid-to-liquid Plate Heat Exchangers (LPHE)

Scope of certification

This certification programme applies to plate heat exchangers designed for liquid/liquid heat exchange (without phase change) applications in the Heating Ventilation and Air Conditioning (HVAC) field and operated with clean water or clean water mixtures (ethylene/propylene glycol but also ethanol aqueous solutions).

The product categories covered are:

- Gasketed plate heat exchangers,
- Brazed plate heat exchangers
- Fusion-bonded plate heat exchangers

Certification requirements

The certification scheme is based on product performance testing by independent testing laboratories as well as manufacturing facility auditing and selection software checking.

For qualification (entry year): 1/4 of the models (4 models minimum) selected for testing + 1 audit/factory.

For the repetition procedure (annually): 1/10 of the models (2 models minimum) selected for testing + 1 audit/factory.

If more than 3 new models are introduced in the range during the declaration file annual update, then 1 extra test will be conducted.

The performances measured by the independent laboratory are compared to the selection software output data.

Certified characteristics & acceptance criteria

Capacity: $-(3\%+\mu)$

Pressure drop on primary fluid circuit: $+(10\%+\mu)$, minimum +2kPa

Pressure drop on secondary fluid circuit: $+(10\%+\mu)$, minimum +2kPa

With μ the expanded uncertainty calculated by the laboratory for the test in question (uncertainty analysis as per RS 7/C/010).

ECC Reference documents

- Certification manual
- Operational manual OM-25
- Rating Standard RS 7/C/010

Testing standards

Specific testing method in Rating Standard RS 7/C/010 notably based on, but amending, the following standards:

- EN 1148:1999+A1:2005
- EN 306:1997

▼ Indoor Climate

Rooftops (RT)

CERTIFY
ALL

The Eurovent rooftop certification (RT) program covers air-cooled packaged rooftop cooling only and reversible units below 100 kW (in cooling mode), with an option to certify air to air units from 100 kW to 200 kW and water-cooled packages rooftops.

The Rooftop program regroups 11 participants of which the five main European manufacturers.

Eurovent certifies indoor and outdoor sound levels, cooling and heating capacity and efficiency. Certified performances provide transparency and fair comparison between manufacturers. It is also the basis for the reliable study of HVAC system energy performance.

For two years the program has evolved towards tests at part load conditions in order to prepare the certification of seasonal efficiencies (SEER & η_{sc} , SCOP & η_{sh}) of which the publication on the Eurovent Certified Performance (ECP) website is expected for mid-2018.

It was a strong willing of manufacturers involved in the program to be completely in line with the new Eco design Regulation (N° 2016/2281) applicable from 1st of January 2018 for several HVAC products as the rooftop units.

The next challenges of the programme will be the taking into account of the free cooling for the cooling efficiency and the heat recovery mode for the 3 & 4 damper rooftops, but obviously, the software certification will be a key item to comply with existing and coming certification of building energy calculations in the EU countries.



Committee chair:
Mr Alain Compingt
Regulatory and External
Relationship, LENNOX EMEA



Mr Arnaud Lacourt
Head of Thermodynamics
Department, Eurovent
Certita Certification

Scope of certification

- This Certification Program applies to air-cooled packaged rooftop cooling only and reversible units below 100 kW (in cooling mode).
- Air to air units from 100 kW to 200 kW and water-cooled packages rooftops can be certified as an option.

Certification requirements

- For the qualification and repetition procedures (yearly) between 1 & 3 units are selected and tested, depending on the number of products declared.

Certified characteristics & tolerances

- Capacity (Cooling or Heating): -5%
- EER or COP: -8%
- Seasonal Efficiency in cooling: SEER & η_{sc}
Expected in mid 2018

- Seasonal Efficiency in heating: SCOP & η_{sh}
Expected in mid 2018
- Condenser water pressure drop: +15%
- A-weighted Sound Power Level: +3 dBA
- Eurovent Energy Efficiency class (cooling and heating)
- Eurovent Energy Seasonal Efficiency class.
Expected in 2019

ECC Reference documents

- Certification manual
- Operational Manual OM-13
- Rating Standard RS 6/C/007

Testing standards

- EN 14511 for Performance Testing
- EN 14825 for Seasonal Efficiencies
- EN 12102 for Acoustical Testing

Variable Refrigerant Flow (VRF)

CERTIFY ALL



Launched in 2013, the VRF programme started with a restricted scope: outdoor units up to 50 kW, testable combinations up to limited number of indoor units (2 cassettes or 4 ducted units). But it was a first step to increase the integrity of the products performances on the market.

From 2015, an annual factory audit has completed the requirements of the VRF programme.

From 2018, an extended scope is proposed:

- Outdoor units up to 100 kW
- Combinations up to 8 indoor units (cassette or ducted) depending of the outdoor unit capacity
- Certified seasonal efficiencies (according to Ecodesign Regulation No 2016/2281, applicable from 2018)

The VRF program has prepared this change during 2017, testing the first units at the part load conditions and extreme ambient temperature (up to -10 kW) in order to be able to publish from Mid-2018:

- certified SEER and η_{sc} for the cooling mode
- certified SCOP and η_{sh} for the heating mode

Early 2018, the VRF program regroups henceforth 15 participants of which the world's leading manufacturers.



Mr Arnaud Lacourt
Head of Thermodynamics
Department, Eurovent
Certita Certification

Scope of certification

The certification programme for Variable Refrigerant Flow (VRF) applies to:

- Outdoor units used in Variable Refrigerant Flow systems with the following characteristics:
 - Air or water source, reversible, heating-only and cooling-only.

VRF systems with data declared and published as combinations are excluded from the scope.

Heat recovery units are included in the scope but the heat recovery function is not certified.

High ambient systems are included in the scope but tested under standard conditions as specified in RS 6/C/008.

Certification requirements

- Qualification: units selected by ECC shall be tested in an independent laboratory selected by ECC.

- Repetition procedure: units selected from regular production shall be tested on a yearly basis.
- A factory visit is organized every year in order to check the production

Certified characteristics & tolerances

- Outdoor Capacity (cooling and heating): -8%
- Outdoor Efficiency (EER, COP) at standard rating conditions and part loads: -10%
- Seasonal Efficiency (SEER/ η_{sc} and SCOP/ η_{sh}): -0% (automatically rerated when Part Load efficiency criteria fails)
- A-weighted sound power level: 2 dB

ECC Reference documents

- Certification manual
- Operational manual OM-15
- Rating Standard RS 6/C/008

Testing standards

- EN 14511 • EN 14825 • EN 12102

▼ Ventilation & Air Quality

Air Cleaners (ACL)

Scope of certification

The scope of this new certification programme includes devices for collecting and/or destroying indoor air pollutants for residential or tertiary sector applications, such as:

- Devices equipped with a fan that circulates an air flow of between 15 m³/h and 1,000 m³/h
- Independent electrically-powered devices.
- Residential (domestic) and tertiary sector applications: bedrooms, living rooms, offices, waiting rooms, retail stores, etc.
- All types of technology: mechanical filtration, electrostatic filtration, plasma, ionization, UV-A or UV-C lamp, etc.

Certified characteristics & tolerances

At maximum operating speed:

- Purification efficiency: purified air volume flow rate for each pollutant category treated such as
 - Breathable particles suspended in the air
 - Gaseous pollutants (formaldehyde, toluene, etc.)
 - Microorganisms (bacteria and mould)
 - Cat allergen
- Energy efficiency: (purified air volume flow rate / absorbed electrical power).
- Recommended room area for each pollutant category.

At 1, 2 or 3 operating speeds:

- Device air circulation flow rate.
- **Energy:** absorbed electrical power.
- **Noise impact:** sound power level.

When tested in the laboratory the obtained performance data shall not differ from the declared values by more than the following tolerance values:

- Air circulation flow rate [m³/h]: -5%
- Initial purified air flow rate [m³/h]: -5%
- Sound power level [dB(A)]: +2 dB(A)
- Absorbed electrical power [W]: Maximum [+5%; +1 W]

ECC Reference documents

- Certification manual
- Operational manual OM-20
- Rating Standard RS/4/C/002
- NF-536

Testing standards

- NF B44-200:2016
- XP-B44-013:2009 may notably be used as a supplement in some particular cases identified in the NF-536 reference document.

Air Filters Class (FIL)

CERTIFY ALL



Today, people spend most of the time inside of buildings. Hence, indoor air quality is a key factor to human health. Air filters removing fine dust from the air stream are the key component in building heating, ventilation and air conditioning systems to supply air of the required cleanliness and to ensure a high level of indoor air quality. With the air filter certification program, reliable and transparent filter data are ensured to customers. On a yearly base, four different filters are selected out of the product range of each participant for testing at independent laboratories according to EN ISO 16890: 2016, verifying the initial pressure drop, the filter ISO class rating and the ePM1, ePM1,min, ePM2.5, ePM2.5,min and ePM10 efficiencies, as well as the energy efficiency class to Eurovent document 4/11. Additionally, with the new energy efficiency label, Eurovent provides valuable data to enable users to select the most energy efficient air filters.



Committee chair: Dr. Thomas Caesar
Head of Filter Engineering Industrial Filtration Europe
Freudenberg Filtration Technologies SE & Co. KG

Scope of certification

- This Certification Programme applies to air filters elements rated and sold as ISO ePM1, ISO ePM2.5 and ISO ePM10 according to EN ISO 16890-1:2016

referring to a front frame size of 592x592mm according to standard EN 15805.

- When a company joins the programme, all relevant air filter elements shall be certified.

Certification requirements

- For the qualification procedures: 6 units will be selected and tested by an independent Laboratory selected by Eurovent Certification.
Then each year 4 units will be selected & tested

Certified characteristics & tolerances

- Filter ISO class rating: no tolerance.
- Initial pressure drop: +10% + 5 Pa (minimum 15 Pa)
- ePM1, ePM1,min, ePM2.5, ePM2.5,min and ePM10 efficiencies: -7%-point
- Annual energy consumption +10% +60 kWh/a

ECC Reference documents

- Certification manual
- Operational Manual OM-11
- Rating Standard RS 4/C/001

Testing standards

- EN ISO 16890: 2016
- Eurovent 4/21

▼ Ventilation & Air Quality

Air Handling Units (AHU)

CERTIFY
ALL



Swegon has participated in the program for Air Handling Units from the start. The first priority at that time, and still is, was to find a way for fair competition. This is a long-term struggle we try to cover all aspects from manufacturing to software performance predictions and its agreement with tests. We discuss and take decisions about mandatory performance in software printout, rules for the energy labelling, how to test and what to apply in the, on site, auditor check. Customers should go for Eurovent certified products, to get reliable data, and then they can cut the main cost and take care of the environment by minimising the use of energy.



Committee chair:
Mr Gunnar Berg
Development Engineer, Swegon

Scope of certification

This Certification Programme applies to ranges of Air Handling Units that can be selected in a software. Each declared range shall at least present one size with a rated air volume flow below 3 m²/s. For each declared range, all Real Unit Sizes available in the software and up to the maximum stated air flow and all Model Box configurations shall be declared.

Participants shall certify all models in the selected product range up to the maximum stated air flow.

A range to be certified shall include at least one size with a rated air volume flow up to 3 m³/s.

Certification requirements

For the qualification procedure: the selection software will be verified by our internal auditor. A visit on

production site will be organized. During that visit, the auditor will select one real unit per range, as well as several model boxes that will cover all mechanical variations.

The selected units will be tested and performances delivered by the selection software will be compared to the performances measured in an independent laboratory.

For the repetition procedures, the auditor will annually check the software conformity against the production data, and tests will be repeated every 3 to 6 years.

Certified characteristics & tolerances

- External Pressure: 4% or 15 Pa
- Absorbed motor power: 3%
- Heat recovery efficiency: 3%-points
- Heat recovery pressure drop (air side): max. of 10% or 15 Pa
- Water coil performances (heating/cooling): 2%
- Water coil pressure drop (water side): max. of 10% or 2 kPa
- Radiated sound power level casing: 3 dB(A)
- Sound power level unit openings:
 - 5 dB @ 125 Hz
 - 3 dB @ 250 – 8 000 Hz
- Casing Air Leakage: same class or higher

ECC Reference documents

- Certification manual
- Operational Manual OM-5
- Rating Standard RS 6/C/005

Testing standards

- EN 1886: “Ventilation for buildings – Air handling units – Mechanical performance”
- EN 13053: “Ventilation for buildings – Air handling units – Rating & performance for units components and sections”
- RS/6/C/011-2016 Hygienic AHU

▼ Ventilation & Air Quality

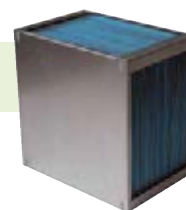
Air to Air Plate Heat Exchangers (AAHE)CERTIFY
ALL**Scope of certification**

This Certification programme applies to selected ranges of Air to Air Plate Heat Exchangers. Participants shall certify all models in the selected range, including:

- cross flow, counter-flow and parallel flow units
- all sizes
- all materials
- all airflow rates
- all edge lengths
- plate heat exchanger with humidity transfer

Heat Exchangers with accessories such as bypass and dampers shall not be included.

Manufacturers shall declare production places and provenance of products is randomly chosen. The programme does not cover other types of Air to Air Heat Exchangers like Rotary Heat Exchangers or Heat Pipes. Combination of units (twin exchangers) are also included in the scope of the program.

Certification requirements

For each range to be certified, 3 units for qualification and 1 for yearly repetition will be selected by Eurovent Certita Certification and tested in an independent Laboratory.

Certified characteristics & tolerances

- Dimensions: ± 2 mm
- Plate spacing: $\pm 1\%$ or ± 1 plate
- Temperature efficiency Dry: -3 percentage points
- Temperature efficiency Wet: -5 percentage points
- Humidity efficiency: -5%
- Pressure drop: $+10\%$, minimum 15 Pa

ECC Reference documents

- Certification manual
- Operational Manual OM-8
- Rating Standard RS 8/C/001

Testing standards

- EN 308

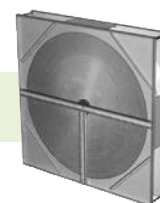
Air to Air Regenerative Heat Exchangers (AARE)CERTIFY
ALL**Scope of certification**

This Certification Programme applies to all ranges of Air to Air Regenerative Heat Exchangers (RHE) including sealing systems. Units sold without casing and sealing systems are also included. Participants shall certify all models in the ranges, including:

- all classes: condensation (non-hygroscopic, non-enthalpy) RHE, hygroscopic enthalpy RHE, hygroscopic sorption RHE
- all RHE geometry (wave height, foil thickness)
- all sizes (rotor diameters and rotor depths and surface areas of Alternating Storage Matrices - ASM)
- all materials
- all airflow rates
- all different types of sealing (if available)

Certification requirements

For the qualification procedures 1 unit per class of rotor will be selected and tested by an independent laboratory. For yearly repetition, 1 unit will be selected.

Certified characteristics & tolerances

- Temperature Efficiency: -3% points
- Humidity Efficiency: -5% points (min. tolerance 0.2 g/kg in absolute humidity of leaving supply air)
- Pressure Drop: $+10\%$ (min 10 Pa)
- Outdoor Air Correction Factor (OACF): 0.05
- Exhaust Air Transfer Ratio (EATR): $+1\%$ point

ECC Reference documents

- Certification manual
- Operational Manual OM-10
- Rating Standard RS 8/C/002

Testing standards

- EN 308
- ARI 1060

Fans

Scope of certification

This certification programme applies to the fans types that are intended to be used as Air Handling Units components.

Certification requirements

The certification scheme is based on product performance testing by independent testing laboratories as well as manufacturing facility auditing and selection software checking.

Two sub-programmes enable distinguishing performances certified for an impeller basic assembly on the one hand (sub-programme FAN-I) and for a complete assembly on the other hand (sub-programme FAN-C). In both cases, the fan assembly is evaluated in accordance with a wire-to-air approach. This approach consists in assessing the fan performance from the electric wire to the air discharge, accounting for all the components involved in the air stream generation that affect the performance data.

- For qualification (entry year) and repetition procedures (annually): 2 models (+ 1 extra model in case of confirmed failure) are selected from regular production and tested in independent laboratory + N aerodynamic test reports are provided by the applicant/participant.
- For qualification (entry year): $N = \text{Max}(N_{\text{impeller}}; N_{\text{motor}}; N_{\text{drive}})$ with N_{impeller} the number of impeller sizes; N_{motor} the number of motor sizes and N_{drive} the number of drive types available in the range.

- For the repetition procedure (annually): $N = N_{\text{factories}}$ with $N_{\text{factories}}$ the number of factories involved in the certified range production.

The performances measured by the independent laboratory (or available in the reports) are compared to the selection software output data.

Certified characteristics & tolerances

- Static pressure difference (-4% or -15 Pa)
- Shaft power, including bearings (FAN-I) (+3%)
- Impeller efficiency (FAN-I) (-5 percentage points)
- Maximum fan speed (FAN-I) (-5%)
- Motor (electrical) input power (FAN-C) (+3%)
- Drive/control (electrical) input power (FAN-C) (+3%)
- Overall (static) efficiency (FAN-C) (-5 percentage points)
- Inlet/outlet LWfc by octave bands at 125 Hz (FAN-C) (+5 dB)
- Inlet/outlet LWfc by octave bands for 250 Hz - 8000 Hz (FAN-C) (+3 dB)

ECC Reference documents

- Certification manual
- Operational manual OM-22
- Rating standard RS 1/C/001

Testing standards

- ISO 5801:2007
- ISO 13347-2:2004

▼ Ventilation & Air Quality

Hygienic Air Handling Units (HAHU)**Scope of certification**

This programme applies to hygienic ranges of Air Handling Units. As an option of the Certification programme for Air Handling Units, only an already ECP certified range is eligible for the hygienic option.

The hygienic aspect of the AHU is certified based on a 3 levels classification, each level declaring an AHU suitable for different application:

- Level 1: Offices, commercial buildings, schools, hotels
- Level 2: Hospitals
- Level 3: Pharmaceutical, food processes, white rooms

The previous list is not exhaustive and must be used as a reference only. Final customer/user who has complete and detailed knowledge of the building application shall decide which Hygienic rating level is appropriate.

Certification requirements

Same as in the Air Handling Unit programme.

Certification characteristics & tolerances**Services characteristics:**

The following services characteristics are certified.

1. Manufacturing
2. Maintenance

3. Quality Management System
4. IOM (Installation and Operational Manual)
5. Shipment

Hygienic characteristics:

The following hygienic characteristics are certified:

1. Materials
2. Casing performance
3. Components arrangement and performances (filters, coils, heat recovery systems, fans, humidifiers, dehumidifiers and silencers)

ECC reference documents**Certification manual**

- OM-5-2016-rev1
- RS/6/C/011-2016 Hygienic AHU

Testing standards

- RS 6/C/005-2016
- EN ISO 846:1997
- EN ISO 2896:2001
- EN 10088-3:2014
- EN 1993-1-2:2005
- DIN 1946/4-6.5.1:2008
- EN 779:2012
- EN 1822:2010
- EN ISO 12944-2:1998

Residential Air Filters (RFIL)

Scope of certification

The programme scope covers the particulate and combination (particulate and gas) filters used in a residential ventilation unit and for which the following applies:

- the rated maximum air flow rate is comprised between 70 and 1000 m³/h included;
- the initial efficiency ePM10 is higher than or equal to 50%;
- the initial efficiency ePM1 is strictly lower than 99%;
- the ratio between effluent and influent concentrations measured at time zero is strictly lower than 20% (for combination filters only, see Rating Standard RS/4/C/003 for further details).

The programme scope covers filters for which the face area is lower than or equal to 300 mm x 600 mm. For the RFIL programme, the certify-all requirement as defined in the Certification Manual is applicable from January 1st of 2020 (see Operational Manual OM-21 for further details).

Certified characteristics & tolerances

When tested in the laboratory the obtained performance data shall not differ from the declared values by more than the following tolerance values:

- Initial pressure drop values: +10%+Mt or +10 Pa +Mt
- Initial efficiency values: -5 percentage points (absolute deviation)
- Minimum efficiency values: -5 percentage points (absolute deviation)
- Filter ISO ePMx class reporting value: -5 percentage points (absolute deviation)
- Adsorption capacity: -10%

Nota : Mt means "measuring tolerance"

ECC Reference documents

- Certification manual
- Operational manual OM-21
- Rating standard RS/4/C/003

Testing standards

- Eurovent 4/22:2015 (particulate filters and combination filters)
- SO 11155-2:2009 (combination filters only)

Ventilation Ducts (DUCT)

Scope of certification

The programme scope covers rigid and semi-rigid ventilation ductwork systems divided into the following sub-programmes:

- Rigid metallic ductwork systems with circular cross-section (DUCT-MC);
- Rigid metallic ductwork systems with rectangular cross-section (DUCT-MR);
- Semi-rigid non-metallic ductwork systems predominantly made of plastics (DUCT-P)

Each sub-programme applies to ductwork systems fitted with integrated sealing solution as described in relevant Rating Standard.

Certification requirements

The certification programme is based on product performance testing by independent testing laboratories as well as production sites auditing.

Certification characteristics & tolerances

The product performance testing will enable the verification of the following ratings accuracy:

- Air tightness class (all sub-programmes)
- Positive and negative pressure limits (all sub-programmes)
- Dimensions (DUCT-MC and DUCT-MR)
- Minimum and maximum service temperatures (DUCT-P)
- Resistance to external pressure (DUCT-P)

ECC reference documents

- OM-19
- RS/2/C/002MC
- RS/2/C/003MR
- RS/2/C/004P

Testing standards

- Air leakage and strength testing:
 - EN 12237:2003 (DUCT-MC and DUCT-P)
 - EN 1507:2006 (DUCT-MR)
- Service temperature and resistance to external pressure (DUCT-P):
 - RS 2/C/004P-2016

▼ Ventilation & Air Quality

Residential Air Handling Units (RAHU)

CERTIFY
ALL

The objective of the Eurovent RAHU certification programme is, through tests performed by a third-party, to verify the performance of a unit bought somewhere on the open European market. It is important for the RAHU certification to use a unit out of the serial production – no special samples. For us, as a manufacturer, it pays to develop good products that deliver what we promise. By utilizing certified products, the designers' task is easier as they do not need to make detailed comparisons or perform advanced tests. Consultants, engineers and users can select a product and be assured that the catalog data is accurate.

Certification is important for a designer/consultant/end user:

- No unnecessary risks – they can only use products that deliver what they promise "Eurovent certified".
- Well-functioning systems – the product delivers the promised capacity and performance
- Safer calculations on energy consumption is expected



Mr. Tobias Sagström

Global Product Manager Residential at Systemair AB

Scope of certification

This programme applies to balanced residential AHUs (supply and exhaust) with heat recovery systems such as:

- Air-to-air **plate** heat exchangers
- Air-to-air **rotary** heat exchangers
- **Heat-pumps** with a nominal airflow below 1 000 m³/h.

Certification requirements

- Qualification test campaign: 1 test per heat recovery type.
- Repetition test campaign: 1 test every 2 years for each heat recovery type.
- Units are sampled directly from selling points.

Certified performances

- Leakage class
- Aerodynamic performances:
- Airflow/pressure curves
- Maximum airflow [m³/h]
- Electrical consumption [W]
- Specific Power Input SPI [W/(m³/h)]
- Temperature efficiency / COP
- Performances at cold climate conditions
- SEC (Specific Energy Consumption) in [kWh/(m².an)]
- A-weighted global sound power levels [dB(A)]

Tolerances

- Leakage class 0
- Airflow -10%
- Temperature efficiency -3%-point
- Temperature efficiency at cold climate -6%-point
- COP / EER -8%
- A-weighted global sound power levels +2dB(A)
- Electrical consumption +7%
- Specific Power Input SPI +7%
- Disbalance ratio 0

ECC Reference documents

- Certification manual
- Operational manual OM-16
- Rating standard RS 15/C/001

Testing standards

- European standard EN 13141-7:2010

Cooling & Heating Coils (COL)



Heating Cooling Coils (HCCs) which enable the conditioning of different zones and flexibility in application in buildings are generally employed in compact and central station AHU. To meet the required extra capacity in various processes, they are also used as heating or cooling devices.

With the application of these coils to high energy efficient heat recovery systems, the entire system becomes more compact as well as it avoids occupation of large spaces. Besides, they can be applied to Variable Air Volume (VAV) systems used for conditioning of hospitals, shopping centers and convention facilities.

The Certification programme for the HCCs has increased integrity and accuracy of the industrial performance ratings which provides clear benefits for end users who can be confident that the product will operate in accordance with design specifications. Also, by means of this certification programme users can collect reference data on the fundamental characteristics of the HCCs, such as capacity, pressure drop, mass flow complying with the standard of EN 1216.

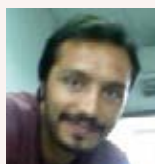

Engin Söylemez, R&D
Test Engineer, Friterm A.Ş

Scope of certification

The rating standard applies to coils operating:

- with water or with a 0–50% ethylene-glycol mixture, acting as cooling or heating fluid.
- and without fans.

Certification requirements

- Qualification and repetition procedures: units declared will be selected and tested by an independent laboratory.
- The number of units will depend on the variety of coil material configurations and their applications for the applied range.
- The selection software will be verified in comparison with the test results.
- On-site audits (checking of software)

Certified characteristics & tolerances

- Capacity: –7%
- Air side pressure drop: +20%
- Liquid side pressure drop: +20%

ECC Reference documents

- OM-9
- RS 7/C/005

Testing standards

- EN 1216:1998+A1/2002

Drift Eliminators (DE)

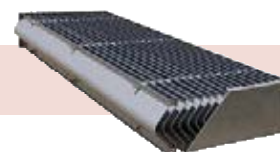

Scope of certification

The Certification Programme for Drift Eliminators applies to Drift Eliminators used for evaporative water-cooling equipment.

Certified characteristics & tolerances

The following characteristics shall be certified by tests:

- For counter-flow and cross-flow film fill, the average drift losses of the two tests at 3.5 m/s are less than 0.007% of circulating water flow rate.
- For cross-flow splash fill, the average drift losses of the two tests at 3 m/s are less than 0.007% of circulating water flow rate.

No tolerance will be applied on the average drift losses.

ECC Reference documents

- Certification manual
- Operational Manual OM-14
- Rating Standard RS 9/C/003

Testing standards

- CTI ATC-140

▼ Process Cooling & Food Cold Chain

Cooling Towers (CT)

The importance of air conditioning and industrial cooling is constantly increasing in modern architecture and industrial process cooling. The human perception of comfort and the new challenges to reduce the electrical power consumption and CO₂ foot-print have designers striving for optimal system performances with the highest possible efficiencies. Reliable thermal performances are crucial to ensure these best efficiencies which are typical for cooling circuits driven by evaporative cooling equipment. On a yearly basis, one random picked cooling tower of each Eurovent-CTI certified product line will be full scale thermal tested by applying the CTI standard 201.

Eurovent Certita Certification guarantees the consistency of thermal testing and manufacturing of European and non-European companies that subscribe to the program.



Committee chair:
Mr Rob Vandenboer
Product Manager, Quality Manager
Evapco Europe, BVBA

The first ECC / CTI collaborative certification program for Cooling Towers

The Eurovent Certification Company (ECC, Brussels, Belgium) is pleased to announce the Certification programme for cooling tower thermal performance developed in cooperation with the Cooling Technology Institute Est.1950 (CTI, Houston, Texas, USA). The scope of the program includes standardized model lines for open circuit cooling towers, typically factory assembled. Standardized model lines are composed of individual models that are required to have published thermal rating capacities at corresponding input fan power levels.

Thermal performance certification via this program offers a tower buyer assurance that the capacity published for the product has been confirmed by the initial and on-going performance testing per the requirements of the program using CTI STD-201. It also offers for regulators of energy consumption related to cooling towers, that the capacity of the towers has been validated. Mini-mum energy efficiency standards such as the Eurovent Industry Recommendation / Code of Good Practice Eurovent 9/12-2016 and ASHRAE 90.1, which requires cooling tower energy



efficiency validation by the CTI certification process, are used by governments and by green building certification programs such as LEED™.

Scope of certification

This Certification Programme for Cooling Towers applies to product ranges (or product lines) of Open-Circuit series and Closed Circuit Cooling Towers that:

- Are manufactured by a company whose headquarter or main facility are located in Europe, Middle-East, Africa or India. After getting the Eurovent Certification, the CTI certificate could be requested.
- Have already achieved and hold current certification by the Cooling Technology Institute (CTI) according to CTI STD-201.

Certification requirements

For the qualification & yearly repetition procedures our internal auditor visits the production place and reviews the conformity of Data of Records. One unit per range is selected and tested by an independent test agency.

Certified characteristics & tolerances

- Certified characteristic shall be per CTI STD-201
- Entering wet bulb temperature: 10°C to 32.2°C (50°F to 90°F)
- Cooling range > 2.2°C (4°F)
- Cooling approach > 2.8°C (5°F)
- Process fluid temperature < 51.7°C (125°F)
- Barometric pressure: -91.4 to 105.0 kPa (27" to 31" Hg)

ECC Reference documents

- Certification manual
- Operational Manual OM-4
- Rating Standard RS 9/C/001

Testing standards

- CTI STD-201 RS
- ECC OM-4-2017

Evaporating Cooling

Scope of certification

The programme for Evaporative Cooling is divided in three sub-programmes, as it applies to Evaporative Cooling units in the following groups:

- Direct Evaporative Cooling (DEC)
 - Indirect Evaporative Cooling (IEC)
 - With primary outside air
 - With separation of external and room air
- Evaporative Cooling Equipment (ECE)
 - Water spray system
 - Wet media
 - Ultrasonic unit

Certification requirements

All products of a declared range that fall into the relevant sub-programme scope and are promoted by the Applicant/Participant shall be certified. This is a certification by range.

The certification programme is based on product performance testing by independent laboratories as well as manufacturing facility auditing. In the case of

the IEC sub programme, the tests will be performed in the laboratory of the manufacturer supervised by an expert from an independent laboratory.

Certified characteristics & tolerances

- Cooling Capacity (all sub-programmes)
- Air flow (all sub-programmes)
- Efficiency (all sub-programmes)
- Water consumption (all sub-programme)
- Wet and dry pressure drop (ECE only)

ECC Reference documents

- Certification manual
- Operational Manual OM
- Rating Standard RS 9/C/004-005-006

Testing standards

- For direct evaporating cooling
AS 2913-2000 standard RS9/C/004
- For indirect evaporating cooling
ANSI/ASHRAE Standard 143-2015 RS9/C/005
- For evaporating cooling equipment
ASHRAE 133-2015 RS9/C/006

Heat Recovery Systems with Intermediate Heat Transfer Medium (HRS-COIL)

Scope of certification

This certification programme covers the heat recovery exchangers with intermediate heat transfer medium corresponding to the category IIa (“without phase change”) of the EN 308:1997 standard, that is Run Around Coils systems.

Certification requirements

Qualification procedure

- Product performance testing:
 - 1 coil per BMG to be selected
 - Selected coils paired into systems (1 “exhaust” coil + 1 “supply” coil)
- Operating software checking
- Audit of the manufacturing facilities

Repetition procedure:

- Product performance testing: 1 system to be selected (1 “exhaust” coil + 1 “supply” coil)
- Operating software checking
- Audit of the manufacturing facilities

Certification characteristics & tolerances

- Dry heat recovery efficiency [%]
- Air side pressure drop at standard conditions for each coil [Pa]
- Fluid side pressure drop for each coil [kPa]

When tested in the laboratory the obtained performance data shall not differ from the recalculated values (“test-check”) by more than the following tolerance values:

- Dry heat recovery efficiency: –3 percentage points (abs. deviation)
- Air side pressure drop: Maximum [+10%; +15 Pa]
- Fluid side pressure drop: Maximum [+10%; +2 kPa]

ECC reference documents

- Certification manual
- OM-18
- RS 7/C/009

Testing standards

- EN 308:1997

▼ Process Cooling & Food Cold Chain

Heat Exchangers (HE)

CERTIFY ALL



The purpose of the Eurovent “Certify-All” certification programme for heat exchangers is to encourage honest competition and to assure customers that equipment is correctly rated.

The programme covers 3 product groups:

- Unit Air Coolers
- Air Cooled Condensers
- Dry Coolers

The “Certify-All” principle ensures that, for heat exchangers, all models in the three product categories are submitted for certification, not just some models chosen by the manufacturer.

A product energy class scheme has been incorporated into the certification program, based on 6 classes from “A+” to “E” in order to provide a guide to the best choice of product: this enables the user to minimize life-cycle costs, including running costs which account for a much superior sum than the initial investment cost.

EVOLUTIONS OF THE PROGRAMME:

Extension of the scope of certification programme for Heat Exchangers

- to CO₂ applications. Implementation in 2019
- to NH₃ applications



Committee chair:
Stefano Filippini
Technical manager - LUVÉ

Scope of certification

The Eurovent Certification Programme for Heat Exchangers applies to products using axial flow fans. The following products are excluded from the Eurovent Certification Programme for Heat Exchangers:

- Products units using centrifugal type fans.
- Units working at 60 Hz

In particular, the following products are also excluded from the certification programme for Dx Air Coolers and Air Cooled Condensers:

- Product ranges of Dx Air Coolers with maximum standard capacity SC2 below 1.5 kW
- Product ranges of Air Cooled Condensers with maximum standard capacity under TD1 15 K is below 2.0 kW



Air coolers for refrigeration



Dry coolers



Air cooled condensers

Certification requirements

- Qualification: units selected by Eurovent Certita Certification shall be tested in an Independent Laboratory selected by ECC
- Repetition procedure: units selected from regular production shall be tested on a yearly basis.

Certified characteristics & tolerances

- Standard capacity –8%
- Fan power input +10% with a minimum of 3 W
- Air volume flow ±10%
- Dimensions and number of fins: Finned length ±0,5%, with a minimum of 5 mm
 - Height of the coil ±5 mm
 - Depth (width) of the coil ±5 mm
 - Total number of fins* ±4%, at least 2 fins
 - Diameter of (expanded) tube outside the coil* ±1 mm
- (*) *except for the micro-channels*
- Energy ratio R
- Energy class

For Dry Coolers:

- Liquid side pressure drop +20%

For Air Cooled Condensers and Dry Coolers:

- A-weighted sound power level: +2 dB(A)

ECC Reference documents

- Certification manual
- Operational Manual OM-2
- Rating Standard RS 7/C/008

Testing standards

- Thermal Performance EN 328
- Thermal Performance EN 327
- Thermal Performance EN1048
- Acoustics EN 13487

IT Cooling Units (ITCU)

CERTIFY
ALL

Scope of certification

The present certification programme covers IT Cooling Units specifically designed and used to regulate air temperature and optionally air humidity of an enclosed space containing critical equipment such as IT equipment or telecommunication equipment.

The IT Cooling technologies considered in the scheme are Computer Room Air Conditioners Direct Expansion (CRAC) and Computer Room Air Conditioner Chilled Water (CRAH). HYBRID technologies pairing these technologies are also covered by the scope as an option.

The IT cooling units must be factory made units designed as a single packaged unit or a single split unit. Units must be 50 Hz frequency units, optionally 60 Hz units can be declared in addition to the 50 Hz. The units can be ducted or non-ducted units, as well on the air return or on the air supply. Floating floors air return or supply are considered as a duct.

Certification requirements

- Annual random selection of units and tests in an independent and accredited laboratory
- Annual production site audit
- Software certification extending the certification from standard functioning conditions to non-standard conditions

Certified characteristics & tolerances

- Net Total Cooling Capacity (kW)
- Net Sensible Cooling Capacity (kW)
- Power input (kW)
- Net EER Energy Efficiency Ratio (%)
- Net SHR Sensible Heat Ratio (%)
- Water pressure drop (Pa)
- Supply Air Flow (m³/h)
- A-weighted sound power indoor side (dB(A))
- A-weighted sound power radiated by duct (dB(A))
- A-weighted sound power outdoor side (dB(A))

ECC Reference documents

- Certification manual
- OM 23
- RS/C/012

Testing standards

- EN 1451:2018
- EN 1397:2015
- ANSI/ASHRAE Standard 127-2012
- ASHRAE Standard 37
- EN 12102:2013
- EN 16583:2015

▼ Process Cooling & Food Cold Chain

Liquid Chilling Package & Heat Pumps (LCP-HP)CERTIFY
ALL

The historical ESEER, first seasonal efficiency for cooling, created in 2007 by Eurovent Certita Certification, and deeply recognized on the European Market is living its last moments.

With the implementation of the new Ecodesign Regulation No 2016/2281, the year 2018 will be a crucial year for the chillers industry. The European Market has to change its reference efficiency and turn towards SEER and η_{sc} , the new seasonal efficiencies for cooling mode.

The LCP-HP program has prepared this change since 2 years, testing yearly a significant number of units at the new part load conditions in order to be able to publish from January 2018, certified SEER and η_{sc} . The SEER has to become the new reference also for the certification program.

Moreover, the scope of the program has been extended for 2018:

- Previously limited to 1500 kW, the water-cooled chillers above 1500 kW can be henceforth certified in option, up to the maximum capacity of the manufacturer laboratory.
- The 4 pipe units can be certified also in option.

Although the program was originally attended for comfort chillers, it is important to remind that process chillers and their SEPR can also be certified as an option.

Lastly, face to these recently regulatory changes for the industry, the certification will be always a strong way to guaranty the reliability of our declared performances to our clients.



Committee chair:
Mr Rafael Berzosas
Water Cooled Chillers Product Manager
Trane Europe, Middle East & Africa

According to the last Ecodesign Regulations (No 811/2013 - No 813/2013 – No 2016/2281) the programme proposes the certification of Seasonal efficiency for heating (η_s & SCOP) for Chillers & Heat pumps with a design capacity below 70kW, Seasonal efficiency for cooling (η_{sc} & SEER) for all comfort

chillers and the seasonal energy performance ratio (SEPR) for process chillers.

Scope of certification

- This programme applies to standard chillers and hydronic heat pumps used for heating, air conditioning and refrigeration.
- They may operate with any type of compressor (hermetic, semi-hermetic and open) but only electrically driven chillers are included.
- Only refrigerants authorized in EU are considered. Chillers may be air cooled, liquid cooled or evaporative cooled.

Can be certified as an option:

- Heating-only hydronic heat pumps, 60 Hz units, 4-pipe units, Air-cooled units between 600 kW and 1500kW,
Water-cooled units above 1500 kW.

Certification requirements

Qualification and repetition: a certain number of units will be selected by Eurovent Certita Certification and tested every year, based on the number of ranges and products declared.

Certified characteristics & tolerances

- Cooling & heating capacity, EER & COP at standard rating conditions, TER : < -5%
- Seasonal efficiencies SCOP & η_s : automatically rerated when Part Load efficiency criteria fails
- Seasonal efficiencies SEER & η_{sc} : automatically rerated when Part Load efficiency criteria fails
- Seasonal efficiency SEPR: automatically rerated when Part Load efficiency criteria fails
- A-weighted sound power level: > +3 dB(A)
(> +2 dB(A) for units with $P_{designh}$ below 70 kW)
- Water pressure drop: +15%

Testing standards

- Performance testing: EN 14511
- Seasonal Performance testing: EN 14825
- Sound testing: EN 12102

ECC Reference documents

- Certification manual
- Operational Manual OM-3
- Rating Standard RS 6/C003 – RS 6/C/003A

Remote Refrigerated Display Cabinets (RDC)



CERTIFY ALL

Remote refrigerated display cabinets (RRDC) are the appliances for selling and displaying chilled and/or frozen foodstuff to be maintained within prescribed temperature limits.

Typically, food and beverage retailers are the direct customers of the refrigeration industry while the supermarket's customers are the end users of food and beverage retailers.

Food and beverage retailers ask for food safety and also for appliances with high-energy efficiency, supermarket's customers ask for food safety. Refrigeration industry has to face the hard challenge of satisfying both needs.

How is it possible to assure that the refrigeration appliances perform accurately and consistently to the reference standards? How is it possible to assure that what is rated by the manufacturer is properly rated?

There is only one way: It is necessary to join a globally recognized and industry respected certification program.

Eurovent Certita Certification program for RRDC is the only certification program in Europe that can assure that performance claims have been independently measured and verified. The factory audits and the product's performances tested in an independent and third-party laboratory make the difference!

Since 2011, Eurovent Certita Certification has also launched a voluntary energy label certification scheme, anticipating what only nowadays EC DG Energy is doing in the framework of Ecodesign and Energy Label Regulations. What better way to rate RRDC's energy consumption and to promote their energy efficiency?

What would you trust more: a self-declaration by the Manufacturer or what an independent, globally recognized and forerunner certification program is able to assure? Which one is better?



Maurizio Dell'Eva
Project manager
EPTA S.p.A. – MILANO (ITALY)

Scope of certification

- 100 basic model groups divided in 5 categories of remote units: semi-verticals and verticals (with doors); multi-deckers; islands; service counters; combi freezers.
- At least two references per basic model group representing 80% of sales shall be declared.
- One Bill of Material for each declared reference.

Certification requirements

- Qualification: sampling and test of one unit & Audit of one factory.
- Repetition test of one unit per brand every 6 months & Annual audit of each factory.

Certified characteristics & tolerances

- Warmest and coldest product temp. $\pm 0.5^{\circ}\text{C}$
- Refrigeration duty (kW) 10%
- Evaporating temperature -1°C
- Direct elec. Energy Consumption (DEC) +5%
- Refrigeration elec. Energy Cons (REC) +10%
- M-Package T_{class} : $\pm 0.5^{\circ}\text{C}$
- Total Display Area (TDA) -3%

ECC Reference documents

- Certification manual
- Operational Manual OM-7
- Rating Standard RS 14/C/001

Testing standards

- EN ISO 29953 and amendments



Send information of your event to Ms Giulia Marengi gm@rehva.eu



Events & fairs in 2019

Exhibitions 2019

27 February - 1 March	WSED 2019	Wels, Austria	www.wsed.at/en
28 February - 2 March	ACREX 2019	Mumbai, India	www.acrex.in
5-7 March	Futurebuild	London, UK	www.futurebuild.co.uk
1-5 April	BET - Building Energy Technologies 2019	Berlin, Germany	
17-20 April	teskon+SODEX 2019	Izmir, Turkey	http://www.teskonsodex.com/en
6-8 May	ISH China & CIHE	Beijing, China	https://ishc-cihe.hk.messefrankfurt.com/beijing/en.html
3-5 September	ISH Shanghai & CIHE	Shanghai, China	https://www.hk.messefrankfurt.com/content/ishs_cihe/shanghai/en/visitors/welcome.html
2-5 October	ISK-SODEX 2019	Istanbul, Turkey	www.sodex.com.tr/en

Conferences and seminars 2019

27 February - 1 March	WSED 2019 - European Energy Efficiency Conference	Wels, Austria	www.wsed.at/en/programme/european-energy-efficiency-conference.html
27-28 March	AIVC workshop	Dublin, Ireland	
8-10 May	CIAR - Congreso Iberoamericano de Aire acondicionado y Refrigeración	Santiago de Chile, Chile	
24-25 May	International Buildair Symposium	Hannover, Germany	
26-29 May	CLIMA 2019	Bucharest, Romania	www.clima2019.org/congress/
17-21 June	EUSEW	Brussels, Belgium	https://www.eusew.eu/
12-15 July	ISHVAC 2019 - 11th International Symposium of Heating, Ventilation and Air-Conditioning	Harbin, China	
24-30 August	ICR 2019 - 25th IIR International Congress of Refrigeration	Montreal, Canada	https://icr2019.org/
2-4 September	Building Simulation Conference 2019	Rome, Italy	www.buildingsimulation2019.org
5-7 September	IAQVEC 2019	Bari, Italy	www.iaqvec2019.org
26-28 September	Annual Meeting of VDI-Society for Civil Engineering and Building Services	Dresden, Germany	
15-16 October	AIVC 2019 Conference - From energy crisis to sustainable indoor climate	Ghent, Belgium	https://www.aivc2019conference.org/

Upcoming events

futurebuild

05-07 March 2019 / ExCeL, London



REHVA is attending Futurebuild: join us in London

The future of
Energy

REHVA is attending **Futurebuild (ExCeL, London, 5-7 March 2019)**: the exhibition, issued from the former Ecobuild Conference brand, is focused on showcasing the latest innovations, products and materials and sharing unrivalled insights to help building services professionals to tackle the biggest challenges facing the built environment industry.

You will find REHVA at the Knowledge Forum, a dedicated central forum that will bring together academia, universities, key professional bodies, partners and associations, across all built environment industries,

with a common purpose of sharing knowledge. The Knowledge Forum is also the perfect venue to showcase the results of REHVA's European R&I projects: the QUANTUM Project workshop "**Quality management for building performance - Lighthouse examples and tools from the QUANTUM methodology**" will be held there on Tuesday, 5th March, from 15.00 to 16.10.

We are looking forward to meeting you at our booth, stand **D133** at the **Knowledge Forum**, from 5 to 7 March.



@FuturebuildNow



/FuturebuildNow



/FuturebuildNow



/FuturebuildNow



FuturebuildNow

**FOR BETTER HEALTH,
INDOOR AIR QUALITY
AND ENERGY PERFORMANCE
IN ALL BUILDINGS AND COMMUNITIES**

REHVA



Federation of
European Heating,
Ventilation and
Air Conditioning
Associations

VISIT US

futurebuild

05-07 March 2019 / ExCeL, London

**STAND D133 at
Knowledge Forum**



SEMINAR



Friday, 28 February 2019, 15:00-17:30 IST
International Lounge, Hall 1, BEC, Mumbai

High performance educational buildings
and their Indoor Environmental Quality

REHVA-ISHRAE Seminar on “High Performance Educational Buildings and their Indoor Environmental Quality” at ACREX 2019

REHVA-ISHRAE seminar on the “*High Performance Educational Buildings and their Indoor Environmental Quality*” will be held during the ACREX 2019, on Friday 28 of February 2019, from 15:00 to 17:30h in Mumbai, India.

REHVA speakers at the sessions will be **Atze Boerstra**, REHVA Vice-President, **Livio Mazzarella**, REHVA Technology and Research Committee Co-Chair and **Maija Virta**, CEO at Santrupty Engineers, REHVA fellow and ISHRAE member. Mr. Boerstra will discuss on Indoor Air Quality, Mr. Mazzarella will present the visual and acoustic comfort requirements and Mrs. Maija Virta will have a session on Measuring IAQ in educational buildings: old school handled approach vs continuous measurements with sensor networks.

Due to the REHVA knowledge platform cooperation with international partners, REHVA and ISHRAE are also launching a common guidebook on Building Commissioning Guidelines which is planned to be published in May 2019.



Photo by Darshan Gajara on Unsplash



SEMINAR



Friday, 28 February 2019, 15:00-17:30 IST

International Lounge, Hall 1, BEC, Mumbai

High Performance Educational Buildings and their Indoor Environmental Quality

ACREX 2018 was the occasion to launch the REHVA-ISHRAE statement on Indoor Environmental Quality and Energy Performance of Schools. This statement is the manifesto of the REHVA-ISHRAE Task Force on the topic, ongoing since 2017 to develop a comprehensive guidebook that describes how to design a school building with high Indoor Environmental Quality (IEQ) and energy performance levels, promoting increased learning performance by enhancing climatization, ventilation and lighting systems.

ACREX 2019 REHVA-ISHRAE Seminar “High performance educational buildings and their Indoor Environmental Quality” elaborates further on the topic, widening the focus from schools to educational buildings, therefore considering not only primary schools, but also high schools, university buildings, research institutes, etc. In these buildings is it possible to explore the role of IEQ both on students and workers’ activities (i.e. on both learning performances and productivity) and the applicable technologies to simultaneously ensure occupants’ wellbeing and low energy use. Educational buildings are excellent representatives of the broader category of tertiary buildings, for which the theme of comfort is gaining more and more relevance. The seminar will shed light on all the aspects influencing IEQ, from Indoor Air Quality to visual and acoustic comfort, presenting both design principles and applicative examples from the design and operational perspective.

AGENDA

14:30 *Registration*

15:00 **Welcome and introduction**

Chandrasekaran SUBRAMANIAM, ISHRAE President

15:10 **Proposal for universal Indoor Environmental Quality Requirements for classrooms**

Dr. Atze BOERSTRA, REHVA Vice-President (TBC)

15:35 **Indian IEQ standards - presenting ISHRAE Research Project findings (TBC)**

Prof. Dr. Jyotirmay MATHUR and Dr. Shiv NAGENDRA, ISHRAE members

16:00 **Visual and acoustic comfort requirements (TBC)**

Prof. Dr. Livio MAZZARELLA, REHVA Technology and Research Committee Co-Chair

16:25 **Retrofit for Thermal Comfort and Energy Efficiency - Case study of a College Building in Mumbai**

Dr. Roshni UDYAVAR, ISHRAE member

16:50 **Measuring IAQ in educational buildings: old school handled approach vs continuous measurement with sensor networks (TBC)**

Maija VIRTÁ, REHVA fellow and ISHRAE member

17:15 **Questions & Answers and Closing Remarks**

Frank Hovorka, REHVA President-elect



SEMINAR



Friday, 28 February 2019, 15:00-17:30 IST
International Lounge, Hall 1, BEC, Mumbai

High performance educational buildings and their Indoor Environmental Quality

SPEAKERS

15:00-16:00

Dr. Atze BOERSTRA



Founder and Managing Director of BBA Indoor Environmental Consultancy, a Dutch consultancy company specialized in indoor air quality, thermal comfort and healthy buildings. He has a background in Mechanical Engineering and had a PhD degree in building science from the Eindhoven University of Technology. Atze has over 20 years of experience with the investigation of 'sick' buildings and has been involved in the design of >100 above average comfortable & healthy buildings. He is REHVA fellow, honorary member of the Dutch chapter of ISIAQ (International Society of Indoor Air Quality and Climate) and REHVA Vice-president.

Dr. Jyotirmay MATHUR



Dr.-Ing. Jyotirmay Mathur is Professor in Mechanical Engineering at Malaviya National Institute of Technology, Jaipur (India). Dr. Mathur has published 70 research papers in referred international journals and has presented more than 150 papers/talks international seminars / conference, authored 6 books and supervised 20 doctoral candidates. He works in the field of energy planning and modeling, energy conservation in buildings, renewable energy system optimization, codes and standards related to building energy efficiency, Indoor Environment Quality, and HVAC equipment. Dr. Mathur has been part of many National and international committees, and has been part of several International research projects. Currently he is also the Dean of Research and Consultancy at MNIT Jaipur.

Dr. Shiva NAGENDRA



Dr. Shiva Nagendra, SM is presently working as Professor in Department of Civil Engineering, Indian Institute of Technology Madras, Chennai India. He has more than 19 years' research experience in the field of air quality monitoring, modelling, management, control and policy implications. He has published more than 50 research publications in refereed journals, one reference book, and 100 papers in conferences.

Upcoming events



SEMINAR



Friday, 28 February 2019, 15:00-17:30 IST
International Lounge, Hall 1, BEC, Mumbai

High performance educational buildings and their Indoor Environmental Quality

SPEAKERS

16:30 - 17:30

Dr. Livio MAZZARELLA



Full Professor of Building Physics and Building Energy System at Politecnico di Milano, he is a Mechanical Engineer with a Ph.D. in Energetics. He is currently teaching Buildings Physics, Acoustics in Building at the School of Architecture Urban Planning Construction Engineering and Energy Savings and Renewable Energies in Buildings and Applied Acoustics and Lighting at the School of Industrial and Information Engineering.

He is currently president of SC5-CTI, Technical Committee of National Standard Organization on HVAC, Vice president of AICARR, board member of IBPSA-Italy, co-chair of REHVA Technology and Research Committee and president of the REHVA Cooperation Group.

Dr. Roshni UDYAVAR YEHUDA



Dr. Udyavar Yehuda is Vice President of Sustainability ICMQ Certification India Pvt. Ltd. since 2017. She has a master's degree in Architecture from the Academy of Architecture, Mumbai, and a Ph.D. on "Structural Configuration and Thermal Behaviour of Buildings" from SNDT University, Mumbai (2018). From 2003 to 2017 she served as Head of the Rachana Sansad's Institute of Environmental Architecture (RSIEA), Mumbai. She is Principal Investigator in the DST (Department of Science and Technology, Govt. of India) project on "Developing Energy Efficient and ECBC complaint opaque wall assembly for warm-humid and hot-dry climate in India" being conducted under the Science and Technology Park, where she is Advisor on Environment & Sustainability. From 1997-2003 she was involved in environmental research, pedagogy and implementation at the International Institute for Sustainable Future, a United Nations NGO DPI affiliated organization based in Mumbai and New York.

Maija VIRTÄ



Founder and Director of Santruhti engineers Private Limited. She has 25 years of experience in construction and HVAC-industry. Her chief areas of expertise are indoor environmental quality, energy efficiency of buildings as well as sustainable building policies and technologies. During her career she has been involved in developing many technologies for sustainable buildings as well as user-centric IEQ measurement, verification and post-occupancy evaluation processes. She has over 5 years of experience of onsite work to improve IAQ both in Europe and in India. Before moving to India, Maija was CEO of the Green Building Council Finland.

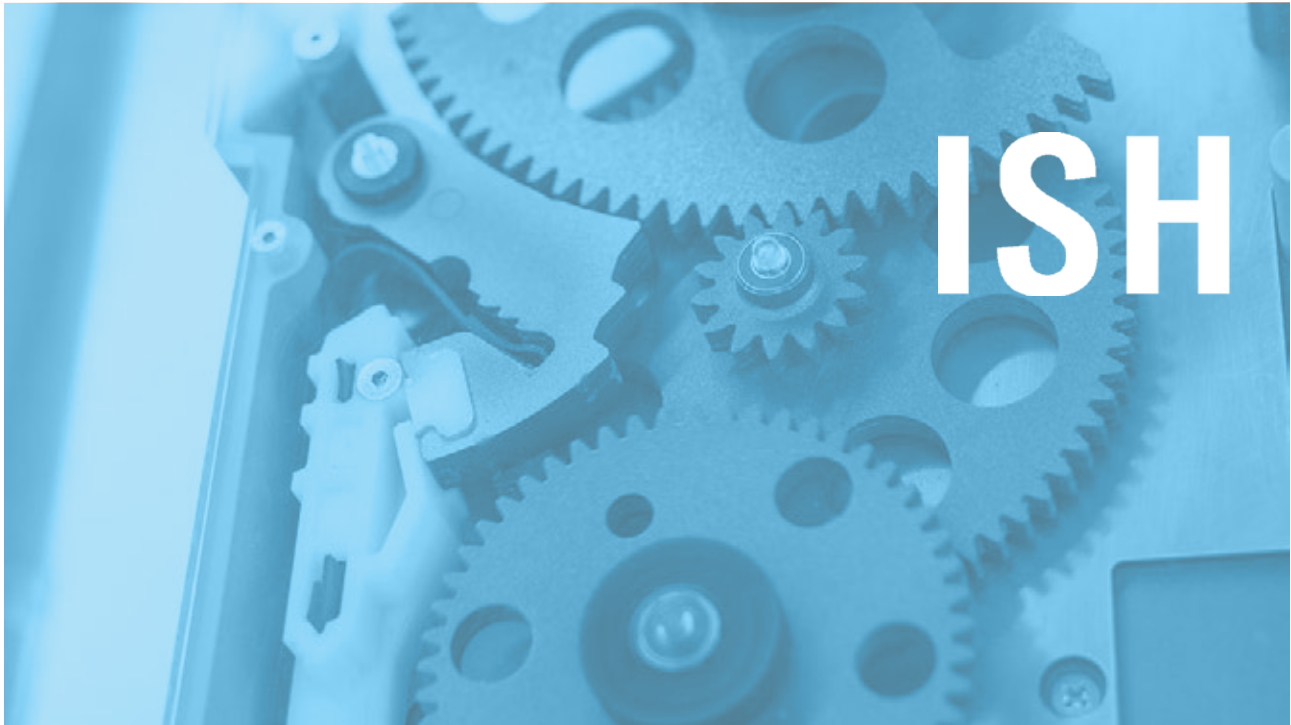

ISH 2019: the world's leading trade fair focusing on the responsible management of water and energy in buildings

ISH sets trends for sustainable heating and air-conditioning technology as well as intelligent home systems. ISH meets the growing demand for comfort, convenience, individualisation, well-being and aesthetics. Integrated solutions are able to cover all these requirements and make a decisive contribution to energy efficient and resource-friendly building systems.

Over 2,400 exhibitors, including all market leaders from home and abroad, launch their latest products, technologies and solutions onto the world market at ISH. ISH has, therefore, a leading role worldwide as the occasion per se when the sector comes together – 64 percent of the exhibitors and 40 percent of the around 200,000 visitors come from outside Germany.

From 2019 ISH is changing its sequence of days. In future, the event will begin on Monday. Next ISH will be held from **11 to 15 March 2019 (Monday to Friday)**.

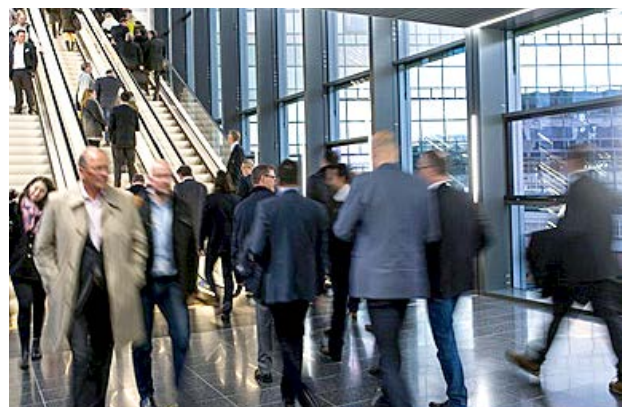

ISH

Frankfurt
11 - 15.03.2019



Upcoming events

ISH Energy: major platform for the groundbreaking building services technologies of tomorrow

The efficient use of energy is one of the most important topics of our times. ISH will be presenting the latest technologies and solutions for the challenges that arise from the need to protect both the climate and our natural resources. The **ISH Energy section of the show is the leading industrial exhibition for efficient heating and air-conditioning technology, combined with renewable energies**, and is thus the major platform for the groundbreaking building services technologies of tomorrow.

As the major vehicle for stimulus in the sector, ISH showcases the future developments in the **heating market**. In Halls 11 and 12, exhibitors will be showcasing their state-of-the-art modern heating technology and heating systems, from efficient heat generation to heat circulation and transfer. The ‘Pumps’ product group, together with other components of the central heating system – expansion vessels, stop-cocks, fittings and heating units - are all grouped together under the heading of ‘Heat Distribution’, in Halls 9.0 and 9.1.



The area covering **cooling and refrigeration, air-conditioning and ventilation technology** is showcased all together in the one place, in Hall 8. The focus, here, is on future-proof solutions for greater automation and convenience – with, at the same time, improvements in energy efficiency and increased use of renewable energies.



Intelligent building services technology is the key to improving energy efficiency, whilst at the same time increasing the degree of convenience and comfort. Home and building automation, energy management, together with monitoring, control and regulation technology, as well as testing equipment, are all located in Halls 10.2 and 10.3. This means that they are right at the heart of the ISH Energy section, since this is the segment that links all the technical trades.



REHVA at ISH 2019: come join our events and secure your free entrance ticket

REHVA will be present at ISH 2019 on Thursday, 14 March 2019, at hall 10.3– System Room, Building Automation and Energy Management for a “REHVA-day” rich of events: in the framework of the “Skills@ISH” events programme, REHVA invites you to attend its QUANTUM Project Workshop, a REHVA Seminar and a networking reHVAClub cocktail reception. Secure your free one-day ticket to come join us at ISH: contact Giulia Marenghi, Project Communication Officer (gm@rehva.eu), to obtain your free entrance voucher. ■



ISH World's leading trade fair
HVAC + Water
Frankfurt am Main, 11. – 15. 3. 2019

REHVA 13th HVAC World Congress
26 - 29 May, Bucharest, Romania

REHVA 13th HVAC WORLD CONGRESS

Built Environment Facing Climate Change



The 13th REHVA Congress, CLIMA 2019, held from 26th till 29th of May in Romania, will address, under the heading "Built environment facing climate change", four main topics - all related to the built environment, the biggest energy consumer of a given national or regional economy:

- I. Modern HVAC&R&S Technology and Indoor Environmental Quality
- II. High Energy Performance and Sustainable Buildings
- III. Information and Communication Technologies (ICT) for the Intelligent Building Management
- IV. Sustainable Urbanization and Energy System Integration

Modern HVAC&R&S Technology and Indoor Environmental Quality

Over 90% of the typical human life is spent indoors. Many of us have adapted to the indoor realm as our "natural" environment IEQ encompasses indoor air quality (IAQ), which focuses on airborne contaminants, as well as other health, safety, and comfort issues such as aesthetics, potable water surveillance, ergonomics, acoustics, lighting, and electromagnetic frequency levels. All these IEQ parameters could not be optimized without advanced HVAC&R&S technologies. The buildings could not be refurbished without advanced HVAC&R&S technologies.

CLIMA 2019 proposed sub-themes are: *Criteria for thermal environment and ventilation; HVAC in residential buildings and schools; Demand controlled, hybrid and passive HVAC systems, Filtration, air cleaning and air distribution; Solar thermal and PV systems; Heat pumps and refrigeration; Natural and mechanical smoke extraction systems; Water and wastewater systems and components etc.*

High Energy Performance and Sustainable Buildings

Buildings shall be constructed and renovated with an appreciation of the importance of providing high-quality and sustainable interior environments, with minimum costs for all users.

CLIMA 2019 sub-topics as: *Low and zero energy building case studies; Predicted and real energy performance of buildings; Energy performance requirements, compliance assessment and cost optimality; Simulation models and predictive tools for the buildings HVAC, IEQ and energy; Building components and double skin facades; Occupant behaviour and energy demands in buildings; Future and Emerging Technologies (FET): Nano-, micro- and bio-technologies for buildings components and HVAC systems; Mandatory and voluntary certification and labelling schemes for new and existing buildings; Renovation of historic buildings;* could attract an important number of researchers, industrials and young students.

Upcoming events

Information and Communication Technologies (ICT) for the Intelligent Building Management

CLIMA 2019 addresses topics like: *New ICT-based solutions for systems and building automation; Energy Efficiency through behavioural adaptation based on ICT solutions; Indoor Environment control with advanced BMS solutions; Sensors and methods to control and authenticate indoor environment; Advanced fault detection and diagnostics; Integrated BIM solutions for buildings and systems; Digitalization of buildings equipment etc.*

Sustainable Urbanization and Energy System Integration

With justified interest in this area CLIMA 2019 will contribute by offering opportunity to researchers and experts in this field to present their work on subtopics like: *Grid interaction of nZE, green and passive buildings; Architectural design integration; Health, demographic change and wellbeing; Energy management and distributed energy systems (heat and power generation, district heating and cooling); Innovative heating and cooling solutions using geothermal energy; Large scale and seasonal thermal storage; Smartness indicators; Demonstrating innovative nature-based solutions in cities etc.*

The venue of CLIMA 2019 will be its capital Bucharest which is the 6th European town in population terms and the largest city of Romania. It is a beautiful and very alive Romanian cultural, industrial and financial centre, offering historical or modern conference venues, very cosy hotels, appealing restaurants, robust infrastructure and a lot of quite unique places like traditional museums, recreational green areas and genuine “shopping arcades”.

Some expected figures of CLIMA 2019 congress are the following:

- more than 100 CLIMA 2019 ambassadors and 50 partners promoting this event worldwide;
- more than 1000 attendees (researchers, engineers, architects, students etc.);
- more than 750 papers (with a special care for the selection of those to be published in like Scopus or Web of Science indexed journals).
- more than 20 technical and scientific workshops.

You can find more details on our website www.clima2019.org or ask for more information at our e-desk found on info@clima2019.org.

Seeking for partnership

Here are only few reasons for getting a cooperation agreement with CLIMA 2019 organisers:

- **The congress provides a targeted audience** (event provides you access to an invested, enthusiastic audience of more than 1000 attendees and probably more than 10000 visitors of the exhibitions of posters and products which will have free access).
- **Potential for data capture is immense** if you are present at CLIMA 2019 where your target audience is present; you will create an immense potential for data/lead capture. A creatively designed engagement tactic, possibly integrated with social media, mobile apps, or experiential technologies like RFID and geofencing could mean access to target data and analytics help you shape or promote your publication.
- **You will leverage the media coverage** as CLIMA 2019 will receive the most vast promotion on social media, digital media, press circles and traditional media, reaching the most broader audience since its appearance in 1975.
- **Build credibility and get brand recognition** by choosing CLIMA 2019, which allows you to associate your brand with other reputed brands in the market; you can elevate your brand perception and image enormously, taking advantage of a great way to emerge or acknowledge as a credible business in our target audience’s minds; your logo will be seen on the event site and on selected promotionals.
- **Get a chance to know other media providers or future clients** because networking is probably one of the best aspects of our congress; as one of the CLIMA 2019 partners, you’ll get to meet decision makers or fellow editors and companies that you can do business with in the future.
- **Give back to the scientific community** getting to establish goodwill and showing the community that you’re a reliable promoter that’s able and willing to support all things local; think of partnership as a way of giving back to the technical and scientific community and thanking them for their support. ■





REHVA 13th HVAC World Congress
26 - 29 May, Bucharest, Romania

The first set of CLIMA 2019 Workshops announced!

CLIMA 2019 continues with the longstanding tradition to offer several practical, interactive workshops beside the plenary paper sessions. The workshops are organised by REHVA and its international sister associations, European research and innovation projects, as well as REHVA supporter companies representing leading HVAC manufactures and service providers. We are happy to announce the first set of interesting workshops awaiting our CLIMA 2019 participants.



SHASE

Title: NZEB concepts in Europe and Japan

Organisers: REHVA & SHASE

Chairs: Jarek Kurnitski, REHVA; Gyuyoung Yoon, SHASE

Speakers: Jarek Kurnitski, REHVA and Gyuyoung Yoon, SHASE (Chairs); Hideharu Niwa, SHASE

Short description: Recent developments of nearly zero and zero energy requirements in EU and Japan are discussed and possibilities to benchmark NZEB performance levels in different climates and countries will be analysed in more general. The aim is to show how energy performance requirements are set and how these can be compared so that climatic differences, national input data and calculation rules are taken into account.



INTERNATIONAL SOCIETY OF
INDOOR AIR QUALITY
AND CLIMATE

Title: Evidence-based ventilation needs and development process of future standards

Organiser: REHVA & ISIAQ

Chairs: Jarek Kurnitski, REHVA; Pawel Wargocki, ISIAQ

Speakers: Jarek Kurnitski, REHVA and Pawel Wargocki, ISIAQ; Bjarne Olesen, William Bahnfleth

Short description: Recent research findings, their interpretation and meaning for ventilation system sizing is discussed with the aim to establish evidence-based design criteria of ventilation rates for residential and non-residential buildings. The workshop attempts to summarize existing evidence, possible knowledge gaps and to specify further actions what are needed to implement evidence-based ventilation rate values into future indoor climate standards such as EN 16798-1:2019 and possibly some other ventilation standards.

Upcoming events



Title: Dissemination and roll-out of the set of EPB standards. Asking feedback from practitioners

Organiser: REHVA & EPB Center

Chairs: Jaap Hogeling, Dick van Dijk

Short description: The EPB Center (www.epb.center) has been set up to support the uptake of the (CEN and CEN ISO) Energy Performance of Buildings standards developed under EC Mandate M/480, by providing tailored information, technical assistance and capacity building services for involved stakeholders. The purpose of this workshop is to inform the participants about the ongoing activities, more importantly to interact and obtain feedback from professionals involved or interested in the EPB assessment and in the implementation of the related articles of the recently revised EPBD.



Title: From regular inspection to BACS supported HVAC system technical monitoring, commissioning and certification

Organiser: REHVA & eu.bac

Chairs: Atze Boerstra, REHVA; Peter Hug, eu.bac

Speakers: DG ENERGY (tbc); Bonnie Brooks - Siemens/eu.bac; Stefan Plesser, synavision; Cormac Ryan, CoPilot

Short description: This workshop will present the wide spectrum of tools supported by BACS to improve and optimize HVAC systems' performance and make it transparent to building owners and operators. Speakers will present requirements of the revised EPBD, discuss the role of BACS in ongoing commissioning with outlook to the future, present BACS supported technical monitoring tools and introduce the COPILOT commissioning certification scheme developed with contribution of REHVA Member Associations and other partners.



Title: Towards optimized performance, design, and comfort in hybridGEOTABS buildings

Organiser: hybridGEOTABS

Chair: Lieve Helsen, KULeuven

Speakers: Lieve Helsen, KULeuven; Eline Himpe, UGent; Ongun Berk Kazanci, DTU; Qian Wang, Uptonor/KTH; Wim Boydens, Boydens Engineering.

Short description: HybridGEOTABS refers to the integration of GEOTABS (Geothermal heat pumps in combination with Thermally Activated Building Systems) with secondary heating and cooling systems. This technology offers huge potential to meet heating and cooling needs throughout Europe in a sustainable way, while providing a very comfortable conditioning of the indoor space. This workshop will discuss the effects of radiant heating and cooling systems on IEQ, as well as the proper design of hybridGEOTABS buildings.



Title: Building commissioning in Europe

Organiser: QUANTUM

Chairs: Stefan Plesser, Ole Teisen

Speakers: Stefan Plesser, IGS TU Braunschweig; Jan Mehnert, IGS; Ole Teisen, Sweco; Margot Grim, E7; Cormac Ryan, CoPilot

Short description: New buildings and deep retrofits with their sophisticated systems for heating, cooling and air conditioning are rather complicated technical systems. Especially, building automation and control systems have added complexity to building projects. As a consequence, the performance gap appeared. Quality management, a process of supporting the fulfilment of requirements, can solve this problem. The workshop will present the current stage of quality management for building performance. This workshop is part of the project 'QUANTUM - Quality management for building performance' and has received funding from the European Union's Horizon 2020 research and innovation programme under grant agreement No. 680529.



Title: Why people matter? Exploitation strategies for people-centred design

Organiser: TripleA-reno & MOBISTYLE projects

Chair: Dr. Simona D'Oca, Huygen Engineers & Consultants

Speakers: Dr. Simona D'Oca, Huygen Engineers & Consultants; Dr. Dan Podjed, Institute for Innovation and Development of the University of Ljubljana; Ana Tisov, Huygen Engineers & Consultants

Short description: the workshop is organised by the H2020 projects TripleA-reno and MOBISTYLE, which both adopted a people-centred approach to improve the performance of the European building stock reaching beyond the focus on technology-driven solutions. The workshop will introduce the TripleA-reno and MOBISTYLE open ICT solutions, followed by a dynamic interactive brainstorm session around the following questions: What problems can the gamified platforms and ICT solutions solve for the engineering branch? Why these open platforms are better than the existing ones? What results do these projects offer for engineers and manufacturers? Who are the users of these innovative solutions and how can we better deliver the tools to them?



Title: The Power of the Cloud

Organiser: Belimo Automation AG

Chair: Dr. Marc Thuillard

Speakers: Dr. Marc Thuillard, Dipl. Ing. Marc Steiner, Dipl. Ing. Forest Reider

Short description: This workshop presents how the power of the cloud can benefit the HVAC industry, by facilitating the exchange of information between stakeholders, it can affect the entire lifecycle of a building. The design, commissioning, operation and maintenance can leverage the cloud as a medium to store and share information, configure and monitor devices, and provide a gateway to integrate technologies. It provides a medium for transparency, intelligent monitoring, and optimization.



Title: The Value of Good Performance - How High-Performance Buildings Protect the Asset value and Increase your Bottom Line

Organiser: BRE- Building Research Establishment (BRE) UK Ltd.

Sponsor: BRE Global

Speakers: Dr. Andy Lewry and James Fisher, presenters of case studies (TBC)

Short description: The discussion would address questions such as: we have the ability to design good buildings and the knowledge to operate them in an effective and efficient manner - so why doesn't it happen? Why doesn't the design feed through to performance-in-use? "The performance gap", with increased energy usage of between 200-450%: what are causes and how can this be remedied? What is the effect on the asset and its value from poor performance? The second session will be a showcase for high performance buildings in Romania - Where 4 cases were presented and then the discussion on how the sustainable performance and certification was achieved.



Title: Costs and benefits of antibacterial filter and its effects on energy saving, human health and worker productivity

Organiser: Rhoss S.p.A

Sponsor: Rhoss S.p.A

Speakers: Leonardo Prendin - Marketing Director, Micaela Ranieri - Product Manager

Short description: The discussion would present *the results of a literature review aimed at exploring how to integrate the health and performance effects on building occupants into the economic benefits of the antibacterial filter. In detail, the research focuses on the methods used to evaluate costs and benefits produced by the application of a biocidal filter, comparing it with a traditional one, by means of computing both direct costs (related to hospitalization and antibiotic treatment) and indirect costs (mainly identified with the loss of working days). Therefore, this workshop will try to enhance the focus on energy technology developing an analysis of the impact on human health and employee performance.*

Upcoming events



Title: Third-party confidence for building projects: Eurovent tools to deliver value

Organiser: EUROVENT CERTITA CERTIFICATION, PRODBIM, COPILOT

Sponsor: EUROVENT CERTITA CERTIFICATION

Speakers: Erick Melquiond - President of Eurovent Certita Certification; Thibaud De Loynes -Project Director of Prodbim; Cormac Ryan -Project Director of Copilot

Short description: As quality is critical to risk management, Eurovent Certita Certification have developed a portfolio of solutions to help you derisk your products and projects. Third party certification provides the best assurance that “you get what it says on the box”. This reassurance adds value as it de-risks products and projects. Eurovent offers third party certification of HVAC products and projects. They cover the entire lifecycle of HVAC from manufacture to installed operation.

The workshop will introduce you to:

1. ECP certification programme: focus on Indoor Air Quality
2. HVAC Products data from PIM to BIM: PRODBIM
3. The installation and operation of HVAC equipment: COPILOT Building Commissioning Solutions

Title: Energy renovation of building stock towards nZEB levels: How to prepare the market for the challenge?



Organiser: Fit-to-nZEB and iBRoad projects, Grundfos Pompe Romania

Sponsor: Fit-to-nZEB and iBRoad projects, Grundfos Pompe Romania

Speakers: Horia Petran, INCD URBAN-INCERC & Cluster Pro-nZEB
Dragomir Tzanev (Eneffect), Octavian Serban (Grundfos Pompe Romania)

Short description: *The workshop is organised by the H2020 projects iBRoad (Individual Building Renovation Roadmaps) and Fit-to-nZEB (...) together with Grundfos Romania representing the BetterHome initiative. The workshop focuses on developing and combining effective tools to facilitate deep energy renovation of existing building stock at high performance levels in order to support the achievement of decarbonising targets for 2050.*

CLIMA 2019 - Important dates and deadlines

REHVA Annual Meeting	May 24-26 2019
REHVA World Congress CLIMA 2019 & Exhibition	May 26-29 2019
Additional social programme	May 29-31 2019

You can find more details on the event website www.clima2019.org

or ask for more information at our e-desk: info@clima2019.org.

Leaders in Building Services

– Network of 27 European HVAC Associations joining 120 000 professionals

REHVA SUPPORTERS

REHVA MEMBERS





No.01: DISPLACEMENT VENTILATION IN NON-INDUSTRIAL PREMISES

Håkon Skistad (ed.)
 Elisabeth Mundt, Peter V. Nielsen, Kim Hagström, Jorma Railio



No.02: VENTILATION EFFECTIVENESS

Elisabeth Mundt (ed.)
 Hans Martin Mathisen, Peter V. Nielsen, Alfred Moser



No.03: ELECTROSTATIC PRECIPITATORS FOR INDUSTRIAL APPLICATIONS

Kjell Parle (ed.)
 Steve L. Francis, Keith M. Bradburn



No.04: VENTILATION AND SMOKING

Håkon Skistad, Ben Bronsema (eds.)



No.05: CHILLED BEAM APPLICATION GUIDEBOOK

Majja Virta (ed.)
 David Butler, Jonas Grönlund, Jaap Hogeling, Erik Lund Kristiansen, Mika Reinikainen, Gunnar Svensson



No.06: INDOOR CLIMATE AND PRODUCTIVITY IN OFFICES

Pawel Wargocki, Olli Seppänen (eds.)
 Johnny Andersson, Atze Boerstra, Derek Clements-Croome, Klaus Fitzner, Sten Olaf Hanssen



No.07: LOW TEMPERATURE HEATING AND HIGH TEMPERATURE COOLING

Jan Babiak, Bjarne W. Olesen, Dušan Petráš



No.08: CLEANLINESS OF VENTILATION SYSTEM

Pertti Pasanen (ed.)
 Birgit Müller, Rauno Holopainen, Jorma Railio, Harry Ripatti, Olle Berglund, Kimmo Haapalainen



No.09: HYGIENE REQUIREMENT FOR VENTILATION AND AIR CONDITIONING

Based on VDI 6022



No.10: COMPUTATIONAL FLUID DYNAMICS IN VENTILATION DESIGN

Peter V. Nielsen (ed.)
 Francis Allard, Hazim B. Awbi, Lars Davidson, Alois Schälin



No.11: AIR FILTRATION IN HVAC SYSTEMS

Jan Gustavsson (ed.)
 Alain Ginestet, Paolo Tranville, Marko Hyttinen



No.12: SOLAR SHADING

Wouter Beck (ed.)
 Dick Dolmans, Gonzague Dutoo, Anders Hall, Olli Seppänen



No.13: INDOOR ENVIRONMENT AND ENERGY EFFICIENCY IN SCHOOLS - PART 1 PRINCIPLES

Francesca R. d'Ambrosio Alfano (ed.)
 Laura Bellia, Atze Boerstra, Froukje van Dijken, Elvira Ianniello, Gino Lopardo, Francesco Minichiello, Piercarlo Romagnoni, Manuel C. Gameiro da Silva



No.14: INDOOR CLIMATE QUALITY ASSESSMENT

Stefano P. Corgnati, Manuel C. Gameiro da Silva (eds.)



No.15: ENERGY EFFICIENT HEATING AND VENTILATION OF LARGE HALLS

Karel Kabele (ed.)
 Ondřej Hojer, Miroslav Kotrbatý, Klaus Sommer, Dušan Petráš



No.16: HVAC IN SUSTAINABLE OFFICE BUILDINGS

Majja Virta (ed.)
 Frank Hovorka, Andrei Litiu, Jarek Kurnitski



No.17: DESIGN OF ENERGY EFFICIENT VENTILATION AND AIR-CONDITIONING SYSTEMS

Nejc Brelih (ed.)
 Olli Seppänen, Thore Bertilsson, Mari-Liï Maripuu, Hervé Lamy, Alex Vanden Borre



No.18: LEGIONELLOSIS PREVENTION IN BUILDING WATER AND HVAC SYSTEMS

Sergio La Mura, Cesare M. Joppolo, Luca A. Piterà (eds.)
 Jean Pierre Angermann, Mark Izard



No.19: MIXING VENTILATION

Dirk Müller (ed.)
 Claudia Kandzia, Risto Kosonen, Arsen K. Melikov, Peter V. Nielsen



No.20: ADVANCED SYSTEM DESIGN AND OPERATION OF GEOTABS BUILDINGS

Franziska Bockelmann, Stefan Plesser, Hanna Soldaty



No.21: ACTIVE AND PASSIVE BEAM APPLICATION DESIGN GUIDE

REHVA-ASHRAE joint publication



No.22: INTRODUCTION TO BUILDING AUTOMATION, CONTROLS AND TECHNICAL BUILDING MANAGEMENT

Andrei Litiu (ed.)
 Bonnie Brook, Stefano P. Corgnati, Simona D'Oca, Valentina Fabi, Markus Keel, Hans Kranz, Jarek Kurnitski, Peter Schoenenberger, Roland Ullman



No.23: DISPLACEMENT VENTILATION

Risto Kosonen (ed.)
 Arsen K. Melikov, Elisabeth Mundt, Panu Mustakallio, Peter V. Nielsen



No.24: FIRE SAFETY IN BUILDINGS

Othmar Brändli, Rainer Will (eds.)
 Thomas Winkler, Bernd Konrath, Jörg Reintsema, Frank Lucka, Paul White, Grzegorz Sypek, Valery V. Kholshchevnikov, Dmitry Samoshin

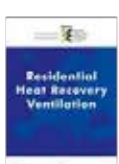

No.25: RESIDENTIAL HEAT RECOVERY VENTILATION

Jarek Kurnitski (ed.)
 Martin Thalfeldt, Harry van Weele, Macit Toksoy, Thomas Carlsson, Petra V. Bednarova, Olli Seppänen

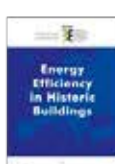

No.26: ENERGY EFFICIENCY IN HISTORIC BUILDINGS

Francesca R. d'Ambrosio Alfano, Livio Mazzarella (eds.)