

The REHVA European HVAC Journal

Volume: 51

Issue: 6

November 2014

www.rehva.eu



Innovative HVAC system solutions in high performing buildings

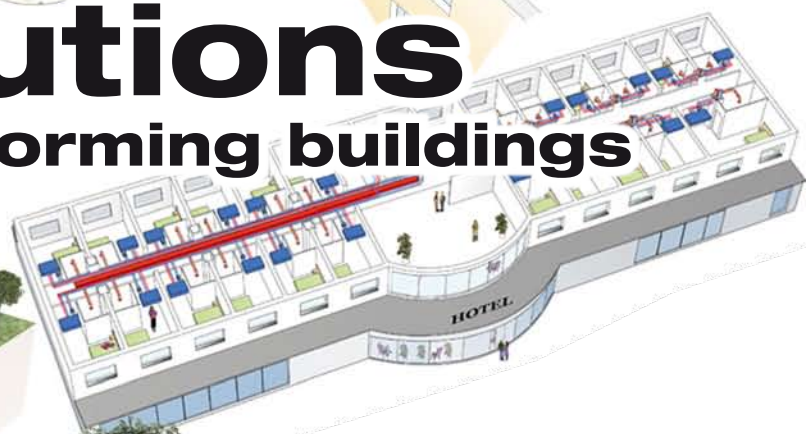
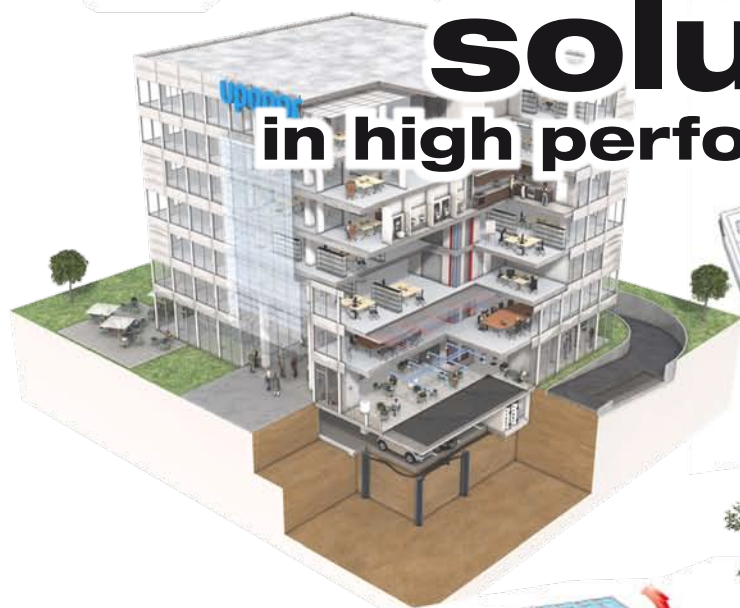

**Visible design
hardly noticed**



Our well-designed comfort modules are draught free, energy efficient and working in silence. Function and form in perfect harmony hardly noticeable. We have created well-balanced indoor climate for over 80 years and are represented in more than 40 countries. Learn more about our range of products at swegon.com



Parasol is a flexible comfort module with cooling, heating and ventilation. Through its 4 way spread it creates optimal indoor climate regardless of the installation placement in the room.

Swegon

Guest Editor: Stefano Corgnati, Italy
stefano.corgnati@polito.it

General Executive: Süleyman Bulak

Editorial Assistant: Cynthia Despradel

REHVA BOARD

President: Karel Kabele

Vice Presidents:

Stefano Corgnati
Ioan Silviu Dobosi
Egils Dzlezitis
Frank Hovorka
Jarek Kurnitski
Manuel Carlos Gameiro da Silva

EDITORIAL BOARD - 2014

Francis Allard, France
Ahmet Arisoy, Turkey
Jan Aufderheijde, the Netherlands
Marianna Brodatch, Russia
Vincenc Butala, Slovenia
Francesca R. d'Ambrosio, Italy
Ioan Silviu Dobosi, Romania
Egils Dzlezitis, Latvia
Andy Ford, UK
Signhild Gehlin, Sweden
Jaap Hogeling, the Netherlands
Karel Kabele, Czech Republic
Jarek Kurnitski, Estonia
Eduardo Maldonado, Portugal
Livio Mazzarella, Italy
Renato Merati, Italy
Birgit Müller, Germany
Natasja Nord, Norway
Bjarne W. Olesen, Denmark
Branimir Pavkovic, Croatia
Dušan Petráš, Slovakia
Olli Seppänen, Finland
Jerzy Sowa, Poland
Jose Tadoro, Spain
Branislav Todorovic, Serbia
Maija Virta, Finland
Peter Wouters, Belgium

ADVERTISEMENTS

Ms Cynthia Despradel
cd@rehva.eu

SUBSCRIPTIONS and CHANGES OF ADDRESSES

REHVA OFFICE:
Washington Street 40
1050 Brussels, Belgium
Tel: 32-2-5141171, Fax: 32-2-5129062
info@rehva.eu, www.rehva.eu

PUBLISHER

TEKNIK SEKTÖR YAYINCILIĞI A.Ş.
Balmumcu, Barbaros Bulvarı Bahar
Sk. Karanfil Apt. No:2/9
Beşiktaş /Istanbul, Turkey

REHVA Journal is distributed in over 50 countries through the Member Associations and other institutions. The views expressed in the Journal are not necessarily those of REHVA or its members. REHVA will not be under any liability whatsoever in respect of contributed articles.

Cover photos: Thermia Heat Pumps

Contents

Download the articles from www.rehva.eu -> REHVA Journal

EDITORIAL

- 5 Towards post-carbon cities**
Stefano Paolo Corgnati

ARTICLES

- 7 System for Zero Energy Houses**
Enrico Fabrizio
- 12 Modular heat pumps: Energy performance**
Michele Albieri, Pio Faldelli, Attilio Masoch & Silvia Morassutti
- 18 Energy performance of radiators with parallel and serial connected panels**
Mikk Maivel, Martin Konzelmann & Jarek Kurnitski
- 22 All-in-one high-performing system for ZEB houses**
Maria Ferrara, Frederic Kuznik & Joseph Virgone
- 28 Certified ClimateHouse building in Mediterranean climate**
Cristina Becchio, Gianni Carlo La Loggia & Lara Orlietti
- 32 Deep energy retrofit of vernacular housing**
Manuela Almeida, André Coelho, Ana Rodrigues, Gonçalo Machado, Inês Cabral & Marco Ferreira
- 38 The challenge of designing and building nZEBs: a single-family house in Italy**
Stefano Paolo Corgnati, Cecilia Guala & Marco Luciano
- 44 Energy efficiency and HVAC systems in existing and historical buildings**
Livio de Santoli & Francesca R. d'Ambrosio Alfano
- 50 Comfort cooling and solar power – a perfect match?**
Elsa Fahlén, Henrik Olsson & Niklas Christensson

INTERVIEW

- 57 Interview of REHVA Board Members on nearly Zero Energy Buildings**

EU POLICY NEWS

- 60: New European Commission – Juncker merges Energy and Climate change portfolios
- 60: 2030 Climate and Energy Package – disappointing Council decision on energy efficiency

NEWS

- 61: REDay2014 – Energy Director General, Dominique Ristori confirms housing as a priority sector
- 62: AQUA-THERM RUSSIA 2015
- 63: ISH 2015 – Comfort meets Technology
- 64: Halton Foundation grants promote better indoor ENVIRONMENT around the world
- 66: Over 600 exhibitors at FinnBuild exhibition in Finland

REHVA WORLD

- 67: REHVA Annual Meeting and Conference 2015

PROJECT NEWS

- 68: Integrated Design: Lessons learned from good practice examples
- 69: Integrated Design: National activities towards widespread use of NZEB

PUBLICATIONS

- 70: VDI-Guidelines published October–November 2014

72 EVENTS

Advertisers

- | | |
|-------------------------------------|-------------------------------------|
| ✓ Swegon Front cover interior | ✓ Eurovent Certification 49 |
| ✓ ISH Frankfurt..... 4 | ✓ RETTIG 56 |
| ✓ Aqua Therm Russia 6 | ✓ Flaktwoods 65 |
| ✓ Belimo..... 11 | ✓ ACREX 2015 71 |
| ✓ Vaisala 31 | ✓ WSED 2014..... 73 |
| ✓ Lindab..... 37 | ✓ REHVA Guidebooks Back cover |
| ✓ Friterm 43 | |

Next issue of REHVA Journal

Instructions for authors are available at www.rehva.eu
(> Publications & Resources > HVAC Journal > Journal information)

Send the manuscripts of articles for the journal to Cynthia Despradel cd@rehva.eu



The world's leading trade fair
The Bathroom Experience, Building, Energy, Air-conditioning Technology
Renewable Energies

Frankfurt am Main, 10 – 14. 3. 2015

Water + Energy Elements of Success.

ISH is the world's leading trade fair focusing on the combined themes of water and energy. Only here will you find future-oriented technologies that offer maximum user comfort and convenience. Visit the leading event for sustainable sanitary solutions and innovative bathroom design as well as energy-efficient heating, air-conditioning, cooling and ventilation technologies in combination with renewable energies.

www.ish.messefrankfurt.com

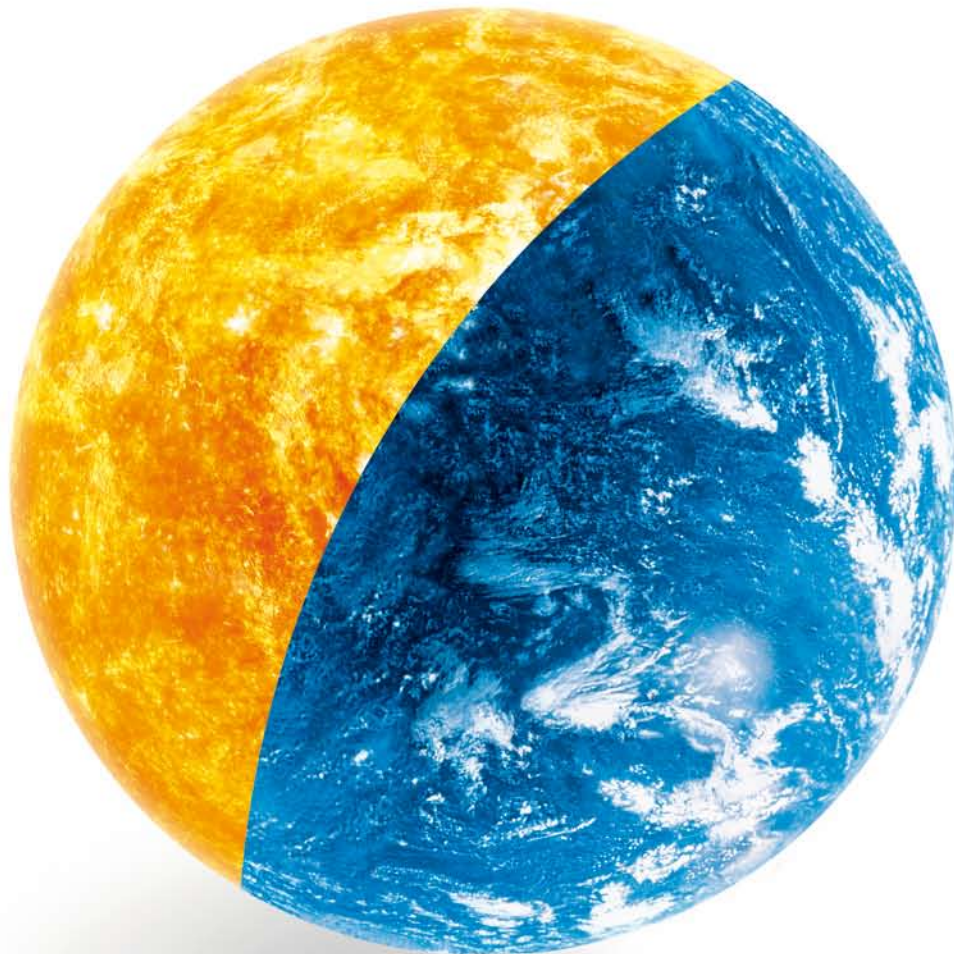

Towards post-carbon cities



STEFANO PAOLO CORGNATI
Vice-president of REHVA,
TEBE Research Group, DENERG,
Politecnico di Torino, Italy,
stefano.corgnati@polito.it

The challenge set by the European Commission with regard to nearly Zero-Energy Buildings should necessarily evoke a wider scenario, not only in terms of time but also in terms of scale of the problem.



North Korea, pollution in Pyongyang, 2005.



China, Shenzhen Building International Low-Carbon City project.

Indeed, nZEBs will be regulated until 2020, but the common perspective is already the creation of a vision towards 2050. Moreover the Commission is increasingly moving the question from the single building level to the building's district and to the city. In practice, the direction to take in order to provide a strong lead in promoting a reduction of the building environmental impact is nowadays the *post-carbon city* one. This future projection of cities carbon free with respect to the building stock should have a decisive effect on the building concept, in terms of building elements, structures, building systems but also, and above all, in terms of sociology, with respect to the interaction modes between end-users and the whole building. Nowadays this challenge is often analyzed only with regard to its energetic and economical aspects. A new kind of analysis, whose drivers become motivational and behavioral, reveals to be necessary in order to win this global challenge. In this visionary process of a path towards the post carbon city it is important to reflect upon the technological and innovative perspectives related to air conditioning, with reference to their current and future applications to buildings.

In this Special Issue our aim is to deal with new HVAC frontiers, by analyzing what currently is realized as innovative experience, but also what can be explored as innovation of the building envelope-system unit. ■

EXPLORE THE WHOLE RUSSIAN HVAC & R MARKET WITH AQUA-THERM

INTERNATIONAL EXHIBITIONS

for domestic and industrial heating, water supply, sanitary, air-conditioning, ventilation, equipment for pools, saunas and spa

aqua THERM

ST. PETERSBURG

18–21 March 2015
EXPOFORUM
www.aquatherm-spb.com



Organized by



aqua THERM

Organized by



MOSCOW

3–6 February 2015
Crocus Expo
www.aquatherm-moscow.ru



aqua THERM

NOVOSIBIRSK

17–20 February 2015
Novosibirsk Expo Centre
www.aquatherm-novosibirsk.ru

Organized by



Developed by  Reed Exhibitions®
Messe Wien

Specialized sections  World of
Water & Spa

Climate Control
Equipment 

Special project  new
energy

System for Zero Energy Houses

Designing Zero Energy Buildings implies not only a good envelope design and passive strategies, but also the use of highly efficient systems for heating, cooling and mechanical ventilation. This paper summarizes the main features of the systems that can be adopted into a ZEB.



ENRICO FABRIZIO
 Assistant professor
 DISAFA
 University of Torino, Grugliasco (TO), Italy
 enrico.fabrizio@unito.it

Keywords: multi-source multi-product systems, integrated systems.

A key role in the design and operation of zero energy buildings is played by the systems. It is well known that in the design process, once that the energy demand of the building has been reduced up to a limit which is a compromise between energy efficiency and financial feasibility, the systems are designed to reach the net zero energy target (in what way it may be seen, e.g. site energy, source energy, emissions, costs, etc.). Due to this reason, latterly there has been a new generation of systems especially designed for highly efficient buildings, Passivhaus and ZEBs able to integrate different energy sources to cover with the maximum efficiency the building energy demand.

There are basically three aspects that characterize a system for a ZEB. The first one is the need of producing on-site at least some of the energy that is consumed. A second aspect, which is characteristic of a ZEB in general, is the production from renewable sources that must supply a great portion of the energy requirement. This implies the use of systems that exploit renewable sources, with thermal or electric storages and able to cope with the variation of the driving forces. The third characteristic is the increase in the energy efficiency by using heat recovery, new technologies and the principle of hybrid system. It is known in fact, that the combination of two or more energy conversion devices and/or

two or more energy sources for the same device, when integrated, overcomes the limitations that may be inherent in either source or device [1].

The energy uses of a ZEB can be summarized into:

- heating energy for high-temperature space heating, at a temperature between 55°C and 80°C;
- heating energy for low-temperature space heating, at a temperature between 35°C and 50°C (radiant heating);
- heating energy for DHW production, at a temperature between 40°C and 65°C;
- cooling energy for space cooling, at a temperature between 7°C and 19°C;
- cooling energy for air dehumidification, at a temperature below 12°C.

	Plug loads, Lighting	Space heating	DHW	Space cooling	Ventilation
Electricity from grid	✓	Air-to-air heat pump (Compact HVAC for Passivhaus)			
Solar					
Natural gas					
Electricity from & to grid	✓	Cogenerator (ICE, Stirling,...)			C/D units
Solar					
Natural gas					
Electricity from grid	✓	Heat pump-condensig boiler			C/D units
Solar					
Natural gas					
Electricity from grid	✓	Reversible heat pump HR			C/D units
Solar					
Natural gas					

Figure 1. Classification of some systems for ZEBs as a function of energy uses (columns) and energy sources (rows).

The aspects that characterize the energy demand of a (nearly) ZEB are the followings:

- the energy demand for space heating is dramatically reduced (values can be around 15 kWh/m²a) in comparison with buildings that are in compliance with the legislative requirements; also the heating load for space heating is low, especially in zero energy homes (single family houses);
- the heating load for the DHW production is greater (double or more) than the space heating load, concentrated in time but constant throughout the year;
- there is the necessity of recovering the ventilation heat losses in order to guarantee the high performances of the whole building design, which implies the adoption of a mechanical ventilation system.

A first consequence of these assumptions is that a system for a (nearly) ZEB should integrate the ventilation and/or the DHW production into the traditional

heating systems. In some cases, also the space cooling is required and provided by a packaged system.

Then, due to the small capacities, maintenance and operation simplifications, integrated solutions are preferred.

In the following paragraphs, a classification of some of the various new types of systems that were recently developed is presented and some of these systems are outlined. A detailed review can be found on [2]. Most of these systems are suitable to single family houses in north and central Europe climates; on the other hand, this is quite understandable since the design ZEBs has started from single family houses.

Integrated systems for mechanical ventilation

These systems provide the mechanical ventilation together with space heating, domestic hot water production and – in some cases – space cooling. One of the first example of such system has been the compact packaged



Figure 2. An example of integrated system for ventilation, DHW production and hydronic space heating.

HVAC system of the Passivhaus design, that is based on a air-to-air heat pump of small capacity integrated with the ventilation heat recovery and supply fan, and the domestic hot water production with a suitable water storage [3].

This system is typical of the first Passivhaus and has the characteristic of using the air loop of the ventilation system to cover the remaining heat load of the spaces, which in some cases may be a limitation. More recently, in fact, systems that are similar in its general concept to the first one but that can provide also a hydronic heating (hot water at moderate temperature for radiant space heating) were manufactured. The heating capacity of the air side is around 2 kW while the heating capacity of the hydronic circuit is around or below 10 kW.

If not integrated with the DHW and space heating, centralized mechanical ventilation units must be used. These can have a supplementary electric heating for air heating, can be equipped with a static or a rotary heat exchanger and, for cooling purposes, can have a water coil installed on the primary air duct. A further configuration of these centralized units is the one equipped with reversible heat pumps working between

the exhaust air and the supply air. Such systems cover not only the ventilation heating load but also, to a certain amount, the space heating load. In mid-season they work in free cooling mode.

Residential CHP

Many new types of small size CHP for residential applications were recently developed, especially by manufacturers of boilers, and a valid alternative to traditional internal combustion engines CHP that are available on medium sizes, are the external combustion Stirling engines. This is because they have small capacities (their typical size is 1 kW of electricity – with an electric efficiency of 15% – 6 kW of heat – with a thermal efficiency of 80% – and a 6–20 kW of additional heating capacity of the gas burner), they run quietly and can be installed close to living spaces, have less emissions and can possibly make use of thermal wastes. As can be seen in **Figure 4**, they appear as standard households' equipment or boilers. However the use of a CHP, even though of a small size, into a ZEB should be always carefully evaluated because the feasibility of such systems strictly depends on the running hours, on the feed-in tariff for the electricity produced and exported outside the ZEB, and on the sizing.

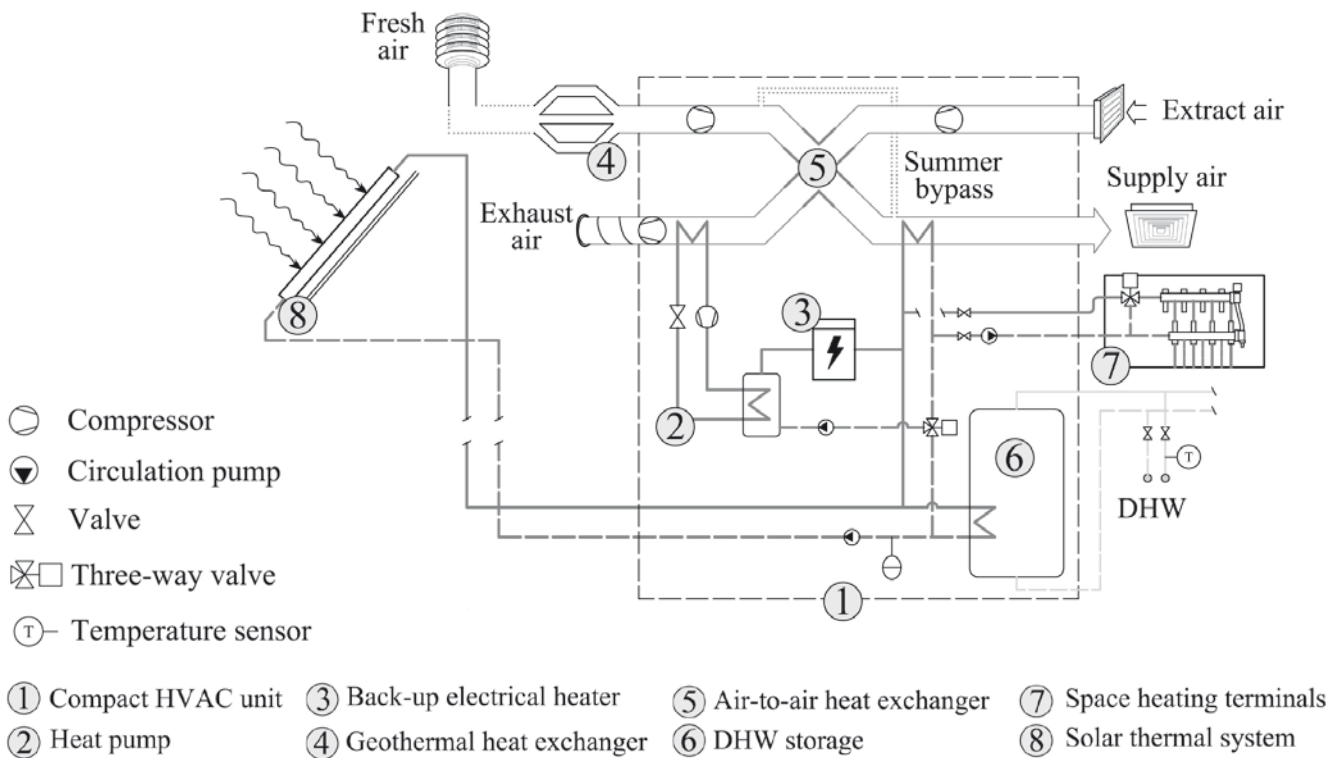

Figure 3. Schematic of an integrated system for ventilation, DHW production and hydronic space heating.

Multi-use multi-source heat storages

Storing energy in the form of sensible heat currently appears the most viable solution for bridging the gap between energy consumption and energy generation from various sources. With a view of optimising the exploitation of different energy sources (solar, biomass, etc.) and providing hot water at different thermal levels, multi-source multi-use water heat storages were designed and consist of different source side circuits fed by the energy source, different hydronic use side circuits (high temperature heating, low temperature heating, DHW production) and a controller. Lower coils receive heat from solar thermal, heat pumps or heat recovery from chillers condensers; intermediate coils receive heat from biomass boilers; upper coils produce DHW. Depending on the circuit, source sides and use sides can be connected hydraulically or by means of a heat exchanger. These storages rely on the thermal stratification of the water volume in order to improve the storage efficiency.

Heat pumps and the problem of the DHW production

In many cases, the heat pump is the preferred choice for a ZEB. Without entering into the various types of heat pumps that can be adopted (air-to-air, water-to-water, ground source, but also condensing boiler-heat pumps, gas absorption and gas engine), and into the calculations and feasibility studies necessary for each case, the main advantages of heat pumps are the possibility to be used for space heating and cooling, the possibility of producing DHW from heat recovery, the integration with solar thermal system and the good performance at part loads. A monographic number of REHVA Journal (5/2014) was recently devoted on heat pumps for ZEB. It is interesting to note here that the main problem to be faced when installing a heat pump for space heating into a ZEB is the production of the DHW.

Due to the many peculiarities of the DHW production within a ZEB context, such as the high thermal levels, the high design heating load (e.g. 18 kW for 10 l/min with a delta temperature 15°C - 40°C, the problems related to the proliferation of legionella and last but not least the integration with renewable sources, if electric heat pumps are used, the instantaneous production is not feasible and a storage volume is necessary to level the loads. The storage volume also allows adequate temperatures for both use and source (heat pumps) sides. Basically, three plant schemes can be designed:

- a DWH storage with an internal coil (water heater): the storage volume is designed on the DHW requirement, the coil should be appropri-



Figure 4. An example of a Stirling Engine CHP in a residential building.

ately sized and the problem of legionella should be addressed;

- a DWH storage with an external heat exchanger: the storage volume is designed on the DHW requirement, the external heat exchanger allows higher efficiency while there are two pumps and still the problem of legionella;
- a water storage and an instantaneous heat exchanger for the DHW production: in this case the storage volume is larger, there are always two pumps, but no risk of legionella proliferation.

Conclusions

Systems for ZEBs are usually integrated. The optimisation of their potential benefits requires a whole building approach, implemented since the design concept stage until the final design. To do this, appropriate manufacturer data should be made available in order to perform detailed calculations of the energy performance of the system. Currently, only synthetic data are usually available from manufacturers (e.g., design efficiencies, mean seasonal efficiencies calculated at reference conditions, etc.). This seems the greatest challenge facing up multi-energy system in the near future. Their spreading on the market will depend on the capacity to minimise the mismatch between expected (design) and real (monitored) energy performances. ■

References

- [1] J. Manwell, Hybrid Systems, Encyclopaedia of Energy, Elsevier
- [2] E. Fabrizio, F. Seguro, M. Filippi, *Integrated systems for HVAC and DHW production for Zero Energy Buildings*, Renewable and Sustainable Energy Reviews 40 (2014) 515-541.
- [3] W. Feist, J. Schnieders, V. Dorer, A. Haas, *Re-inventing air heating: convenient and comfortable within the frame of the Passive House concept*, Energy and Buildings 37 (2005) 1186-1203.

Now in Nominal Diameters
DN 15 to DN 150



Belimo Energy Valve™.

Know where the energy is going.

EXPERIENCE EFFICIENCY

Measuring, controlling, balancing, shutting and monitoring energy – the Belimo Energy Valve™ combines five functions into a single installation-friendly unit. Also unique are functions such as Delta-T manager or the possibility of direct power control. This provides clarity, increases efficiency and cuts costs.

- Quick and certain dimensioning, simple commissioning
- Time-savings through automatic, permanent hydraulic balancing
- Ensuring the correct volume of water with differential-pressure changes and partial loads
- Transparency with respect to energy consumption for heating and cooling

Find out now about this trend-setting valve technology for maximum comfort with minimum energy consumption.

Water is our element: www.belimo.eu

BELIMO Automation AG, Brunnenbachstrasse 1, CH-8340 Hinwil, Switzerland
Tel. +41 43 843 61 11, Fax +41 43 843 62 68, info@belimo.ch, www.belimo.com

BELIMO[®]

Modular heat pumps: Energy performance



MICHELE ALBIERI
Rhoss, Irsap Group
- Codroipo (Ud)
michele.albieri@rhoss.it



PIO FALDELLI
Rhoss, Irsap Group
- Codroipo (Ud)
pio.faldelli@rhoss.it



ATTILIO MASOCH
Rhoss, Irsap Group
- Codroipo (Ud)
attilio.masoch@rhoss.it



SILVIA MORASSUTTI
Rhoss, Irsap Group
- Codroipo (Ud)
Silvia.morassutti@rhoss.it

Heat pumps are ever more frequently being used as single generators in heating systems without being coupled to an emergency boiler. Reliability becomes a primary requirement to achieve without limiting energy efficiency. The best solution is represented by modular systems that are able to maximise seasonal energy indices, both with summer and winter operation, thus assuring the same reliability of a system with multiple generators.

Keywords: heat pumps, modular heat pumps, energy efficiency, renewable energies.

Heat pumps are generators more complex than boilers or traditional cooling units without cycle inversion. The complex nature is not to be considered a defect, if you are able to manage it, nor is it synonymous with poor reliability.

However, the spread of heat pumps in heating systems is very low compared to boilers, and the number of technicians able to intervene rapidly on any malfunction, even the most trivial, is still relatively limited. To assure the unit operating in any situation many designers choose double cooling circuit heat pumps, each equipped with an individual compressor in order to provide sufficient redundancy. It is unfortunately a poor solution, which

is explained in more detail in the following paragraphs, since you can only ensure complete reliability in every situation by increasing the number of generators.

HP requirements in heating systems

The widespread distribution of heat pumps as single generators in heating systems has mainly been in new, rather isolated buildings, thus having limited unit loads. This has enabled the use of low temperature terminals such as fan coil units and, especially, radiant systems. However, in order to extend the use of these types of generators and benefit from their energy efficiency to reach the targets of 20-20-20, it is also compulsory to work with radiators, which were the most commonly used terminals in heating systems in the past.

New buildings and buildings to restore

There are tens of thousands of buildings to restore in Europe, the majority of which are residential. The energy challenge of the future will be in renovating existing buildings, and the winner will be the one who proposes system-engineering technologies that can be installed with minimal interventions. Therefore, if you really want to promote the technology of heat pumps, they must be designed to also work with radiators.

Terminal power supply temperature

A floor radiating system requires water input temperatures between 35°C and 40°C, a radiator system built in the 70s was designed with input temperatures higher

than 70°C. The question is, how much can the supply temperature of the radiators be lowered, whilst keeping their same size, in order to use the existing terminals. Acting both increasing the building performances and introducing a VMC system a reduction in requested power is obtained and this permits to reduce the water temperature sent to the plant. The water input temperature in terminals with both a floor radiating system and a radiator system can reduce the thermal load according to the change in outdoor air temperature, as shown in **Figure 1**.

Performance of heat pumps in accordance with the temperature of thermal sources

Figure 2 shows the winter performance of a full load air hydronic heat pump in accordance with the temperature of thermal sources, or according to the change in outdoor air temperature and the produced water temperature. The produced water temperature affects COP, however, it is practically insignificant with regard to the power capacity.

From a viewpoint of machine size, it is advantageous since heat pump power is also essentially guaranteed by the requested production temperature of DHW, and to the lowest outdoor air temperature for radiator systems. On the other hand, COP deterioration requires proper management of the production temperature in accordance with the load and outdoor air temperature so as not to penalise seasonal efficiency too much.

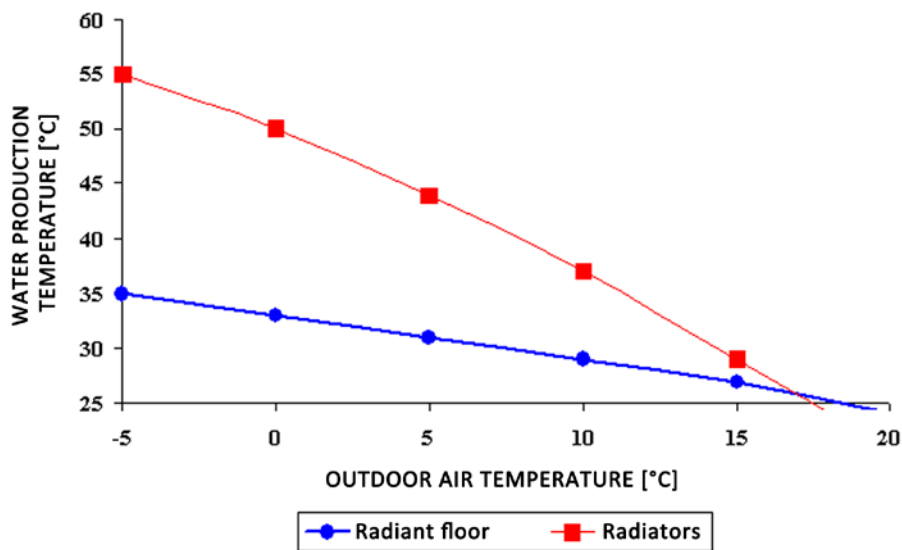

Figure 1. Floor radiating system (blue line) and radiator performance (red line) of water supply production temperature according to outdoor air temperature.

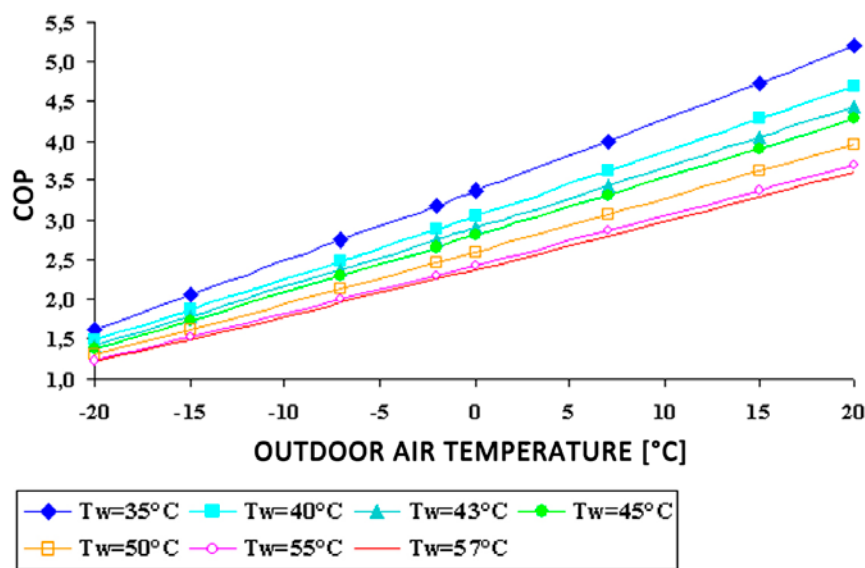
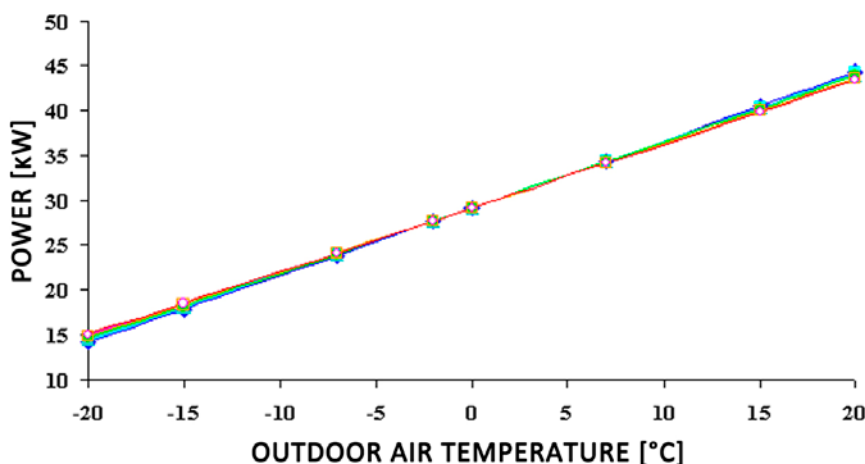

Figure 2. Full load winter performance of a heat pump with scroll compressors.

Search for energy reliability and efficiency

If the heat pump is the only generator supplying the heating and DHW system, it must be totally reliable. Choosing models with many refrigerant circuits clashes on the one hand with energy efficiency, and, on the other hand, with the presence of a single electrical panel and a single microprocessor that if breaks, it completely blocks the entire heat pump. **Figure 3** shows instead the increase obtained in the heat pump COP if the produced water temperature decreases according to the curve in **Figure 1**, instead of being constant at the maximum value (35°C for floor radiating systems and 55°C with radiators). This can be done with the predictive advanced software Adaptive Function Plus (AFP) patented by Rhoss, which enables the cooling unit to adapt itself to the actual load of the building (Albieri et al, 2007).

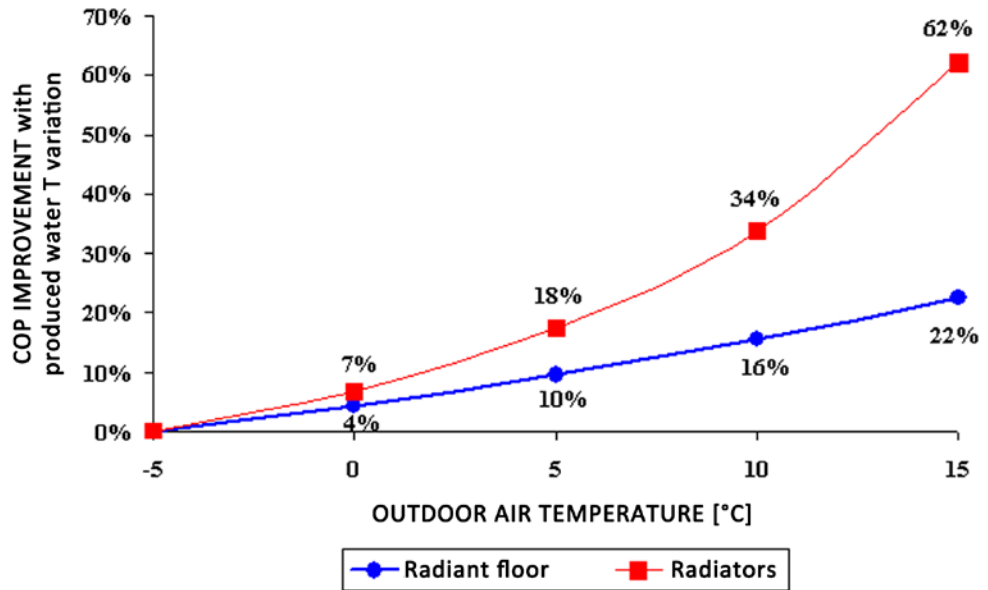

Figure 3. COP heat pump improvement if the production temperature follows the curve in Figure 1 instead of remaining constant.

Partialisation energy efficiency

Heat pump works at full load for short periods of time, while most of the time it works reducing its power so it's important to consider the average seasonal performances. The efficiency of the units is influenced by the number of steps per cooling circuit, the system water content, the defrost cycles (see **Figure 4**).

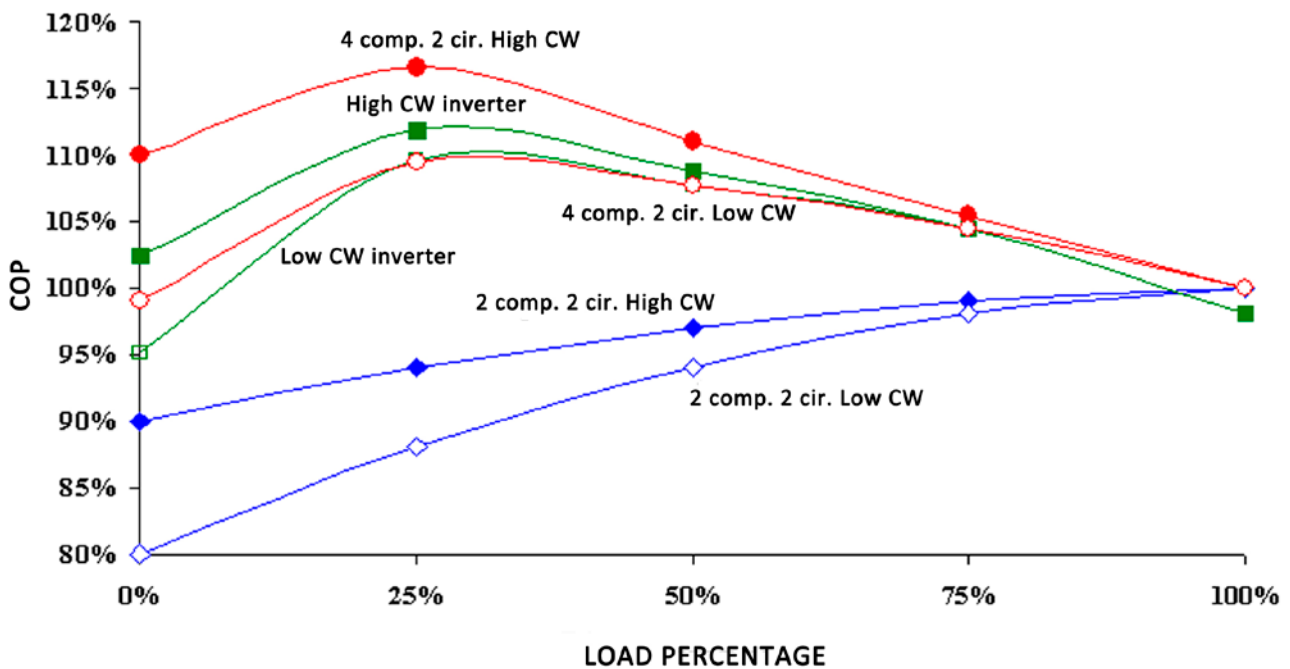

Figure 4. COP variation on percentage variation of the load (outdoor air temperature 7°C, produced water temperature 45°C), depending on the cooling circuit partialisation and the content of water (CW).

Total performance of COP during winter months

Figure 5 summarises what has been reported up to this point, since it shows the performance of different types of heat pumps considering the presence, or otherwise, of software able to adjust the produced water temperature required by the terminals, both with regard to the outdoor air temperature and the defrost cycles (highlighted by the discontinuity of the curves). The content of water in the system was considered high and humidity of outdoor air was always considered equivalent to 80%. In any case, the best performance is always obtained by modular systems described in the following paragraph 4.

EER performance during the summer season

Performance of the EER energy efficiency index during the summer season is very similar to that described for winter operation (Bacigalupo et al, 2000; Vio, 2006).

Advantage of modular systems

The best solution is represented by modular systems that are able to maximise seasonal energy indices, both with summer and winter operation, thus assuring the same reliability of a system with multiple generators.

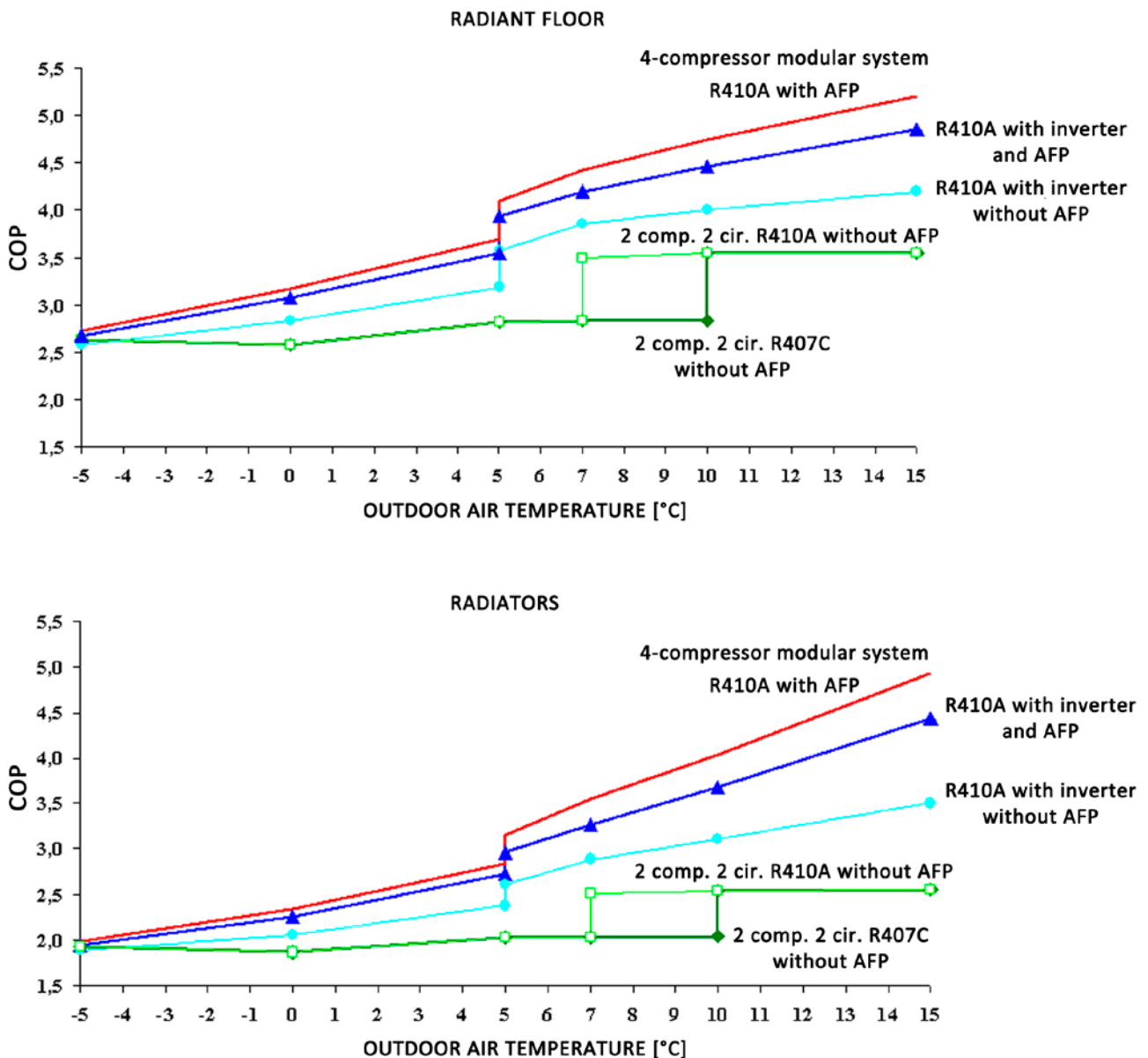

Figure 5. Total winter performance of different types of heat pumps.

The Poker modular system

Poker is an innovative line of modular heat pumps that are able to combine main features such as noiselessness, flexibility, and energy efficiency. Poker consists in independent 34 kW thermal modules, which, connected to, each other, generate an overall power of 137 kW. Each individual module is an air-water reversible heat pump equipped with a scroll compressor with tandem configuration and R410A refrigerant. The units are easy to install, both from a hydraulic and electrical viewpoint.

System configuration

The modular system is able to produce hot/cold water for the system and DHW with different configurations (3-way diverter valve or heat recovery).

It gives also many advantages:

- Partialisation energy advantages
- Energy advantages due to the patented adjustment logic Adaptive Function Plus
- Energy advantages due to the presence of partial recovery
- Total redundancy of components
- Reduction of the amount of refrigerant per individual circuit

Energy and economic analysis: a few practical cases

Hereunder is a report of data obtained regarding three similar buildings situated in three different Italian locations with very different climates: Milan, Rome, and Catania. The analysis was carried out using Energy Plus software. **Table 1** shows the energy requirements in the buildings taken as an example.

Table 1. energy requirements in the buildings taken as an example (kWh).

	Milan	Rome	Catania
Heating Requirements	58,025	46,555	33,998
DHW Requirements	21,827	21,827	21,827
Cooling Requirements	15,062	25,155	25,352

Table 2. Seasonal energy efficiency in the cases taken into consideration.

		HP 2 compressors 2 circuits without AFP	HP 2 compressors 2 circuits with an inverter without AFP	Modular system 2 modules 4 compressors 2 circuits with AFP
SCOP	MILAN radiators	2.20	2.51	3.42
	MILAN floor	3.71	4.24	4.74
	ROME radiators	2.33	2.70	4.23
	ROME floor	3.93	4.40	5.00
	CATANIA radiators	2.59	2.85	4.69
	CATANIA floor	4.35	4.79	5.55
SEER	MILAN	3.32	3.68	4.17
	ROME	3.17	3.51	3.91
	CATANIA	3.30	3.67	4.14

Five different generators were compared, each one applied to two types of heating systems (floor radiating and radiators), while summer cooling was taken into consideration in all cases with a fan coil system.

Table 2 shows the seasonal efficiency values obtained from the various types of heat pumps. The observation

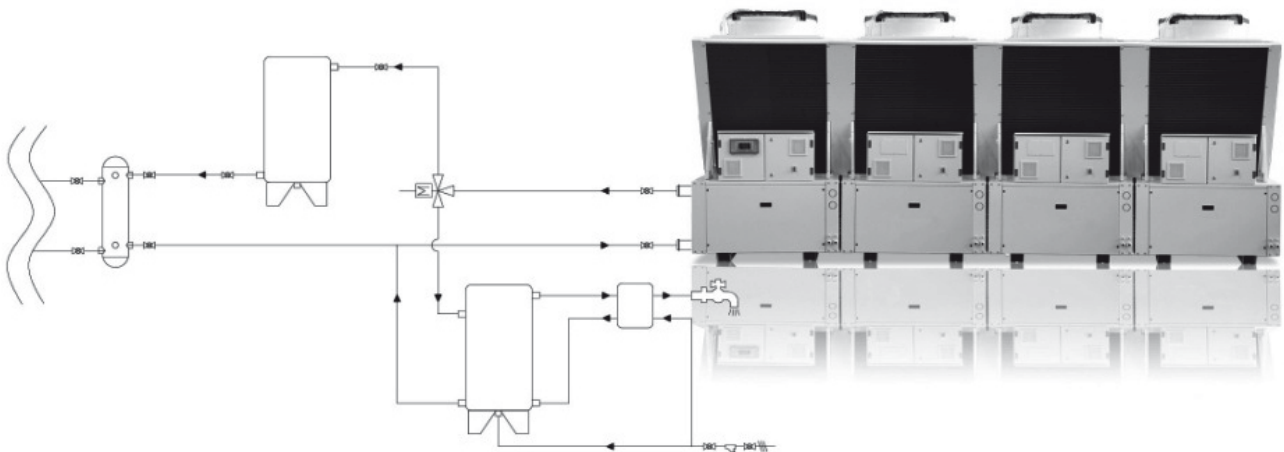

Figure 6. Example of separate production of domestic hot water and hot/cold water for the system.

Table 3. Work costs (€) in the considered cases (cost of methane 0.80 €/m³, cost of EE 0.20 €/kWh).

		Methane boiler	HP 2 com 2 circ no AFP	HP 2 com 2 circ inverter no AFP	Poker system 2 modules	Poker system 2 heat recovery modules
MILAN	Radiator Heating + DHW	6,856	6,941	6,293	5,034	4,932
	Floor Heating + DHW	6,626	4,794	4,403	4,089	3,987
	Cooling		907	818	722	722
ROME	Radiator Heating + DHW	5,901	5,601	5,056	3,800	3,637
	Floor Heating + DHW	5,716	3,974	3,720	3,461	3,298
	Cooling		1,587	1,431	1,287	1,287
CATANIA	Radiator Heating + DHW	4,854	4,157	3,918	2,966	2,782
	Floor Heating + DHW	4,719	3,095	2,952	2,741	2,558
	Cooling		1,536	1,372	1,225	1,225

of **Table 2** helps us to understand the energy advantages of a modular system compared to the other types of heat pumps.

The energy advantages are also translated into economic advantages, as shown in **Table 3**. As we can note, economic savings are always very high with radiator systems, especially thanks to the ability of modular systems to produce water at the precise requested temperature of the system.

It is interesting to point out how modular systems in Rome and Catania, which are applied to radiator systems, obtain better economic results compared to heat pumps without logic adjustment AFP (also with inverters) connected to radiant systems.

This shows that it is possible to save energy and money without substantial initial investments, especially when considering that the cost of a modular system is in line with that of a monobloc unit having the same power, thus leaving the existing system unchanged or, at most, changing them with new radiators.

Conclusions

The diffusion of heat pumps in heating systems has just begun and may be successful if the products proposed by manufacturers can be also fitted onto traditional radiator systems. Memory has shown how important it

is to work on energy efficiency, especially by optimising performance of heat pumps in partialisation and using software that is able to reduce the temperature of water production according to actual system requirements. Similarly, if the heat pump is to be the only generator present, it must be completely reliable under any operating condition: modular systems are the best solution to fulfil these requirements. ■

References

1. M. Albieri, L. Cecchinato, A. Beghi, C. Bodo, 2007 "Nuovo algoritmo per l'efficienza energetica", CDA article no.9 October 2007, pp 52 - 58.
2. E. Bacigalupo, C. Vecchio, M. Vio, M. Vizzotto, 2000 "L'efficienza media ponderata dei gruppi frigoriferi a compressione: la proposta AICARR per un metodo di calcolo", Milan AICARR convention proceedings.
3. M. Vio, 2006: "La frontiera dell'efficienza energetica: il comportamento dei gruppi frigoriferi condensati ad aria ai carichi parziali" Milan Aicarr convention proceedings, March 2006: "Tecnologie, Norme, Mercato: Responsabilità, Rischi e Opportunità", pp 113 - 160.
4. M. Vio, D. Danieli 2008: "Le centrali frigorifere", Delfino Publishing, second edition.
5. M. Vio, M. Rigo 2010: "Impianti idronici e sistemi VRF-VRV: un confronto ragionato in 70 domande", Delfino Publishing, questions from 18 to 23.

Energy performance of radiators with parallel and serial connected panels



MIKK MAIVEL

Tallinn University of
Technology
mikk.maivel@ttu.ee

MARTIN KONZELMANN

WTP Wärmetechnische
Prüfgesellschaft mbH
mailbox@WTP-Berlin.de



JAREK KURNITSKI

Tallinn University of
Technology
jarek.kurnitski@ttu.ee

This study reports measurement and simulation results for radiators with parallel and serial connected panels conducted to quantify a possible energy saving of Serial radiator. The effect of radiant temperature was possible to see, but in terms of energy savings there was no considerable difference between studied radiators. The results do not support previous claims of about 10% energy saving.

Keywords: water radiator, heat emission, energy performance, operative temperature, radiant temperature.

Emission losses of heat emitters are important topic especially in the case of low energy buildings. It is reported that radiators with serial connected panels can provide 11% energy saving (Therm X2 technology) and this has been argued with up to 100% higher radiation heat transfer and also shorter heating up time of radiator. In the case of serial connected panels, the hot water flows first through the front (room-side) panel and then to the back (wall side) panel, **Figure 1**. The cooled water then returns to the heating pipework. The idea of serial connection is to increase the room side surface temperature of the radiator which will increase radiation heat transfer and operative temperature.

The objective of this study was to quantify the effect of parallel and serial connected radiator panels on emission losses and energy use with controlled laboratory measurements and dynamic simulation.

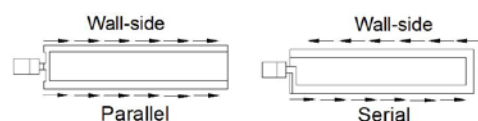

Figure 1. Studied radiator types with parallel and serial connected panels.

The motivation was to show which differences can be measured in the laboratory and how these can be generalized to annual energy performance of conventional and low temperature radiator systems.

The limitation of the heat emission standard EN15316-2.1: 2007 is that the calculation procedure is fully based on air temperature. In reality different radiators have some effect on radiant temperature and the operative temperature is the basic parameter of thermal comfort standard ISO 7730:2005. The operative temperature is calculated as an average of air and means radiant temperature and is the temperature a human being is sensing. For exact comparison, the measurements and simulations are needed to be conducted at the same operative temperature, which was taken into account in this study.

Heat output and temperature measurements

Heat emissions of two radiators were measured in the test chamber with cooled surfaces conforming EN 442-2:2003 requirements. The radiators were 2-panel radiators physically of the same size, 0.6 m height and 1.4 m length, with parallel and

equal operative temperatures, the heat output of Serial radiator was by about 2% smaller and 4% higher in Test 1 and 2 respectively (the effect of the adjustment about 1%). Analytically calculated net radiation from the front panel of radiators was 120 W and 148 W for Parallel and Serial, corresponding to 15% and 18% radiation share respectively.

Table 1. Analytically calculated adjusted values of temperatures and heat outputs of radiators.

	Test 1	Test 1	Test 2	Test 2
	T_{op} 19.39, 19.58	T_{op} 19.58, 19.39	T_{op} 19.33, 19.51	T_{op} 19.51, 19.33
Air, $T_{a, adjusted}$, °C	20.16	20.00	20.05	19.90
Cooled surf., $T_{s, adjusted}$, °C	18.58	18.28	18.58	18.29
Parallel 50°C, heat output, W	815.1	824.9	713.1	722.4
Serial 50°C, heat output, W	798.7	807.3	745.0	752.7
Saving of Serial, %	2.01	2.14	-4.48	-4.20

The tests at 70°C flow temperature corresponded to oversizing of radiators by about factor 2 (roughly 1 600 W vs. 800 W). Initial room temperatures were reasonably close in tests with both radiators which enabled an exact comparison of dynamic response during the heating up step change of about 3°C. In the case of Parallel, initial room air and surface temperatures were about 0.1°C lower, but Parallel radiator reached to the same temperature as Serial in 9 minutes. After that the air temperature curves were almost identical with slightly higher maximum value for Parallel at 43 minutes, **Figure 6**. After the heating up phase the thermostat valve was not able to keep stable temperature in both cases because of oversized radiators.

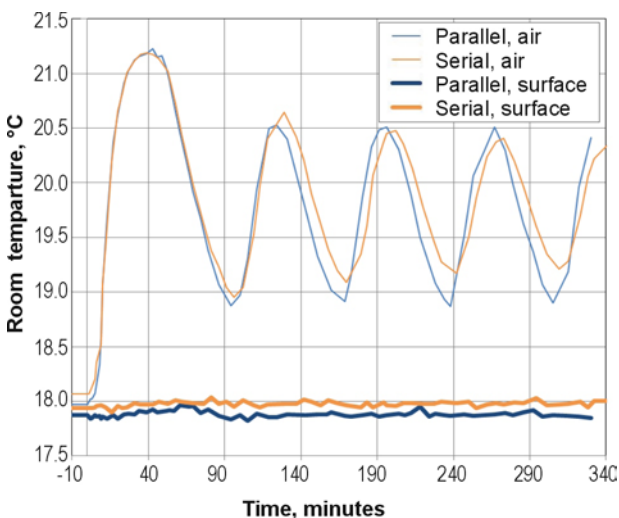

Figure 6. Dynamic step response of the room air and surface temperatures in 70°C Test 1.

Case study in a dynamic simulation environment

IDA-ICE simulation software with standard water radiator model was used to model the EN 442-2 test room and a typical residential room with the same dimensions. In the case of the test room, the radiator was located on internal wall and other 3 walls, floor and ceiling were external ones, **Figure 7**. In the case of a residential room the radiator was located on external wall with a window and there was also another external wall. The residential room had exhaust ventilation without heat recovery. The simulation was run at -22°C outdoor temperature to compare the differences in heat outputs and all year round with Estonian TRY for annual heating energy.

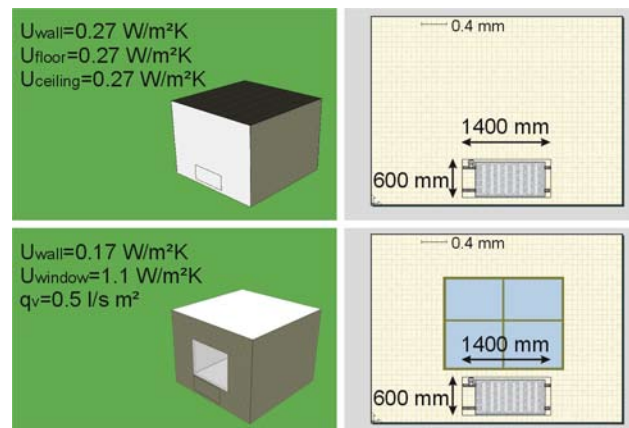

Figure 7. Simulated EN 442-2 room (upper) and a residential room (lower) in IDA-ICE model.

In the simulation a PI controller was used which kept the operative temperature set point of 19.5°C with high accuracy. In the case of EN 442-2 test room the U-values were selected so that heat losses were about 800 W at outdoor temperature of -22 °C. The IDA-ICE radiator model provided identical front panel surface temperature for Parallel radiator when return temperature was about 6°C higher than that in the measurements. To achieve the measured front panel surface temperature of Serial radiator the flow temperature was increased to 57.6°C. With these settings, the front panel surface temperatures were the same as in the measurements for both radiators and the simulation resulted in nearly the same heat emission of radiators, **Table 2**.

In the case of a residential room, heat losses of about 630 W were slightly smaller compared to 800 W in the laboratory tests and some adjustment in flow temperatures was needed to have identical front panel surfaces temperatures. Simulated heat outputs show the difference of 1.9 W corresponding to the saving of 0.3% by Serial radiator, **Table 3**. In annual energy simulation

Table 2. Simulation results of EN 442-2 test room described in Ch. 2.3. All values at -22°C outdoor temperature.

	Parallel	Serial
Flow temperature, $^{\circ}\text{C}$	50.0	57.6
Return temperature, $^{\circ}\text{C}$	39.8	43.4
Front panel surface temperature, $^{\circ}\text{C}$	39.8	44.1
Rear panel surface temperature, $^{\circ}\text{C}$	39.8	44.1
Air temperature, $^{\circ}\text{C}$	20.69	20.58
Front panel q_{front} , W	178.7	227.1
Convection q_{c} , W	624.7	576.2
Back side q_{b} , W	0	0
Total heat output q_{tot} , W	803.4	803.3

Table 3. Simulation results of a residential room described in Ch. 2.3. All values are at -22°C outdoor temperature, except the annual energy use.

	Parallel	Serial
Flow temperature, $^{\circ}\text{C}$	53.0	58.7
Return temperature, $^{\circ}\text{C}$	38.3	43.1
Front panel surface temperature, $^{\circ}\text{C}$	39.9	44.1
Rear panel surface temperature, $^{\circ}\text{C}$	39.9	44.1
Air temperature, $^{\circ}\text{C}$	19.61	19.48
Flow temperature for backwall correction, $^{\circ}\text{C}$	57.7	53
Rear panel surfaces temperature at corrected flow temperature, $^{\circ}\text{C}$	41.4	38.4
Front panel q_{front} , W	179.2	227.7
Convection q_{c} , W	446.8	396.8
Back side q_{b} , W	8.6	9.2
Corrected back side $q_{\text{b, corrected}}$, W	8.8	8.4
Total heat output q_{tot} , W	634.6	633.7
Corrected total heat output q_{tot} , W	634.8	632.9
Annual heating energy use, $\text{kWh}/(\text{m}^2 \text{ a})$	64.9	64.5

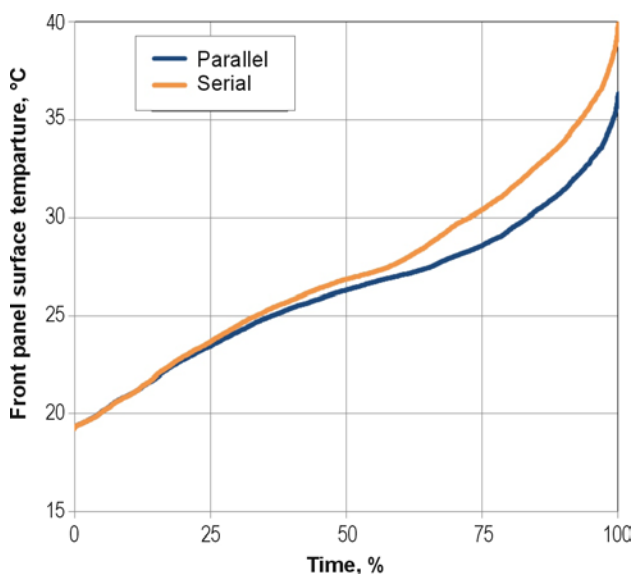

Figure 8. Duration curve of the radiator front panel surface temperatures (100% = 8 760 h).

Serial radiator provided heating energy saving of 0.7% and slightly higher front panel surface temperature as shown in **Figure 8**.

Conclusions

- Laboratory measurements showed in the first test 3% lower and in the second test 3% higher heat emission of Serial radiator. The differences between the tests were higher than the declared accuracy of the EN 442-2 test room of $\pm 1\%$ and were caused by very small but continues swings in water flow rates and temperatures. The measurement setup used did not reached the complete steady state and was not able to quantify the differences between tested radiators, however indicating that these differences were very small if they existed at all.
- Simulated results of EN 442-2 test room with front panel surface temperatures of radiators identical to the measured values showed 0.11°C lower air temperature in the case of Serial radiator, but exactly the same heat emission of both radiators, because of more intensive radiation heat exchange in the case of Serial radiator.
- Simulated results of a typical residential room showed by 0.3% smaller heat emission at design outdoor temperature and by 0.7% smaller annual heating energy use in the case of Serial radiator. Therefore the radiator on external wall with higher front panel temperature resulted in a quantifiable energy saving approving the importance of radiant temperature as phenomena, but in terms of energy savings there was no considerable difference between studied radiators with parallel and serial connected panels.
- Serial radiator had 4°C higher temperature of the front panel that resulted in slightly higher radiation share, 18% relative to 15% for Parallel radiator in 50°C test. The rear panel temperature of Serial radiator was by 3°C lower that may have some energy saving effect in the case of poorly insulated walls.
- Parallel radiator showed slightly faster dynamic response and higher heat output which resulted in slightly faster heating up time. By 3% higher heat output of Parallel radiator at ΔT 50 K increased to about 10% higher heat output at ΔT 25 K which gives some advantage to Parallel radiator in low temperature heating systems. ■

References

Please see the complete list of references of the article in the html-version at www.rehva.eu
-> REHVA Journal

All-in-one high-performing system for ZEB houses



MARIA FERRARA
Grant researcher
TEBE Research Group
Energy Department
Politecnico di Torino at Turin, Italy
maria.ferrara@polito.it



FREDERIC KUZNIK
Full professor
CETHIL, UMR 5008,
INSA of Lyon, at Villeurbanne,
France
frederic.kuznik@insa-lyon.fr



JOSEPH VIRGONE
Full professor
CETHIL, UMR 5008
INSA-Lyon, Université Claude-Bernard
Lyon 1 at Villeurbanne, France
joseph.virgone@insa-lyon.fr

The construction of nearly Zero Energy Buildings implies not only a good envelope design, but also the use of highly efficient systems for heating, cooling and mechanical ventilation. This paper describes a good practice example where the high performance of the all-in one HVAC system was studied through dynamic simulation and resulted in a cost-effective high performance.

Keywords: nZEB, dynamic simulation, monitoring, reversible heat pump, mechanical ventilation, canadian well, France.

The Corbioli House is a single-family house situated in Ambérieu-en-Bugey, in the French region of Rhône-Alpes. It was built in 2011 by the construction company “Maison and Résidence Corbioli”. This area is classified by the French thermal regulation RT2012 [1] as a H1c zone, where the C_{max} for residential buildings is equal to 60 kWh_{ep}/year [2]. Because of its bioclimatic design and its innovative and efficient HVAC system, the house represents a good practice for high-performing single-family houses in that region, which is a low altitude area with temperate climate.

A bioclimatic design

The Corbioli House is a two-floors residential building of which the total gross floor area is equal to 155 m².



Figure 1. Picture of the Corbioli House, south front (left) and north front (right).

Coherently with principles of passive houses, in order to reduce heat loss due to windows and benefit of solar gains, the maximum of large openings are south-oriented (49% of total glass surface on the south external wall, 19% on the south roof slope) while the percentage of openings in east and west orientation is less relevant (respectively 10% and 15%) and there are only very small north oriented openings (7%). Window area is approximately 1/5 of the floor area: the minimum imposed by the national regulation, which is equal to 1/6 of the floor area, is largely exceeded. A roof overhang protects south-oriented windows. The heated volume (**Figure 2**) has a compact shape that minimizes the exchange surface between the outside and inside (Surface/Volume ratio is equal to 0.68 m^{-1}).

The envelope is well insulated (**Figure 3**): the external walls are composed by 20 cm of concrete blocks (thermal resistance $R = 1 \text{ m}^2\text{K}/\text{W}$) and 20 cm of internal insulation

($R = 6.3 \text{ m}^2\text{K}/\text{W}$), the wooden roof includes 40 cm of insulation ($R = 12.5 \text{ m}^2\text{K}/\text{W}$) and the floating slab incorporates 30 cm of insulation material ($R = 9.3 \text{ m}^2\text{K}/\text{W}$). The use of thermal bridge breakers limits the thermal bridge at the intermediate floor. All windows have triple glazing for a thickness of 44 mm (4/16/4/16/4), the solar factor is equal to 0.5 and the thermal transmittance U_w of the entire opening (glasses and frame) is equal to $0.7 \text{ W}/\text{m}^2\text{K}$. A blower door test attested the air tightness of the house equal to $0.6 \text{ m}^3/(\text{h m}^2)$.

A compact HVAC system

The house is equipped with the Tzen-3000 system, provided by Aldes [4], (**Figure 4**), which is composed of a mechanical dual flow ventilation system combined to a cross flow heat exchanger and an air-air reversible heat pump that are included in the thermodynamic central C3000 (**Figure 5**). Before joining the distribution ducts, after the heat pump, the fresh air passes

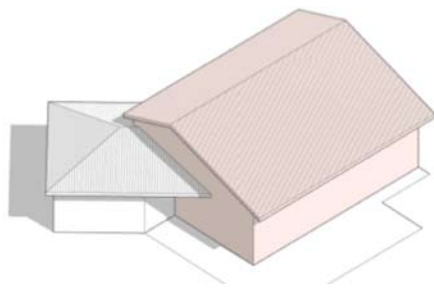

Figure 2. Volumetric representation of the Corbioli House. The heated volume is coloured in orange.

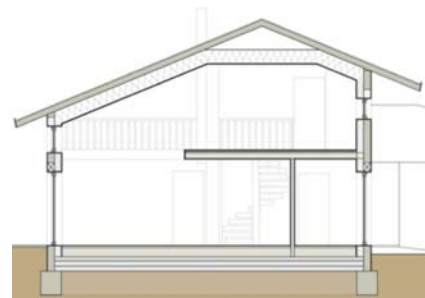

Figure 3. Corbioli House, transversal section.

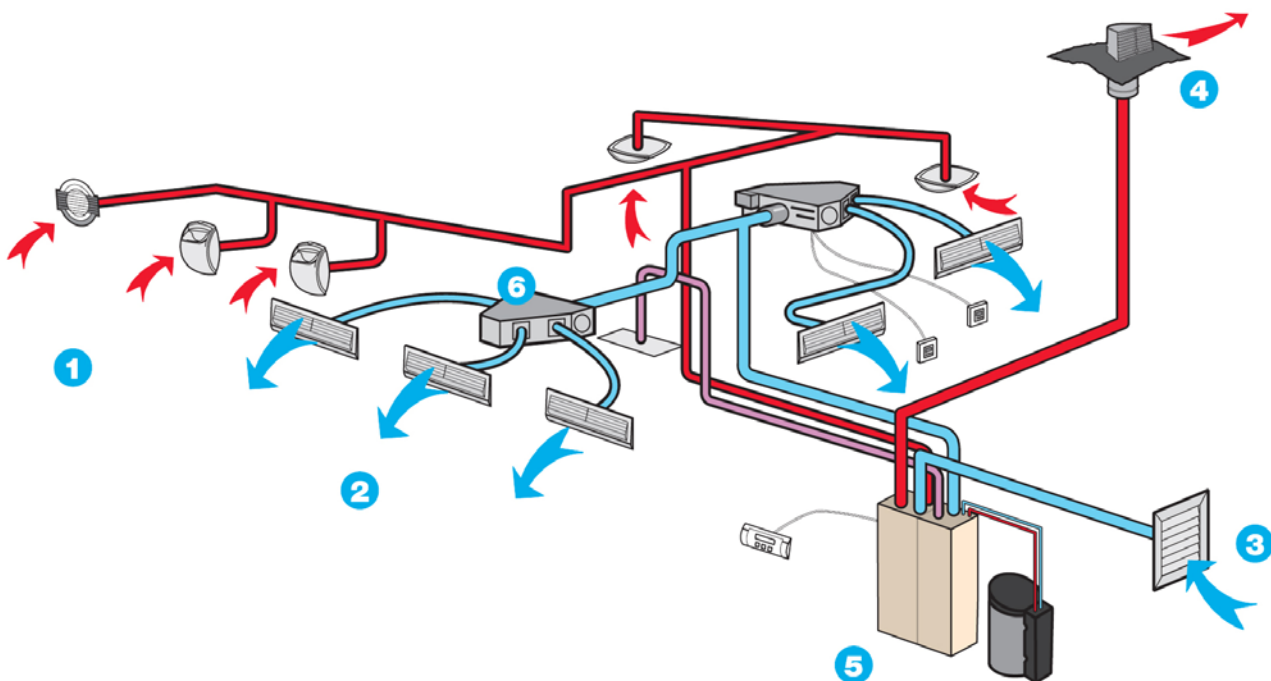

Figure 4. T-zen. (1) Extraction, (2) Blowing, (3) External air, (4) Exhaust air, (5) Central, (6) Heating module. (Aldes)

through the auxiliary modules (one module per floor) that allow the temperature regulation room by room, while providing additional heating sometimes required in winter. Each duct of the heating module is indeed equipped with an electric battery that is controlled by a thermostat disposed in the room to which the same duct is connected. The entire system can be controlled using a keyboard located in the kitchen, and thermostats in other rooms. Once the set point temperature is given, the system automatically manages the comfort through the perfect control of flows induced by ventilation while providing air to guarantee internal comfort regardless of the season. The technical documentation specifies that for a 5-room house with two bathrooms, a shower room and a separate WC the standard airflow rate is equal to 150 m³/h, reaching 240 m³/h in peak flow and dynamically varying according to the operation mode.

The all system in the Corbioli House is controlled according to the following conditions:

- The winter set point temperature is fixed to 19°C in all conditioned zones;
- The difference between the ambient temperature and the inlet air temperature is controlled adjusting the recycling rate in order to not exceed 20°C;
- In order to avoid the frequent switch between different operation modes, the limit to differentiate the warm period and the cold period is set to 22°C for indoor temperature with a 3°C dead band hysteresis cycle;
- The heat exchanger is by-passed in the cold period and in hot period when the outdoor temperature exceeds the indoor temperature;
- The building is subjected to hyperventilation in hot period when the outside temperature is below 24°C and the inner one is higher 24°C.

Given this regulation scheme, a calibrated model of the whole building was built in order to simulate and study the HVAC system behaviour in the three different operation modes.

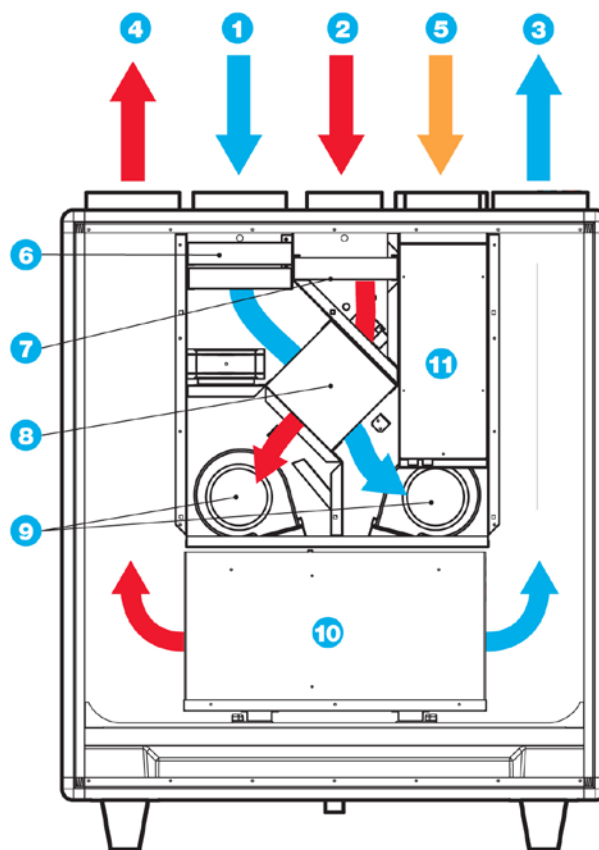

Figure 5. C3000. (1) External air, (2) Extract air, (3) Fresh air, (4) Exhaust air, (5) Additional extract air, (6) Fresh air filtration, (7) Extract air filtration, (8) Heat exchanger, (9) Fans, (10) Heat pump, (11) Electronic card. (Aldes)

Heating mode

In winter, the temperature control system is generally set to the heating mode, and the heat pump is on. The cross flow heat exchanger included in the thermodynamic central is able to recover 60% of heat from the extracted air. The heat pump heating power varies depending on the outdoor temperature, the desired indoor temperature and the flow rate. The coefficient of performance (**Table 1**) also varies in relation to the combination of all these parameters, going up to 8 in particular conditions.

Table 1. Heat pump COP in function of indoor and outdoor temperatures, air flow rate and compressor speed.

Outdoor temperature	Indoor temperature	Flow rate m ³ /h	Compressor speed	Recyclage	Heating power	Global COP
-7°C	20°C	160	20 Hz	No	1663 W	7,6
			60 Hz	Yes	2861 W	4,2
			80 Hz	Yes	3220 W	3,4
7°C	20°C	160	20 Hz	No	1130 W	5,1
			60 Hz	Yes	2881 W	3,4
			80 Hz	Yes	3468 W	2,8

In a typical French winter period, the outside temperature may reach -10°C . The higher the heating need, the higher the heat pump compressor speed is and the higher the outlet air temperature is requested. In order to maintain the indoor temperature equal to 19°C , the outlet air temperature can go up to 70°C . However, for comfort reasons, the difference between the outlet air temperature and the air temperature of the room cannot exceed 20°C . That is why a recycling system for indoor air

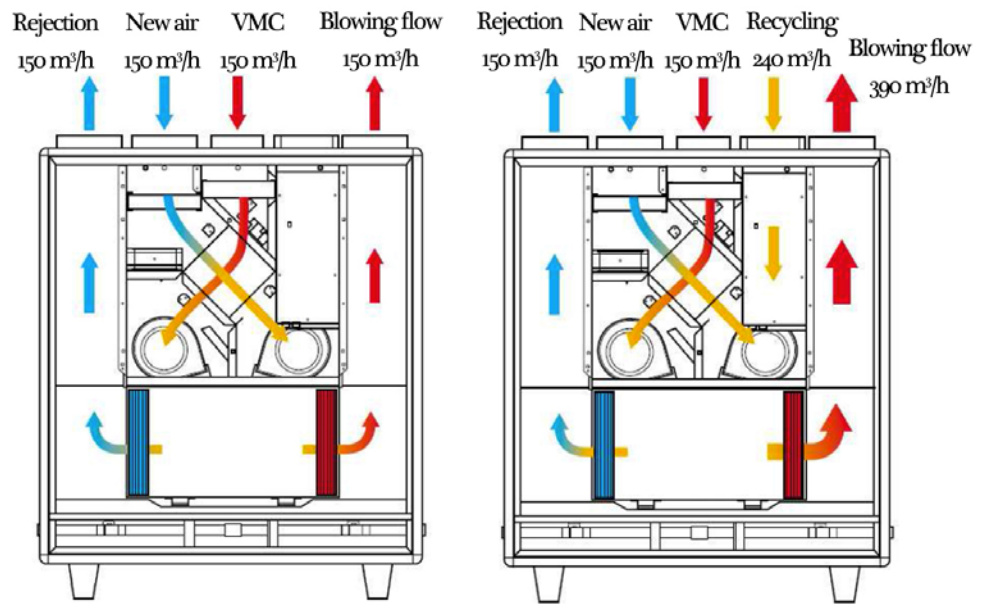

Figure 6. C3000. (Left) Heating mode without recycling, (Right) Heating mode with recycling.

is set up to maintain the temperature difference to 20°C maximum. The recycled air, mixed to the fresh air leaving the heat pump, lowers the outlet air temperatures while increasing the air flow, as shown in **Figure 6**. Moreover, as already mentioned, the T-Zen system is able to adjust outlet temperatures in each room. If in some rooms the air temperature is lower than the set-point, the auxiliary heating modules start working in order to adjust the temperature to the set-

point value. Heating modules should start only when the heat pump is not enough to maintain the required temperature. The **Figure 7** reports the global operation of T-zen in January: thanks to the perfect balance of the volume and the temperature of the blowing air flow, the indoor temperature is maintained to 19°C and the blowing air temperature never exceed 38°C , while the heat pump power varies depending on outdoor temperature.

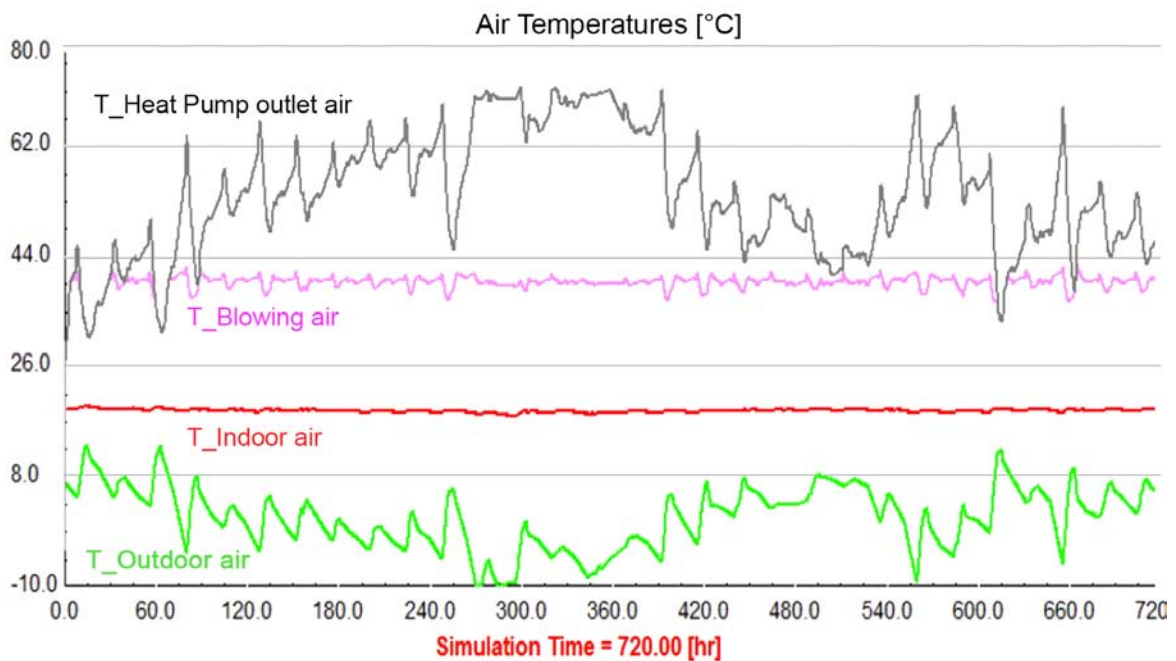

Figure 7. T-zen in January. Outdoor temperature (green), Indoor temperature (red), blowing air temperature in the living room (pink), heat pump power (black).

Cooling mode

In summer period, the T-zen works in cooling mode and the heat pump reverses its cycle and cools the air entering the house. Its cooling power and COP also varies depending on the outdoor and indoor temperature, the flow rate and the compressor speed. In addition, a system of over-ventilation is implemented when the outside air is cooler than the indoor air (particularly at night). Finally, the heat exchanger can also be switched on if the internal temperature is colder than the outside temperature; in such a way it helps cooling the fresh air. The over-ventilation rate corresponds to the maximum speed defined above, 240 m³/h, and the bypass of the heat exchanger is switched on when the over-ventilation starts. This is controlled with a hysteresis effect, which prevents the over-ventilation system from switching on/off too frequently. The T-zen operation in a typical summer month (from 8/6 to 7/7 of year 2013) is shown in **Figure 8**, where the over-ventilation starts working at the early night and stops later, in order to reduce the phenomenon of overheating during the day while avoiding a too low temperature in the night. Moreover, when the indoor air is cooler than the outside air the exchanger cools the inlet fresh air with the inside outlet air. In **Figure 9**, the evolution of the outdoor temperature, the indoor temperature, and the fresh air temperature at the outlet of the heat exchanger in the same period are shown. The heat exchanger is able to cool the fresh air when the outside temperature is too high, with peaks of 3°C of temperature decrease.

Ventilation only mode

The ventilation only mode allows mediating between the heating mode and the cooling mode, when heating or cooling requirements are very low, typically in spring and autumn. In this case, the heat pump never turns on and the air can only pass through the heat exchanger. When the house requires a small supply of heating energy, the heat exchanger turns on and allows heat recovery from exhaust air. However, when the temperature of the house is too high, the heat exchanger is bypassed and the temperature of the blowing air is therefore the same temperature of the outside air. As usual, the control system allows a hysteresis effect, which prevents the exchanger from switching on and off too frequently.

The Canadian well

The presented T-zen system is coupled to an underground heat exchanger. It consists in pre-treating the external fresh air through pipes buried in the ground, before it enters the HVAC system: the principle is to make passive use of geothermal energy (**Figure 10**). In winter, the deep soil is warmer than the outside temperature, and therefore the cold air is preheated as it passes through the pipes. In summer, the soil is colder than the outside temperature and is able to warm the temperature of the air input, sometimes allowing cutting down the air conditioning. The more the pipes are deep and long, the more efficient is the system. In the case of Corbioli house, the diameter of pipes is 200 mm and the length is 30 m. It is placed in the garden soil at a depth between 1.5 m e 2.6 m: the 2% slope is necessary for the condensation water drainage.

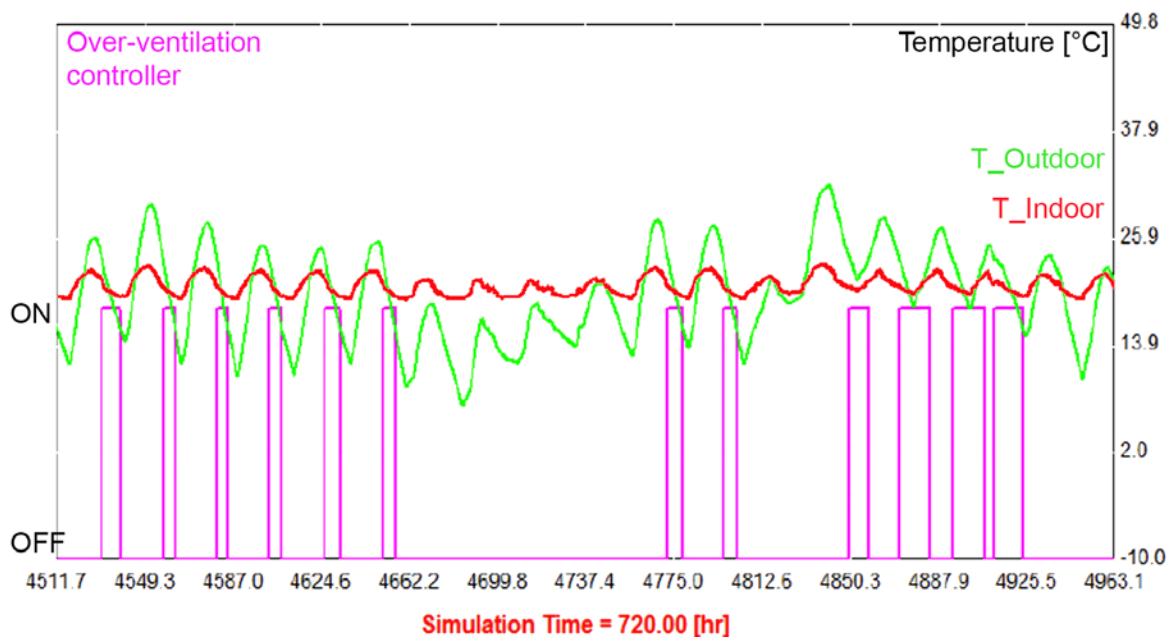

Figure 8. T-zen cooling mode (2013, 8/6-7/7). Outdoor temperature (green), Indoor temperature (red), Over-ventilation on/off (pink).

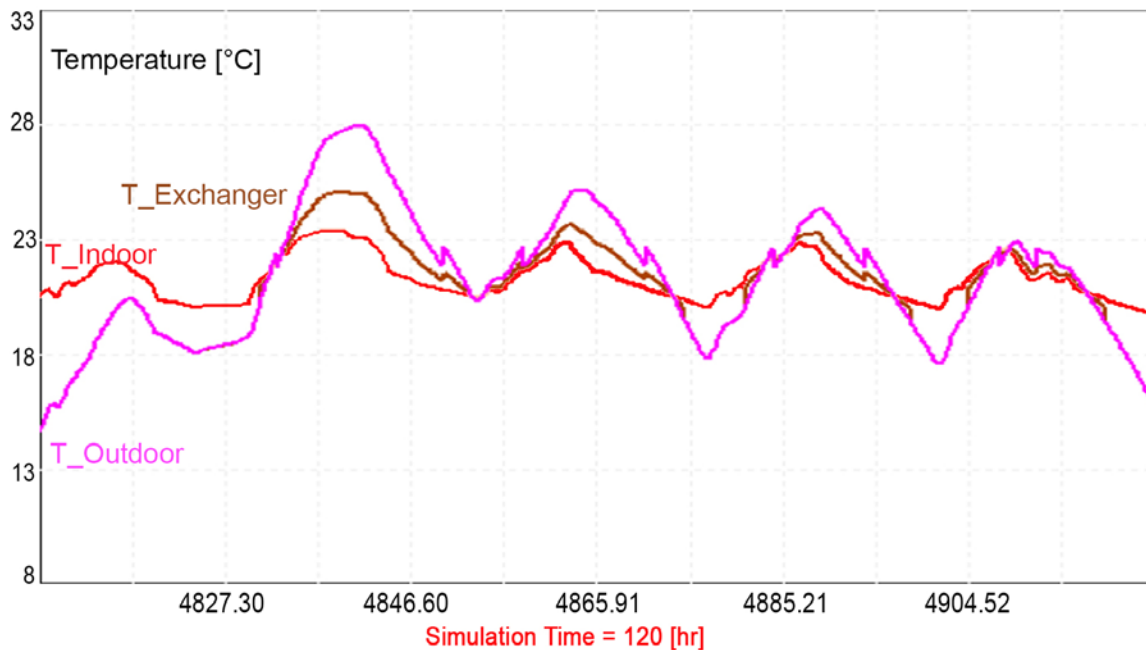

Figure 9. Heat exchanger benefits in cooling mode. Outdoor temperature (pink), Indoor temperature (red), heat exchanger output temperature (brown).

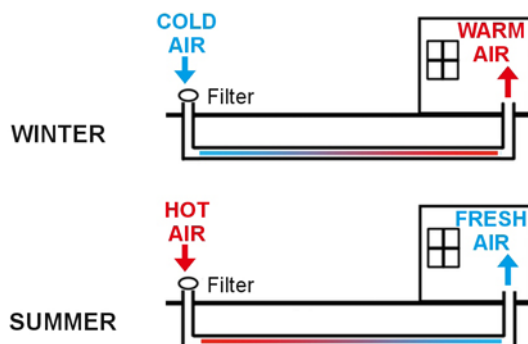

Figure 10. Canadian well operation in different seasons.

The total building energy performance

As mentioned, the study of the Corbioli House was studied through building model and dynamic simulation has been used to evaluate the energy performance of the Corbioli house. As the house is currently unoccupied, the internal loads related to lighting and appliance (8 W/m² in main rooms) and occupancy (100 W/person) were modelled using schedules for a standard 5 people family working life, considering weekends. The sum of infiltration and ventilation rate is fixed equal to 0.7 ach in all building. Given these conditions, without considering the HVAC system, the sensible heating demand of the Corbioli House is equal to 48 kWh/m²/year, while the cooling demand was estimated to be 12 kWh/m²/year. If a traditional French all-electrical system (radiators for heating, fans for cooling and no mechanical ventilation) would be installed in the house, the total annual primary energy consumption would be equal to

134 kWh_{ep}/m²/year, considering the French primary energy conversion factor of 2.58 and the efficiency of the cooling system equal to 3. However the T-zen HVAC system allows the estimated annual energy consumption for heating, cooling and ventilation to be equal to 12.59 W/m²/year, leading to a total primary energy consumption of 32.5 kWh_{ep}/m²/year, fully meeting the current regulatory requirements [1]. This low energy demand can be covered by an on-site renewable energy production plant (PV and solar), leading the Corbioli House to be close to the target Zero Energy.

The financial performance

Several studies have been performed concerning the financial optimization of the Corbioli House, comparing many combination of design options related to the envelope and the HVAC system [5-7]. The analysis have been carried out following the cost optimal methodology, introduced in [8] and defined in [9]. When compared with other systems, if combined with the opportune envelope design, the installation of the T-zen system resulted a cost-effective energy efficiency measure leading to the lowest global cost (including investment, replacement maintenance and operation energy cost) over a building lifecycle period of 30 years.■

References

Please see the complete list of references of the article in the html-version at www.rehva.eu
-> REHVA Journal

Certified ClimateHouse building in Mediterranean climate



CRISTINA BECCHIO
TEBE Research Group, DENERG,
Politecnico di Torino, Italy,
cristina.becchio@polito.it



GIANNI CARLO LA LOGGIA
Architetto La Loggia – Studio Architettura
Trino (VC), Italy
laloggia@libero.it



LARA ORLIETTI
TEBE Research Group, DENERG,
Politecnico di Torino, Italy,
lara.orlietti@studenti.polito.it

The need to plan and construct high performing buildings is higher than ever. This paper presents an example of low energy building in Mediterranean climate.

Keywords: low energy building, ClimateHouse certification, passive design strategies.

The construction of buildings and their operation contribute to a large proportion of total energy end-use worldwide; indeed, buildings account for 40% of the total energy consumption and for 36% of CO₂ emissions in the European Union. The sector is expanding, which is bound to increase its energy consumption. This trend raises some environmental issues such as the exhaustion of energy resources, global warming, the depletion of the ozone layer and climatic changes. The Commission's

Roadmap showed that greenhouse gas emissions in this sector could be reduced by around 90% by 2050 compared to 1990. The most immediate and cost-effective way of achieving this target is through a combination of cutting energy demand in buildings through increased energy efficiency and a wider deployment of renewable technologies. In order to reduce the growing energy expenditure, the European Directive imposes the adoption of measures to improve the energy efficiency in buildings. The recast of the Directive on the Energy Performance of Buildings defined all new buildings will be nearly zero-energy buildings by the end of 2020.

The case study

The case study hereby analysed, called *Eco Sil House*, consists of two similar single family houses realized in 2010, which rise up on an actually expanding flat area (**Figure 1, Figure 2**). Located in Trino, in north-west of



Figure 1. The *Eco Sil House*, south view.



Figure 2. Two new buildings located in Trino (VC).

Italy, in the Vercelli province, they were designed aiming to a healthy and sustainable environment, achieving the goals of a ClimateHouse A. The place in which they are located is characterized by a typical Mediterranean climate; not so cold winter and hot summer.

Each building, whose conditioned net surface is about 185 m², is characterized by two floors plus a non-habitable attic. The house has a rectangular plan with the living area and a technical system room on the ground floor; bedrooms are on the first floor.

The low energy needs and uses of the building are obtained thanks to the suitable combination of passive and active design strategies.

Passive design strategies

Passive solar design involves using the surrounding environment to ensure a comfortable indoor climate all year round, with minimal external purchased energy. The aim of exploiting passive solar design is that of achieving the performance target passively, through the usual methods of:

- positioning and orientation of the building for solar access and cooling breezes;
- super-insulation of the ceiling, walls, floor, windows, the main entrance and exit doors;
- careful placement of shading devices and wide openings for summertime;
- thermal mass for temperature smoothing.

The two buildings have been design according to the above principles. Indeed, each building, that has a rectangular plan, has been placed with the longer axis running east-west, in order to maximize solar heat gain. Living and sleeping rooms are placed toward the southern front; despite of that, on the northern side there are services and distribution spaces. The openings are present only in the above-mentioned facades; fronts toward East and West are fully blind. Rolling shutters have been installed in order to provide shading in summer periods.

Buildings are characterised by high insulation levels and compact volumes (**Figure 3**). An exterior thermal insulation has been adopted. Two different insulating materials have been used: the former is made of sintered polystyrene panels, the latter one of cellulose fibre. There is not any particular thermal reason to justify this choice, but it responds to a curiosity of the architect Gianni Carlo La Loggia of analysing contingent different behaviours and durability of materials in future. Both choices lead

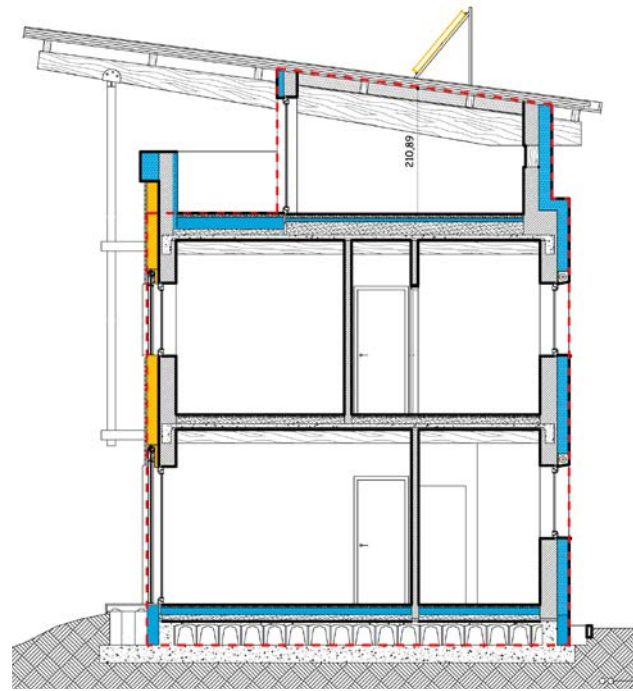

Figure 3. Vertical section of one of the buildings, with indication of heated volume and insulation layers.

the thermal transmittance to a very low value, ranging from 0.13 to 0.16 W/m²K.

Also the roof, which consists of a wooden structure, is characterized by a high insulation level, with wood-fibre insulation panels applied on the internal side. Thermal transmittance reaches a value of 0.18 W/m²K. All these solutions enable to totally eliminate every kind of thermal bridge; this is fundamental in achieving the goals of a ClimateHouse A.

A decisive role in achieving the energy performance goals is played by highly insulated windows. Buildings are provided with triple glazed windows, made of wood with aluminium-clad exterior, filled with Argon ($U_g = 0.7$ W/m²K) or Krypton ($U_g = 0.6$ W/m²K). In order to achieve the best energy performance of the windows, the openings have been wrapped by an insulating tape; in this way a low U value of 1.20 W/m²K is guaranteed.

The thermal masses, used for peak temperature smoothing typically of Mediterranean summer period, are concentrated in the external walls that consists of autoclaved aerated concrete blocks.

Another fundamental aspect it's represented by the air tightness of the envelope. Once completed the construction, the Blower Door test (**Figure 4**) has been performed in order to measure the air tightness of the buildings, which have passed the test, resulting within the limits required for ClimateHouse A classification ($n_{50,lim} = 1$ h⁻¹).



Figure 4. Blower Door test.

Thanks to the adopted passive design strategies, it's been possible to reduce energy demand; the energy need for space heating is low and equal to 23 kWh/m²y.

Active design strategies

Concerning active design strategies, the heating system is composed of a condensing boiler fuelled by natural gas, characterized by a modulated power of 5 kW up to 25 kW. The boiler provides space heating and domestic hot water too. The condensing boiler is coupled with four flat plate solar collectors, which cover a surface of 9.32 m² for each building, and with a hot water storage tank of 500 litres. The production of solar collectors satisfies about 96% of thermal needs.

The emission system is constituted by wall radiant panels, installed on the external wall, in **Figure 5**: this system guarantees energy savings up to 50% or more on heating costs in comparison with a traditional one.

It has been installed a 2.94 kWp photovoltaic system, characterized by monocrystalline silicon panels.

In order to reach a ClimateHouse A certification, the utilization of a mechanical ventilation system with heat recovery has been indispensable.



Figure 5. Installation of wall radiant panels.

Since the buildings are classified as ClimateHouse A, the savings in terms of energy consumptions for heating are about 80%, compared to traditional building consumptions, and CO₂ emissions are consequently reduced to 18 kg/m² year.

Monitoring data

The monitoring of the energy performance of the two buildings has been carried out for the first years through the evaluation of two data:

- indoor temperature, by means of thermostats, installed in every room;
- comfort perceived by each member of the families, in a range of five levels.

After the first year, buildings owners revealed to be really satisfied of the energy performance of their dwellings; the quality of living, achieved by a low energy construction, is part of everyday life and has a crucial effect on health. In the first year, they pay a bill equal to 480 € for space heating.

Monitoring data testified that coupling passive design strategies, characterized by substantial reduction of heat losses through the envelope and by maximization of solar gains, with active design strategies, consist of a suitable exploitation of renewable sources is a successful action. ■

References

1. Simpson C., Energy efficient renovation makes economic sense, Build Up, 2012.
2. www.agenziacasaclima.it.
3. *Prima CasaClima A in Provincia di Vercelli* in KlimaHaus – CasaClima, February 2011, p. 56.

Vaisala HVAC Instruments

The industry
benchmark
keeps getting
better

WIDE
PRODUCT
RANGE

UNIQUE CO₂
SENSOR WITH
BUILT-IN
REFERENCE

EASY PURCHASING
EASY INSTALLATION
EASY MAINTENANCE

STABLE AND
RELIABLE
HUMIDITY
SENSOR

QUICK AND
ACCURATE
DELIVERIES



90 series for high
performance HVAC



80 series for
standard HVAC

 Online Store
store.vaisala.com

www.vaisala.com/betterHVAC
sales@vaisala.com

VAISALA

Deep energy retrofit of vernacular housing



MANUELA ALMEIDA
Dep. of Civil Engineering
University of Minho, Portugal
malmeida@civil.uminho.pt



ANA RODRIGUES
Dep. of Civil Engineering
University of Minho, Portugal
anarocha32846@yahoo.co.uk



INÊS CABRAL
Ecooperfil, Portugal
inescabral@hotmail.com



MARCO FERREIRA
Dep. of Civil Engineering
University of Minho, Portugal
marcoferreira@civil.uminho.pt



ANDRÉ COELHO
Ecooperfil, Portugal
andre@ecoperfil.com



GONÇALO MACHADO
Ecooperfil, Portugal
goncalo@ecoperfil.com

An existing ruin of a vernacular house located in a rural area of Portugal is being renovated, aiming for architectural identity preservation and low environmental impact, to offer suitable comfort conditions for tourism exploitation. Calculated global energy consumption reduction is 94% of the calculated current energy use of the building

Keywords: Low-energy buildings; Vernacular architecture; Deep energy retrofit; Renewable energy systems; embodied energy.



Figure 1. Country house southeast and southwest facades.

Much has been done over the last decades regarding the improvement of energy performance in buildings and sustainable construction [1]. Nevertheless, for the case of existing buildings, the constraints are very relevant [2], not only for technical reasons, but also because of the risk of compromising significantly the identity of the building. In these cases, the technical and identity qualities should be carefully weighed with all the possible measures being evaluated from both perspectives.

Taking advantage of the recent growth in tourism activities in rural regions of the north of Portugal, the renovation potential of a traditional abandoned house has been analyzed to be used for sustainable tourism activities [3]. It aims at providing accommodation with sustainability principles, which means optimal use of environmental resources, respect and interaction with the host communities and viable, long-term economic operations providing fairly distributed socio-economic benefits to all stakeholders.

The house was originally built in 1940 with traditional vernacular principles (**Figure 1**), presenting uninsulated granite stone walls, wood structure floors and roof, ground floor in direct contact with soil (animal shelter) and single glazed windows with wooden frames. The external walls are massive but they are loosely arranged in some areas in need of structural reinforcement.

It is located in a small rural village in the hills of Peneda, at an altitude of 726 m above sea level and the local climate presents 2 770 heating degree days for a reference temperature of 20°C. The house is not served by any support system, including lighting, water supply and sewerage. There is no electricity or phone access and heating, during the time it was habited, was provided by a fireplace which was also used for cooking.

Its current state is almost of ruin, severely degraded in its wooden elements, lacking windows in some places and affected by rot and moisture. Inside temperatures closely follow exterior variations and chilled air drafts are frequent. Moisture deterioration is present in wood structures, both in floors and roof, and also through leakage and condensation on walls.

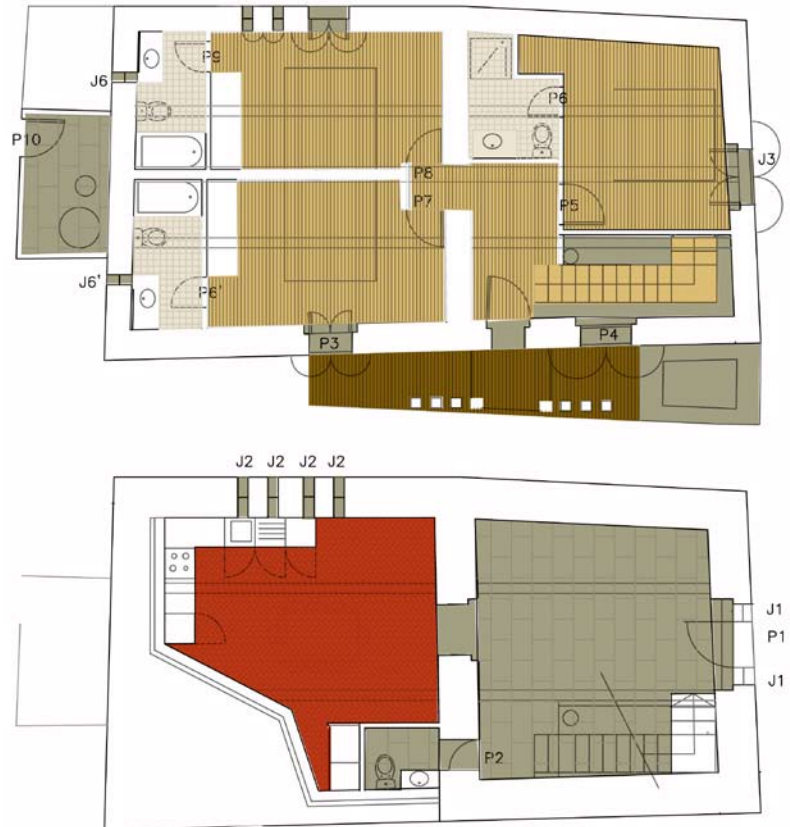

Figure 2. Upper (above) and lower (below) architecture plans of the retrofitted house.

Objective

The building has a strong architectural image, very much linked with the traditional life style and architecture of the region, but without suitable comfort conditions it will not attract visitors.

The global intention of the renovation is therefore to provide that comfort, at a minimum energy and resource expenditure, according to construction sustainability principles, while maintaining the building's identity and historical features (**Figure 2**). Understand the potential of retrofitting in vernacular construction may be an important contribution to promote other eco-tourism projects.

The renovation works are planned to be completed before the end of 2014.

Methods

In order to reduce the impacts of renovation measures, sustainable retrofitting actions have been considered. New construction was avoided to reduce the environmental impact and preserve the vernacular materials and principles, local based materials and others derived from wood wastes (MDF and OSB panels) were chosen due to

its low embodied energy, as well as concrete bricks (which are less energy intensive than ceramic bricks) and lime base mortar. In **Figure 3** the relevance of materials selection in reduction of embodied energy and environmental impacts is shown. To improve the energy performance of the building envelope, cork insulation boards have been used. In the building integrated technical systems priority was given to the use of renewable energy sources.

Energy renovation features

The main principles of the energy saving concept were limiting the heat losses during winter, use energy efficient heating equipment and take advantage of the sunlight to capture the thermal energy.

In order to prevent the energy losses during winter, different solutions were chosen to upgrade the building envelope, relevant not only to improve the energy performance but also to improve the thermal comfort.

The solution chosen for the walls was the creation of an interior closed air space and the placement of insulation cork boards (ICB) covered by light elements such as MDF boards over a wooden support. This solution allows maintaining the existing materials and avoids new construction while preserving the external architectural identity of the building.

For the roof, the solution was to create a wooden false ceiling, with structural oriented strand boards (OSB), placement of ICB insulation and a water tight covering.

For the windows, the solution consisted in replacing the existing ones by new ones with wooden frames and double glazing (4 + 6 mm) with a 16 mm air cavity between the glasses.

The building is equipped with mechanical systems for heating, air extraction in sanitary installations, air insufflation in main areas and centralized DHW generation. No mechanical system for cooling is provided due to the small area of glazing, low thermal transmission of exterior opaque elements (after rehabilitation) and the guarantee of a significant indoor thermal inertia. In this case, and given the mild summer climate of the region, natural ventilation and rational use of shutters shading are enough to achieve indoor summer comfort, both day and night.

The system for space heating and DHW is a 16 kW geothermal heat pump with its main features described in **Table 1**. Its primary circuit is placed in contact with the underground water level in open operating mode. It includes a weather compensated digital heat pump control unit RVS 61 with integrated cooling control function “passive cooling”.

Table 1. Geothermal heat pump main features.

Heating capacity	15.71 kW
Input	3.49 kW
COP	4.5
Flow temperature maximal	+55°C
Refrigerant	R407c
Compressor (count)	Copeland SCROLL (1)
Voltage	3 x 400 V / 50 Hz

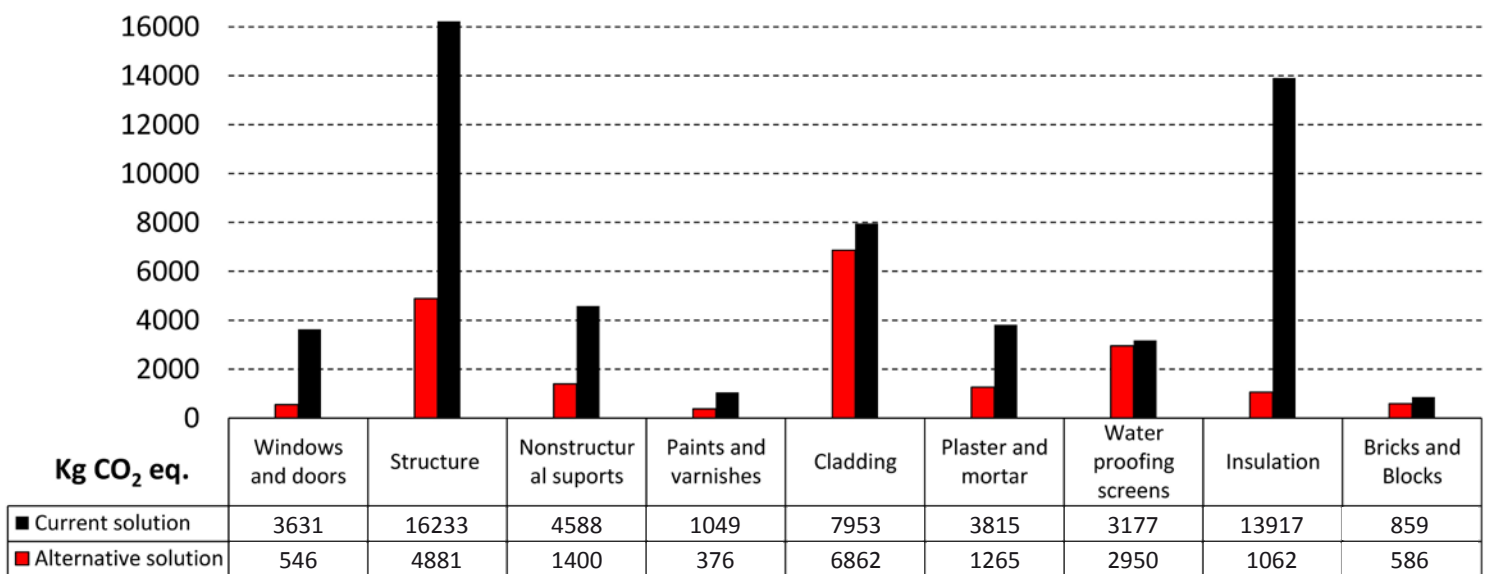

Figure 3. Embodied CO₂eq. amount for current (materials currently used in building renovation in Portugal) and alternative material selection (materials selected for this renovation project to reduce embodied energy and environmental impacts).

For heating, the emission is provided by radiators. For DHW, the main power supply is the thermal solar system with three solar panels connected in series with a total area of 6.78 m² and connected to a 300 litre electric storage tank that also receives the water heated by the geothermal heat pump. The solar panels are installed with a 35° inclination facing south and the annual expected contribution of solar thermal energy is 4.2 MWh/y which accounts for 69% of the total energy needs for DHW.

Mechanical ventilation with a heat recover box with 91% efficiency, guarantees fresh air supply and exhaustion to all spaces, with insufflation provided through the rooms, living room and kitchen and extraction through bathrooms and entrance. The totality of the extracted air is guided to the heat recover box, with its main features described in **Table 2**.

It is a compact unit, vertical, leaning on the pavement. Heat exchange is accomplished through a counterflow plates recuperator, wherein there is no contact with the insufflated air against extracted air. Given the configuration of the HVAC system design, the equipment will not be provided with battery for heat or cold transmission, carrying only ventilation and heat recovery above described. It will bypass the heat exchange to enable free-cooling, and will have integrated control and condensate tray. Ventilation will be performed using filtering with F5 quality for insufflation and extraction.

Lighting will be assured by fluorescent and LED based lamps.

In brief, the adopted energy renovation features are the following:

Technologies:

- Interior insulation cork board
- Wooden framed double glass windows
- Mechanical ventilation with heat recovery
- Geothermal heat pump
- Thermal solar panels (for DHW)

Systems:

- Heating and DHW: 16 kW geothermal heat pump
- Cooling: Natural ventilation and wooden shutters on windows
- Ventilation: Heat recovery box with 91% efficiency. Fresh air supply and exhaustion of all spaces
- Lighting: Up to date fluorescent and LED based lighting

Renewable Energy Systems:

- Thermal solar panels for DHW preparation

Table 2. Heat recover box main features.

Model	Power Box 95 V700 / France Air
Air insufflation	620 m ³ /h; 180 Pa; 355 W
Air extraction	530 m ³ /h; 250 Pa; 355 W
Efficiency	Up to 91%

Table 3. Thermal characterization of the building before and after the renovation.

Element	Area (m ²)	U-value before renovation (W/m ² .°C)	U-value after renovation (W/m ² .°C)
Exterior Walls	85.0	1.82	0.45 (average)
Ground floor	54.0	Direct contact with soil	0.50 (average)
Roof	80.4	4.55	0.23
Doors	3.0	2.70	0.81
Windows	7.8	4.60	2.05

Regarding the thermal quality of the envelope, comparing the U-values proposed for the renovation (**Table 3**) with the reference values from the recently published building thermal regulation (D.L. n.º 118/2013 from 20th of August), only for the case of the external walls the proposed values are above the reference (0.45 for the case study and 0.35 in regulation for new buildings), with all the other building elements under the reference and well under the maximum allowed values.

Impact of the retrofitting

With the chosen renovation solution there are significant comfort improvements. Regarding the energy performance of the building, only the calculated values of the energy needs are possible to present once the original building didn't have non-renewable energy consumption and wasn't able to provide comparable thermal comfort conditions. Therefore, the calculated heating needs are reduced in 74%, the cooling needs in 14% and the DHW needs in approximately 95%. **Table 4** summarizes the impact of the retrofitting measures on the heating, cooling and DHW needs including the contribution of the solar thermal panels. The table also presents the energy label.

In Portugal, the energy certification scheme ranks the energy performance of buildings from level G to level A+, where G is the less efficient. The A+ label means that the calculated primary energy needs are less than 25% of the maximum allowed value.

Overall improvements

The renovation intervention will allow providing the necessary comfort for tourism accommodations in all the seasons of the year, providing an indoor climate absence of drafts, condensation phenomena and assuring the control of the users over the indoor temperatures.

On a broader level, an intervention driven with these sustainable construction principles is always good for the local economy. Tourists enjoying nature can be housed enjoying comfortable conditions with minimum environmental impact, leading to further attraction of more tourists with interest in eco-tourism and as consequence it helps to develop the local economy. Furthermore, these broader economic benefits may also result as a trigger for more retrofitting of local vernacular buildings.

Barriers

The implementation of energy renovation projects in the building sector is not just a technical matter. It involves the economical context, lack or misleading information to the decision maker and sometimes ownership issues with different persons paying the investment and saving from the better energy performance (split incentives).

Energy renovation projects often run into barriers that may hold up the project. It is then necessary that owners, technical consultants and other entities involved in the process find solutions to overcome these barriers.

The main barriers in this case were related with the bureaucracy for obtaining the building permit, finding funding sources for the renovation works and some miss information between owners and technical consultants.

The bureaucracy for obtaining the construction permit from the municipality and national tourism entities is still a time consuming process that causes delays and doubts for project planning.

The details of a deep energy retrofit usually carry extra costs, which are not always well understood by the owners. Strong commitment between the owners and technical consultants is crucial for finding the best possible solution within an affordable budget, considering not only the investment costs but taking into account a life cycle costs perspective.

Conclusions

The offer of comfort conditions for tourism exploitation, with architectural preservation and low environmental impact, were the main driving forces for the development of this project.

Table 4. Summary of the energy renovation impact.

		Before renovation	After renovation
Energy needs (kWh/m ² .y)	Heating	477.9	123.8
	Cooling	12.1	10.4
	DHW	54.8	3.0
	Reduction	-	75%
Energy label		F	A+
Primary energy use*		543.1	34.35
Primary energy use reduction		-	94%

* Calculated primary energy use considering the use of most common electrical building integrated systems, for heating, cooling and DHW, in Portugal.

The global energy consumption reduction reaches 94% when compared to the hypothetical use of the house, on its current state. Even for building renovation, the materials selection might have significant relevance for reducing embodied energy and environmental impacts.

Although the definition for nearly zero energy buildings is not completely established in Portugal, current case study shows that it is possible, even for existing buildings located in the coldest areas of the country, and taking into account the preservation of architectural values, to renovate towards very low energy use using existing technologies, with significant emphasis to the HVAC system solutions. ■

References

- [1] Harvey D., 2013. Recent Advances in Sustainable Buildings: Review of the Energy and Cost Performance of the State-of-the-Art Best Practices from Around the World, Annual Review of Environment and Resources, Vol. 38: 281-309.
- [2] Jakob, M., 2007. The drivers of and barriers to energy efficiency in renovation decisions of single-family home-owners, CEPE Working Paper n°56.
- [3] Cabral I., Coelho A., Machado G., 2013. Assessing energetic self-sufficiency and low environmental impact in Pontes, Portugal, Proceedings of CIAV 2013, 7th ATP Versus, Vila Nova de Cerveira, Portugal, 16-20 October, 593-598).



Lindab Pascal

Simplified VAV solution with full potential...

Lindab is now launching the next generation of VAV system with the purpose of simplifying and optimizing all phases of the building construction from design to operation. This solution saves you for unnecessary energy use, regulation equipment in the ducts and a complicated installation. Lindab Pascal, the most simplified solution on the market with all you need for an optimized VAV system.

Lindab – We simplify construction...



The challenge of designing and building nZEBs:

a single-family house in Italy



STEFANO PAOLO CORGNATI

Vice-president of REHVA,
TEBE Research Group, DENERG,
Politecnico di Torino, Italy,
stefano.corgnati@polito.it



CECILIA GUALA

TEBE Research Group, DENERG,
Politecnico di Torino, Italy,
cecilia.guala@polito.it



MARCO LUCIANO

GOODFOR architecture
and design, Torino, Italy
marco.luciano@goodfor.it

CorTau House is a single-family house, realized by renovating a “curmà”, a traditional rural building, located in Livorno Ferraris, in the Northern Italian region of Piedmont. The construction of the building, started in March 2014, is still in progress but this nZEB already represents a good example for the replicability and implementation of a high-performing house model at the regional and national levels. The project and realization of the building are described from the project owner/building system designer, S.P. Corgnati, and from the architectural designer, M. Luciano.

CECILIA GUALA



Figure 1. The designed *CorTau House*, south front.

In keeping with the European definition of nZEB [1], the *CorTau House* represents an Italian significant design experience in which the architectural quality in renovating a traditional rural building is combined with the use of high-performing energy solutions. **The nZEB realization challenge is presented here in the form of interview with the designers.**

Keywords: nZEB, energy efficiency, cost control, traditional rural building, building system, architectural quality.

A first question to the project owner: what led you to realize a nearly Zero-Energy Building?

S.P.C.: Mainly the possibility to ensure the energy independence of the building from fossil energy sources: the *CorTau House* (**Figure 1**) is indeed “all electric” and meets the energy demand through self-generation of electricity from a solar PV system. Moreover the project pursues the dual objective of combining the nZEB requirements [2][3] with architectural quality principles and with the renovation of a traditional rural building widely diffuse in Piedmont.

Which are the main benefits deriving from this kind of building?

S.P.C.: The main advantages, in keeping with the nZEB philosophy, are surely a considerable reduction of the energy required for conditioning the house and the meeting of energy needs through the use of on-site renewable sources, including the sun and the heat extracted from groundwater.

Which elements have played a decisive role in designing and realizing the building? How influential have been the context, the previous existence of a traditional building and the current energy efficiency legislation?

M.L.: The traditional rural framework has surely influenced the project, whose aim is to preserve and to enhance the distinctive features of the building (Figure 2). The roof covering in tiles and the wooden roof structures have been maintained, so as the brick pillars. The design team also had the good fortune to reinterpret an ancient intuitive know-how in a scientific way, according to bioclimatic architectural principles: the existing building indeed, fully opened on the south side, presented a closed façade on the north side (Figure 3): the project has been adapted to this simple existing structure, optimally suited to achieve excellent energy performances.

Which architectural, technological and structural solutions have been adopted?

M.L.: Our architecture study is used to work with reinforced concrete septa, which have the dual function of

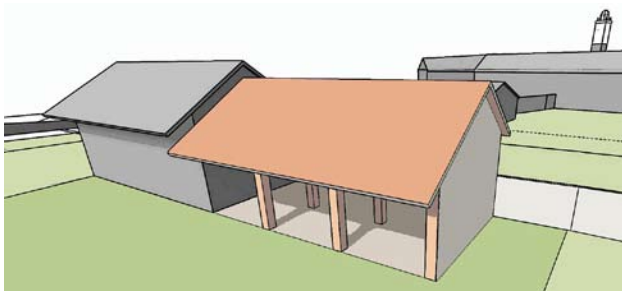

Figure 3. Volumetric representation of the pre-existing rural building, south front.



Figure 2. Picture of the pre-existing rural building, south-east side.

acting as structural elements and including the building systems. Moreover, massive structures are adopted in order to get the most out of the thermal inertia of the building envelope, considering the temperate climate of the context. The result is a building characterized by parallel axes that incorporate the building systems in a north-south direction and by horizontal surfaces enclosing the living space: there is a symbiosis between the building structure/envelope and the technological aspects characterizing the living space. With regard to the building envelope, there is a clear separation between the highly insulated opaque components, characterized by external insulation, and the transparent surfaces, in order to minimize the creation of thermal bridges.

Apart from building envelope measures, which energy efficiency strategies have been adopted with regard to the building system?

S.P.C.: A controlled mechanical ventilation system with heat recovery and dehumidifier is combined with radiant floors for heating and cooling; a geothermal heat pump provides the production of cold and hot water for the radiant panels and Domestic Hot Water (DHW). All the electricity needs of the building for lighting, cooling and interior equipment are covered from a 7 kWp grid-connected photovoltaic system installed in the roof.

Acoustic solutions have been considered too?

S.P.C.: In the *CorTau House* the soundscape design concerns not only the building itself but also the garden. The main acoustic protection of the house is indeed provided by tree planting and hedges, which have the additional functions of solar control and privacy screening. With refer to the building, reinforced concrete septa placed between living and sleeping areas provide the acoustic insulation of these two macro-areas of the house.

Among the adopted design measures, which ones revealed to be priority for the nZEB realization? On the contrary, which solutions have been ruled out and why?

S.P.C.: The project experience has highlighted the importance of individuating the correct relationship between opaque and transparent surfaces in relation to different room exposures, in order to correctly design external sun screens and to control the solar radiation. The optimization of the building energy performance is based on passive energy solutions: since the first concept, the architectural design and the energy-saving project have been complementary and decisive in the evolution of the project. The project originally involved an articulated system of reinforced concrete septa and slabs: this solution has been ruled out in the final project. The structure has been simplified, giving way to clearer separation between opaque and transparent surfaces, in order to avoid thermal bridges and to control the construction costs due to concrete paving.

A fundamental strategy towards nZEBs is an integrated design methodology: how did the architectural project evolve in order to achieve the goals of energy efficiency and cost optimality?

M.L.: The architectural design work has been carried out in parallel with the building system design from the preliminary phases: the creative role of the architectural designer has been driven by nZEB energy goals, together with the property owner's request of cost control, with reference both to the investment costs and to the future running and maintenance costs. As said before, in a



Figure 4. The first concept of the house, south front.

previous stage of the project (**Figure 4**), the house was characterized by an articulated structure with stepped levels, including a basement used as a garage. In order to control the costs, the project has been modified, proposing in the final version a one-storey residential unit with reduced net floor area and volume (**Figure 5** and **Figure 6**). The interior spaces and structures of the house have thus been optimized, ensuring reduced energy losses and, consequently, lower energy needs for heating and cooling in future. Moreover, costs for excavations and costs due to the realization of a second staircase and to the installation of a distribution manifold for the first floor have been avoided.

What about the building estimated energy performance? How have the consumptions been calculated?

S.P.C.: In keeping with the definition of nZEB [1], the energy consumption of the house is nearly zero: the low energy demand is covered through self-generation of electricity from PV system. The energy performance of the building has been calculated in the preliminary phases of the project through calculation software based on the European standards. At a later stage the energy consumptions of the building have been calculated using dynamic energy simulation tools for comparing the estimated final energy demand profiles and the energy production ones.

The quality of the final work is surely prime in order to achieve the prefixed targets; did you encounter any problem in finding materials and trained manpower?

M.L.: No, I didn't encounter relevant problems thanks to a great synergy with a highly qualified construction company. The manpower and the technicians on site revealed to be trained in the construction of high quality buildings: the attention given to building details is a fundamental aspect for the achievement of the result.

How much does the realization of a nZEB cost with respect to a "traditional" building? How long is the estimated payback period of the investment extra-costs?

S.P.C.: The costs are clearly related to the adopted solutions: for example in this case the architectural and structural use of massive concrete structures has affected the construction costs. The investment extra-costs are about 30% higher than the costs to be bared for the realization of traditional buildings, considering standard finishes. This percentage of extra-costs is however more elevated than for other nZEBs because of a decisive boost to experimentation with regard to the building system, which could be simplified. In relation to the investment extra-costs, the payback period has been estimated of less than a decade, a reasonable period considering that the investment is made in a primary residential property.

Are tax deductions or other financial subsidies granted for the realization of a nZEB at the national or regional level? In your opinion are they suitable?

S.P.C.: In Italy energy retrofits are strongly subsidized in terms of tax deductions for interventions of building renovation and energy efficiency. In 2014 and 2015 for refurbishment works on real estate property it is possible to benefit from a tax deduction of 50%, for building renovation, and of 65%, for energy retrofit actions, over ten years, on a maximum spending limit respectively of 96,000 € and 100,000 € per real estate unit. Financial subsidies are nowadays fundamental in order to incentivize energy efficiency actions.

This building can be taken as a model for the future realization of new nZEBs and for their distribution at the national and regional levels. Which design and construction "rules" followed for this case study could be replicated for other ZEBs?

S.P.C.: The "curmà" is a typology of widely diffuse building in the Northern Italian rural areas: the *CorTau House* shows a new possible way to interpret its renovation and re-functioning. A replicable "rule" is surely the idea of preserving the existing structure and adding to

it a new building organism characterized by innovative energetic and architectural performances.

M.L.: I agree with the above but I would also like to underline that in my opinion there is not a correct or wrong model for designing a building: the building quality is the result of a correct balance between several elements, different for each project. The *CorTau House* is an example of nZEB located in a rural Po plain scenario; a good model of nZEB surely fits into the context and is designed on the basis of the specific needs, climatic conditions and traditions of the place in which it is realized.

Is there any other theme you would like to highlight?

S.P.C.: In our climatic conditions the nZEB design challenge can be summarized in two basic concepts: the careful design of the building considering both the winter conditions and the summer ones and the control of humidity – fundamental for a building surrounded by rice fields. The compensation between the building behavior during winter and summer seasons represents the basis of the reasoning intended to emphasize the passive design.

M.L.: I think that this design experience also highlights another issue: this house represents a good project in relation to the urban space, nowadays degraded in Italy. In this sense the *CorTau House* can be assumed as a model for sensitive zones, in order to demonstrate that also controlling costs high results in terms of quality of life are achievable. ■

References

- [1] Directive 2010/31/EU of the European Parliament and the Council of 19 May 2010 on the energy performance of buildings (recast).
- [2] REHVA nZEB technical definition and system boundaries for nearly zero energy buildings, 2013 revision for uniformed national implementation of EPBD recast prepared in cooperation with European standardization organization CEN. REHVA, Federation of European Heating, Ventilation and Air-Conditioning Associations, Report No 4, REHVA 2013.
- [3] ECOFYS, Towards nearly zero-energy buildings - Definition of common principles under the EPBD. Final report, February 2013.



Innovative Products For Sustainable Environment

Choose Friterm **Class A**
Products in Your Applications



Unit Cooler



Horseshoe
Heat Pipe



High efficiency heat
exchanger for run around
loop heat recovery systems



V Type Dry Cooler



Horizontal Type
Air Cooled Condenser

CO₂ (R744)
Unit Cooler and
Gas Cooler Units



 **SME SUSTAINABLE
ENVIRONMENT FRIENDLY PRODUCT
FIRST PRIZE 2010**

FRITERM[®]
since 1979

Head office / Factory:
Istanbul Deri Organize Sanayi Bölgesi Dilek Sokak No:10
X-11 Özel Parsel Tuzla 34957 İstanbul / TURKEY
Tel: +90 216 394 12 82 (pbx) Fax: +90 216 394 12 87
info@friterm.com
www.friterm.com



Energy efficiency and HVAC systems in existing and historical buildings

The topic of refurbishing historical buildings is one of the energy challenges all over Europe. In this scenario, AiCARR developed a proposal for a conscious approach in energy retrofitting.

Keywords: historical buildings, energy efficiency, HVAC systems.

The challenge of refurbishing existing and historical buildings

Refurbishment of existing and historical buildings is a priority in many European Countries. In 2014 AiCARR published guidelines intended for both design engineers and superintendencies. Due to the need of developing a harmonized approach focusing on historical buildings, AiCARR developed a specific guidebook entitled “*Energy efficiency in historic buildings*” [1] to support technicians in carrying out energy retrofit actions in historical buildings. The guidelines provide the design engineers with a tool for the energy audit of the historic building and offer a framework for the design of possible energy upgrades, which are conceptually similar to those provided for non-protected buildings, but appropriately tailored to the needs and peculiarities of the cultural heritage. On the other hand, the guidelines provide the institutions responsible for protecting the building, the possibility to objectively decide on the level of energy efficiency achieved as a result of the rehabilitation in accordance with the conservation criteria.

Whenever an intervention is required to a protected property or nevertheless to a property of cultural value, it should be considered that the work to be carried out falls within the scope of restoration and the priority objectives are *to preserve and bring these assets in line with the future* in the best possible condition [2].



LIVIO DE SANTOLI
Università degli Studi di
Roma “La Sapienza”,
President of AiCARR,
livio.desantoli@uniroma1.it



FRANCESCA R. D'AMBROSIO
ALFANO
Università degli Studi di Salerno,
AiCARR,
fdambrosio@unisa.it

Even the energy efficiency measures should pursue the above stated purposes, which means considering energy efficiency as a tool for protecting - rather than a process of upgrading that conflicts with the conservation requirements. It follows that the design choices should be made by consulting with the conservation experts. In this regard, the following criteria set out in the Venice Charter for Conservation and Restoration [3] are of invaluable help: compatibility, minimum intervention, reversibility, distinguishability, expressive authenticity, durability and respect of the original fabric.



Figure 1. Integrating historical buildings with new innovative solutions (from: 49th AiCARR International Conference, Historical and existing buildings: designing the retrofit. An overview from energy performances to indoor air quality. Rome 2014).

In historical buildings refurbishment is very important to respect the relationship between restoration and installations that today is still little explored from a theoretical point of view, and definitely less, for example, than the corresponding relationship between restoration and the need for full accessibility - or even between restoration and structural consolidation works.

Even in this case, as for the structural consolidation, it is necessary to radically rethink the concept, which is reflected in a new methodological approach, an example of which is suggested in these guidelines.

If we start from the same experience that some years ago brought about a debate on the problems related to the historical-critical process, and to the scientific-technical process for consolidation restoration projects, which recognized the need of a rigorous method of unity, this same method should be proposed for the energy efficiency of a cultural asset.

In the restoration-systems relation we still see a gap in the rules and regulations. Notwithstanding this gap, the need to include systems in the restoration concept and the three-point criteria (minimum intervention, reversibility and compatibility) is well established.

To this regard, AiCARR specifically proposes that the concept of “improvement” replaces the concept of “adaptation” in the current standards and requirements also with regard to safety and comfort, elaborated along the lines of “integrated conservation” [4].

Proposals to *improve* the energy compliance of a historic building (or, even, of a cultural landscape) can be made by taking appropriate measures that are well-balanced for a suitable architectural or landscape integration. This means that you will often have to settle for a partial architectural integration, rather than a total integration, as would be desirable for new buildings. The required level of integration must be such that the interventions proposed do not upset the asset itself, which is the case when “adapting” it to the current standards and requirements, as if it were a new building.

The proposed methodology should be based on an interdisciplinary approach, the main steps of which are clearly set out in the guidelines. These steps include: following the general principles and concepts; an analysis of the plant engineering systems; measuring the environmental quality and determining the risks to historical buildings (including identification of the proposed intervention as it relates to the building and the system).

AiCARR procedure to improve the energy efficiency of historic buildings

Figure 2 shows the flow chart of the proposal made by AiCARR regarding the best improvement procedure on how to improve energy efficiency.

The procedure involves some preliminary actions aimed at a correct energy audit, downstream of which the actual energy performance index must be calculated.

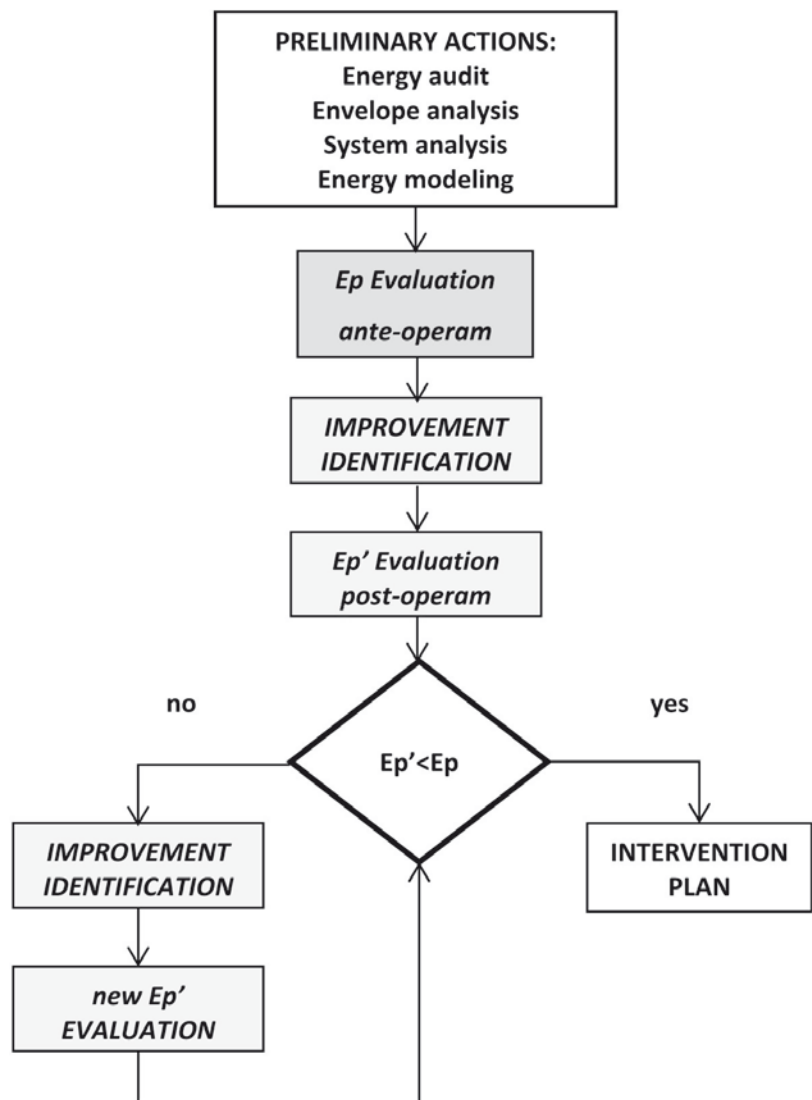

Figure 2. Flow diagram of the energy efficiency improvement procedure.

The energy audit should also be used to evaluate the possible improvement actions, which must be calculated on the basis of the post-construction energy performance index. Obviously, if the improvement has led to concrete results it is possible to proceed; otherwise the process should be repeated by analyzing the audit levels more thoroughly.

HVAC Systems in existing and historical buildings

From the HVAC systems engineering point of view, historic buildings that have not been affected by recent maintenance work, whether ordinary, extraordinary or preventive, are generally equipped with obsolete equipment. HVAC systems, in principle, could be replaced, but can actually be evidence of the past and as such have a historical interest; therefore they should be carefully recovered, valued and, if possible, made useable. Consider the little-known, but extremely interesting Italian San Leucio monumental complex (**Figure 3**), belonging to the World Heritage List, which includes the so-called “Bathroom of Queen Mary Caroline”, which can be traced to the ancient Roman baths.

It goes without saying that an assessment to possibly reutilize HVAC systems that have a historical value involves problems of protection and often enhancement. It is an interdisciplinary process that the designer has to manage in terms of thermal engineering and also requires the typical skills of Cultural Heritage experts. An analysis of historical works to assess the possibilities

for protection, enhancement and fruition is therefore an integrated process in which the designer plays a particularly important role.

It is clear that an improvement in the energy performance of a building as a whole must include work to the installation, unless particular historic, architectural or functional restrictions make it inadvisable or impossible to carry out.

Regarding the performance of a building envelope, measures are generally taken on the thermal insulation of opaque and transparent, horizontal and vertical components by applying materials and/or technologies that increase the thermal resistance and reduce the internal/external thermal exchange. Thermal insulation may not always be practicable in a historic building whose facades and/or interior elements are of a historical or architectural value, whereas such work can be done to an existing building, which in itself has no historical value but holds a cultural heritage; for example, a newly built museum.

A tool to assess landscape integration

To improve the energy efficiency of historic buildings can have, more often than not, an impact on the landscape due, for example, to interventions which might interfere with the characters of historicity and antiquity of the building or to plant engineering installations that may not be synergistic with the landscape, seen aside from the building.



Figure 3. San Leucio complex: an example of renovation (from ©Google Earth 2014).

In these cases, special attention has to be paid to landscape integration, which must be assessed at different scales of intervention for each typological element on the basis of the following criteria:

- Technology, intended as the degree of replacement of the building and system components;
- Landscape, morphological, form and colour perception.

As a first assessment of the overall degree of integration of the project, a sheet such as the one shown in **Table 1** can be used to be filled-in by the designer of the intervention on the basis of the documents produced, as illustrated below, and which is assessed by the Cultural Heritage national Offices. This sheet is a summary that will then be compared with the results of the energy

assessment and is also useful to for an initial screening on the acceptability of the project, in the sense that interventions, which are not characterized by at least a partial degree of integration, cannot be submitted.

HVAC system maintenance

The new Italian Cultural Heritage Code [5] for the first time includes the concept of maintenance in the Italian national legislation on the protection of architectural and landscape heritage. This topic is crucial for historical buildings. Maintenance to the installed systems must therefore be provided during the design phase, included in the general maintenance plan and must be consistent with the requirements specified for proper conservation of the entire building over time. Choosing suitable positions according to the conservative requirements is not sufficient: it is also necessary to provide for regular accessibility to the systems without causing any damage to the

Table 1. Preliminary assessment sheet for integration in the landscape.

Scale	Typological element		Integration level			
			Technological	Scenic		
				Formal	Morphological	Chromatic
Microscale Architecture Building- place- construction	Cover	Opaque surfaces				
		Transparent surfaces				
	Façade	Opaque surfaces				
		Transparent surfaces				
	HVAC systems					
Mesoscale Square-block- surrounding	Cover					
	Façade					
	Installations					
Macroscale territory	Cover					
	Façade					
	HVAC systems					

Integration level: ○ = partial; ● = total

existing building. Furthermore, care must be taken to control the physical and chemical characteristics as well as the behaviour of new materials over time to prevent the occurrence of events that are incompatible with the proper life of the historic building. The overall energy efficiency of a building also depends on the level of maintenance performed, obviously with special regard to the management and maintenance of technical installations.

In Italy HVAC systems must be designed, constructed and installed so that cleaning of all internal surfaces and components can be performed in accordance with the provisions of the UNI 12097:2007 standard and national guidelines. This is a prerequisite to ensure that these systems can be operated and maintained in such a way that hygiene requirements are complied with at all times. Regular technical inspections and maintenance servicing as well as frequent health checks must be carried out by specially appointed qualified personnel. Therefore, a register for the documents related to ordinary and extraordinary maintenance to water systems and air conditioning systems should be adopted.

Historic buildings and standard evolution related to energy efficiency: the AiCARR proposal

In the case of historic buildings, it will be necessary to interpret the possibility of unifying and simplifying all the Italian current laws and decrees related to energy performance of buildings in a more incisive manner. This topic is currently being discussed by the operators of the heating sector, who are often in difficulty with reference to the interpretation of the scope of the legislative body on energy efficiency in buildings.

AiCARR believes that it is necessary to clarify the subject of energy saving in the building industry in general, and with special reference to historic buildings, establishing a few rules that are clear and that cannot be interpreted at will. To this end, AiCARR believes that the following would be essential:

- introducing a performance index that takes into account only non-renewable primary energy;
- defining the energy performance of a building only through the primary energy requirements;
- providing a definition of energy from renewable sources;
- defining the nZEB (nearly Zero Energy Building) univocally, i.e. a building characterized by a low demand for non-renewable primary energy;
- defining the assessment method on exported energy, for example by referring to the territorial context.

According to AiCARR, these rules should only relate to matters regarding the energy performance of the building, during the design or upgrading phase, not to checks and inspections of use and maintenance. In particular, aspects related to the minimum performance of the building as a whole should be separated from those related to energy certification, so as to eliminate the misunderstanding that the design activity is aimed only at obtaining the energy performance certificate.

With regard to the minimum performance, AiCARR believes that it is necessary to identify the minimum requirements which can be easily verified by the municipality or concerned institutions, without necessarily having to perform a complete calculation of the energy performance. For instance, the following criteria could be taken into account:

- transmittance: indicate the value of the transmittance of the walls responsible for 60% of the total dispersion;
- subsystem efficiency: provide a minimum reference value;
- production efficiency: indicate a minimum value of the nominal efficiency and think of a way to limit oversizing.

Evidently, appropriate adjustments for historical buildings should be provided and regulated. ■

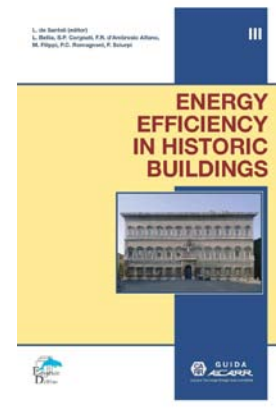
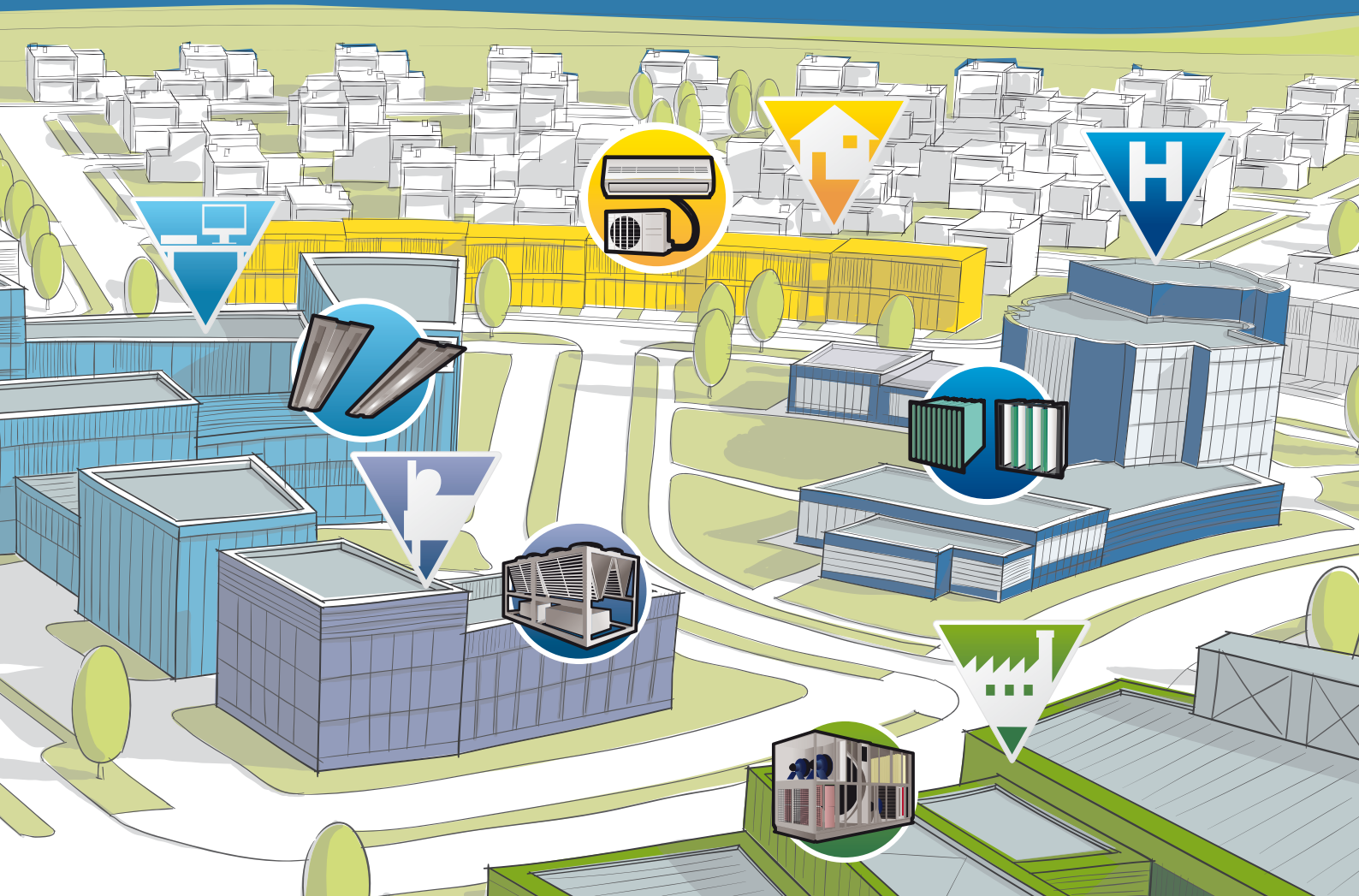

Figure 4. The guidebook developed by AiCARR.

References

- [1] L. de Santoli et al., 2014. *Energy efficiency in historic buildings*. AiCARR Guidebook. Milano: Editoriale Delfino;
- [2] Italian Ministry of Education, 1972. *Charter for conservation and restoration*;
- [3] ICOMOS, 1964. *International Charter for the Conservation and Restoration of Monuments and Sites* (Venice Charter);
- [4] Congress on the European Architectural Heritage, 1975. *The Declaration of Amsterdam*.
- [5] President of the Republic of Italy, 2004. *Italian Cultural Heritage Code*.

LOOKING FOR **HVAC-R PRODUCTS** FOR YOUR BUILDING ?



WE CONTRIBUTE TO
HIGHER ENERGY EFFICIENT PROJECTS

SELECT EUROVENT CERTIFIED PRODUCTS AND CHECK PERFORMANCE ON LINE

The Eurovent Certification label is a guarantee that the energy level indicated is based on certified performances. Eurovent Certification certifies the thermal and acoustic performance of air conditioning, ventilation, heating and refrigeration equipment tested at independent ISO 17025 accredited laboratories. The certification protocol includes sampling of the units to be tested, annual test campaigns, downgrading of indicated performance levels in the event of test failure and subsequent publication of data.

www.eurovent-certification.com



Comfort cooling and solar power – a perfect match?



ELSA FAHLÉN
PhD. Energy systems
NCC Construction Sweden AB
elsa.fahlen@ncc.se



HENRIK OLSSON
M.Sc. Eng.
NCC Construction Sweden AB
henrik.t.olsson@ncc.se



NIKLAS CHRISTENSSON
Energy Controller
Eksta Bostads AB
niklas@eksta.se

In buildings where there is a demand for comfort cooling, electricity-driven compression chillers combined with photovoltaics may be an interesting solution to achieve net zero in energy use for cooling thanks to the potential simultaneity in demand and generation of electricity during summer. Using the first passive house-certified retirement home in Sweden as a case, this paper presents and evaluates how well the load demand and the solar power generation coincide hour by hour.

Keywords: solar power, photovoltaic, comfort cooling, load matching, passive house, net zero energy building, low energy building, retirement home.

The EU Directive 2010/31/EU on the energy performance of buildings implies that in the next few years all new buildings or existing buildings that are subject to major renovation have to be so called net zero energy buildings (December 31 2018 for public buildings and December 31 2020 for other buildings) [1]. Apart from having a very low energy use, a high share of the energy used in these buildings should come from renewable energy sources, including renewable energy sources on site or nearby.

A lot of effort has been made to reduce the use of energy in Swedish buildings, especially the energy used for heating. However, when the heat demand is lowered due to improved insulation, the need for cooling increases. Apart from the cooling demand due to climatic conditions, growing population and higher living standards, increased numbers of technical appli-

ances such as lighting, printers and computers also increase the need for cooling. In warmer countries, the peaks in the power demand are partly due to the use of electricity-driven cooling facilities [2]. Within the European countries, the growing number of cooling facilities increases the already strong daily variations in electricity demand and thereby also the need for peak load power generation [3] which is associated with high operating costs and CO₂ emissions.

During summer, power demand for comfort cooling and solar power generation coincide well since both are related to the solar radiation. Therefore, electricity-driven compression chillers coupled with photovoltaics (PVs) may be an interesting solution to achieve net zero in energy use for comfort cooling. However, even if the electricity used for cooling may easily be covered by solar power from a PV plant on a monthly basis, is there a perfect match also on an hourly basis?

Objective

This paper presents and evaluates how well the load demand and the solar power generation coincide hour by hour and how this affects the annual coverage rate and the amount of surplus power generated. The study is a case study of electricity-driven compression chillers and PVs located at the retirement home in the passive house area Vallda Heberg, see the upper left corner in **Figure 1**.

Vallda Heberg passive house residential area

In the residential area Vallda Heberg, in the municipality of Kungsbacka in Sweden, all buildings are designed, built and certified according to the Swedish passive house standard Feby [5]. The municipal housing company, Eksta Bostads AB, and the construction company, NCC Construction Sweden AB, have built the passive house area which consists of single family houses, apartment blocks, terrace houses, a retirement home and commercial buildings, see **Figure 1**.

These highly insulated buildings with heat recovery have a very small energy demand for space heating. The small amount of energy needed for space heating and domestic hot water is supplied by 100% renewable energy generated on site and which is distributed in a local district-heating network. The goal is that as much as 40% of the annual energy use for domestic hot water and for space heating will come from solar thermal collectors. The rest of the heat needed is supplied by a local wood pellet boiler.

The first retirement home certified as passive house in Sweden

The retirement home in Vallda Heberg is the first passive house certified retirement home in Sweden. It has a net floor area (A_{temp}) of 7,280 m² and consists of 64 small apartments divided into six departments on three floors. The retirement home also has social areas and activity rooms for the residents, a kitchen and a restaurant and office for the employees.

Residents in retirement homes are more sensitive to higher temperatures during the summer season. In order to reduce problems with over-temperatures during summer in the retirement home in Vallda Heberg, solar shading has been mounted above the windows. Still there is a small demand for comfort cooling during the summer and, therefore, a cooling system has been installed.

In order to cover a part of the electricity used in the retirement home, 545 m² of photovoltaics have been installed on the roof, see **Figure 2**. The goal is that at



Figure 1. Passive house residential area Vallda Heberg during construction [4].



Figure 2. Photovoltaics installed on the roof of the retirement home in the passive house area Vallda Heberg [6].

least 40% of the total building service electricity and 100% of the electricity used for comfort cooling, will be met by solar power on an annual basis.

Technical description of the heating, cooling and power system

The calculated annual specific energy use is 50 kWh/m² A_{temp} . This includes energy use for space heating and domestic hot water, electricity use for lighting, pumps, fans and elevators and solar power generated (as a negative energy use). In the simulation of the building energy performance, the temperature is allowed to vary between 22°C and 25°C.

The performance of the PVs and the compression chillers installed are described in **Table 1**.

Measurements and limitations

The solar power generation has been measured since August 2013. Measurements of electricity in the retirement home building started in the summer of 2013. The first tenants moved in October 2013 and the retirement home was not fully occupied before the beginning of 2014. Therefore, it is problematic to get a full year of representative data concerning the electricity use in the building. Detailed hourly measurements [kWh] for the building are listed below.

- Solar power generation from the PVs.
- Electricity use for comfort cooling.
- Electricity use for buildings services, including electricity use for comfort cooling and kitchen cooling and electricity for lighting (of common spaces), pumps, fans and elevators.
- Other activity-related electricity use in the building, including electricity to the retirement home activities such as the industrial kitchen, social areas, office areas.

Monthly surplus electricity delivered to the grid has been provided by the electricity retailer.

Note that no measured values have been statistically adjusted due to the outdoor temperature and solar radiation and their duration for a normal year. The summer of 2014 was warmer than a normal summer in Sweden, and can, in that sense, not be considered as representative for a normal year. This means that it is not straightforward to compare these values with design values.

Results and analysis

Coverage rates on an annual and monthly basis

The first year of measurements (Sep 2013 to Aug 2014) show that 72.8 MWh (10.0 kWh/m²,year) solar power was generated in the PV plant, that 5.3 MWh (0.7 kWh/m²,year) electricity was used for cooling and that 130.9 MWh (18.0 kWh/m²,year) electricity was used for all building services (including comfort cooling). Thus, there is no doubt that the solar power generation at the retirement home reaches its targets of 100% coverage rate of the power used for cooling and 40% coverage rate of the power used for all buildings services on an annual basis. In fact, as much as 56% of the power used for all building services was met by solar power using measurements for the first year. The solar power generation from the PV plant over the year was higher than estimated (134 instead of 113 kWh/m² PV).

Table 1. Technical performance of cooling and PV system.

Photovoltaics	
Photovoltaics installed	Hanwha SolarOne HSL 60 Poly
Installed capacity	330 modules, 245 W/module, total PV area 545 m ² mounted at 6°
Estimated power generation	61 500 kWh, year 112.8 kWh/ m ² , year
Compression chillers	
Chillers installed	Two Mitsubishi PUHZ-P200YHA3 chillers and one Mitsubishi PUHZ-P250YHA3 chiller
Installed cooling capacity	60 kW (19×2 kW × 2 and 22 kW)
Energy efficiency ratio according to the manufacturer	2.6 for both chiller models
Energy efficiency ratio according to Eurovent (35°C outdoor temperature)	3 for both chillers (3.04 for PUHZ-P200YHA3 and 3.01 for PUHZ-P250YHA3) [7]

Using monthly instead of annual measurements, still as much as 97% of the solar power generated can be used for building services. In other words, the remaining power generated is very small compared to the use of building service electricity on a monthly basis. Calculated coverage rates based on total solar power generated and total electricity use for comfort cooling and building services each month are presented in **Table 2**. The coverage rates for comfort cooling are 100% over the entire year, whereas the share of solar power used for building services varies from a few percentages up to a full coverage.

Coverage rates on an hourly basis

According to national energy requirements in Sweden, only the power generated that can be used within the building for building services can reduce the specific energy use of the building [8]. The measurements of the electricity used for building services and the solar power generated each month during the first year of operation are presented in **Figure 3**. In order to see how much electricity was used for comfort cooling each month, the electricity used for building services (the left column in **Figure 3**) is split into electricity used for cooling and electricity used for other building services. The measurement results show that electricity used for building services seems to be quite constant during the year, except for the summer months when the need for cooling increases.

The measurements of the power generated in the PV plant are presented in the right column in **Figure 3**. In order to see how much of this electricity that “instantly” (on an hourly basis) can be used within the building, the column is split into electricity delivered to different appliances and services. They are prioritised as follows: electricity to the comfort cooling plant, to other building services as well as to other services and appliances in the retirement home. The remaining power generated is delivered to the grid.

The monthly values of surplus electricity delivered to the grid show that only a very small percentage of the electricity generated (6%) cannot be used within the building on an hourly basis. Evidently, the combination of building service electricity – for cooling and other purposes – and activity-related electricity seem to provide a very good match to the solar power generation in this particular case. However, a substantially smaller percentage of the total solar power generation can be used when only building services are accounted for (63% compared to 94%).

The coverage rate, the share of electricity for building services that comes from the PV plant, varies between 3% and 60% over the months when considering the hourly use of electricity, as shown in **Table 2**. When hourly load match of generation and use is taken into account, the coverage rate on an annual basis will be considerably lower than if basing the coverage rate on annual or monthly measurements. The annual coverage rate for building services based on hourly measurements is 35%, which is still close to the 40% target set on an annual basis.

Table 2. Coverage rates of solar power used for comfort cooling (CC) and building services (BS incl. CC) based on monthly and hourly measurements. Note that there is a lack of measurements for June 2014, which has been assumed to have coverage rates equal to the ones found in May.

Month	Coverage rates on a monthly basis		Coverage rates on an hourly basis	
	CC	BS (incl. CC)	CC	BS (incl. CC)
Sep-13	100%	73%	49%	37%
Oct-13	100%	28%	51%	23%
Nov-13	100%	11%	49%	11%
Dec-13	100%	3%	31%	3%
Jan-14	100%	6%	28%	6%
Feb-14	100%	16%	34%	14%
Mar-14	100%	52%	26%	36%
Apr-14	100%	82%	58%	47%
May-14	100%	100%	85%	60%
Jun-14	100%	100%	85%	60%
Jul-14	100%	84%	88%	58%
Aug-14	100%	74%	87%	51%

Using hourly measurements, instead of monthly or annual measurements, when calculating the annual coverage rate of the power used for all comfort cooling,

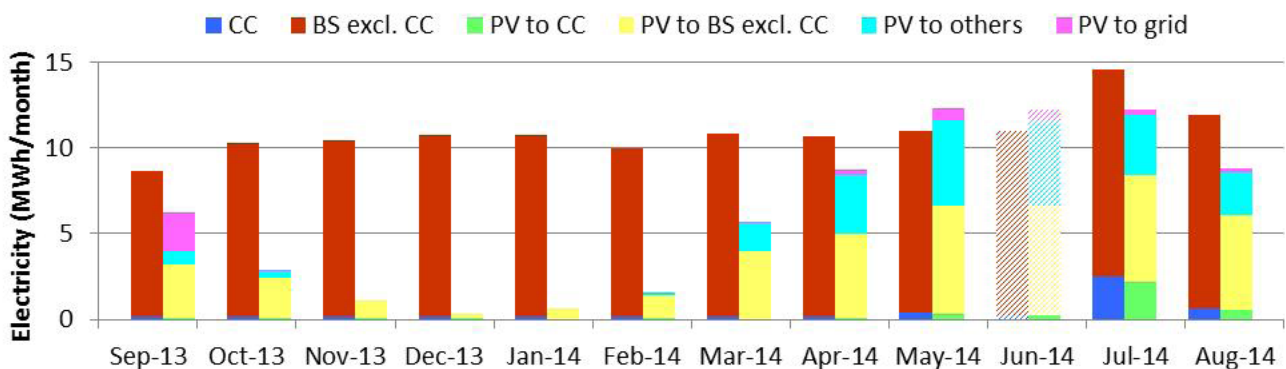

Figure 3. Monthly use of electricity (left columns) for comfort cooling (CC) and for other building services (BS excl. CC) as well as monthly generation of solar power in the PVs (right columns). The power generation is divided into four different destinations based on the hourly load match and the following prioritisation of usage categories: PV to comfort cooling (PV to CC), PV to other building services (PV to BS excl. CC), PV to others and PV to grid. Note that there is a lack of measurements for June 2014, which has been assumed to have PV generation and coverage equal to the ones found in May.

results in a coverage rate of 75% instead of 100%. Nevertheless, due to the intermittent nature of the solar power generation, it would be practically almost impossible to supply 100% of any load over a short time without the possibility of storage. Only a short moment of mismatch means that the goal cannot be reached. Solar power coverage rates for the comfort cooling electricity based on hourly load match are presented in **Table 2**. Highest coverage rates during the summer reach almost 90%, while they are much lower during the winter months.

It should be noted here that the winter coverage might not be representative, since the cooling need is so small. The measurements registered for the comfort cooling are only in full kWh. During the winter it can take many hours for the electricity meter to count one full kWh. If the meter changes to next kWh during the night when no solar power is generated, the last kWh will be counted as not covered even though most of it could actually have been supplied by solar power earlier in the day. This may lead to a probable underestimation of the yearly coverage on an hourly basis.

Detailed comparison of power demand and power generation

Figure 4 presents the measurements of solar power generation, electricity used for comfort cooling and all building services for a week in July 2014. **Figure 5** presents the calculated net electricity when comparing solar power generated and total building service electricity for the same week. At first glance, it is clear that the maximum power generated at midday by the solar PV is more than enough to cover the peak load of the cooling and other building services for all days of this week. There is also a correlation between the need for cooling and generation of solar power. There is a tendency for the comfort cooling to linger on late in the evenings when the solar power generation has decreased, which is one important reason for mismatch in this system.

Even though there is a correlation between them, the solar power generation and the need for cooling are not always present simultaneously. Different types of weather are sources of mismatches, e.g. warm, cloudy summer days when need for cooling might be present but solar power generation is low.

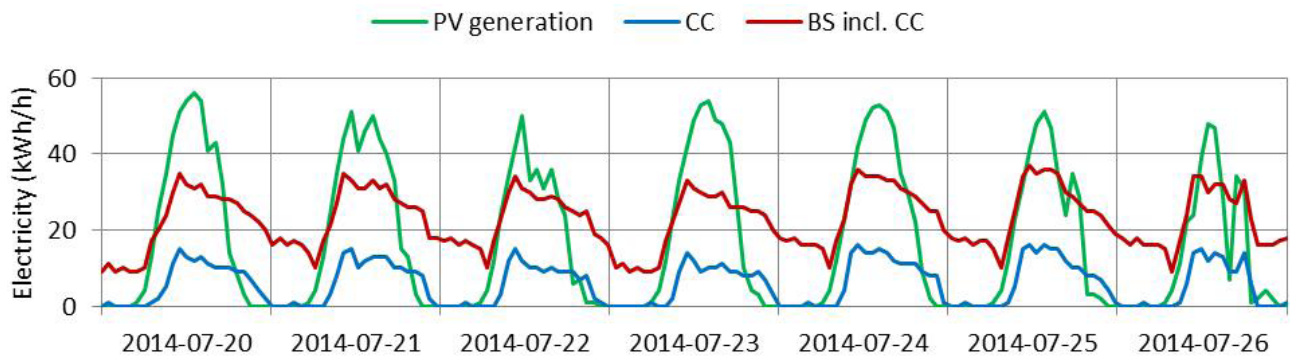

Figure 4. Hourly production of solar power and hourly use of electricity for cooling and of total building service electricity (including power used for cooling) one week in July 2014.

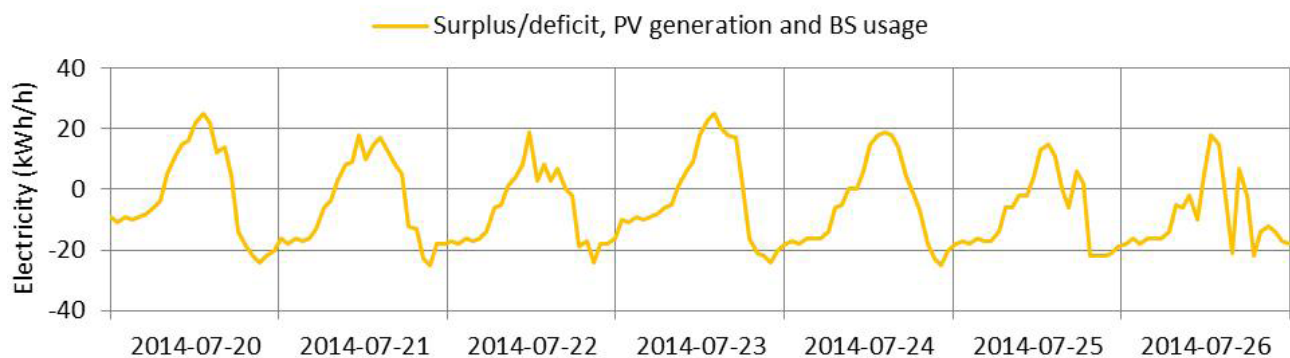

Figure 5. Hourly net production of solar power, defined as solar power production minus total building service electricity (including electricity for cooling) one week in July 2014. A positive result means overproduction and a negative result means there is need for additional electricity from the grid.

Conclusions

Solar power and comfort cooling – a perfect match?

This paper presents and evaluates how well the load demand and the solar power generation coincide hour by hour and how this affects the fulfilment of the coverage rate targets as well as how it affects the amount of surplus power generated in the PV plant at the retirement home in the passive house area Vallda Heberg, in Sweden.

According to the results presented in this paper, there is no doubt that the solar power generation at the retirement home reaches its targets the first year – 100% of the power used for cooling and 56% of the power used for all business services were met by solar power on an annual basis. If hourly measurements are instead used when calculating the coverage rates, they are considerably lower but are still as high as 35% and 75%, respectively. Since a large share of the rest of the electricity generated each hour can be used for other appliances and services in the retirement home, only 6% of the solar power generated was delivered to the grid, according to measurements for the first year.

In this particular case, the presence of electricity-driven chillers does not have a large influence on the share of solar power in electricity used for building services on an annual basis. This is explained by the relatively small need for electricity for comfort cooling compared to the total building service electricity.

Is solar cooling in net zero energy buildings a good idea?

Of course, measures to reduce the need for comfort cooling are the first actions to be taken when designing a building. In cases where there is still a limited comfort cooling demand, there is a good potential of meeting this demand by solar power. Using the first passive house-certified retirement home in Sweden as a case, this paper illustrates that a comfort cooling plant combined with photovoltaics could be an interesting solution to achieve net zero or near zero in energy use for comfort cooling thanks to the high correlation in power generation and use of electricity.

As shown in this study, the answer if solar power used for comfort cooling could be a good solution for achieving net zero energy use for cooling depends on the definition – if it refers to net zero energy use on an annual basis or an hourly basis. ■

Acknowledgements

This study is part of a demonstration project of the entire passive house area in Vallda Heberg which is focused on the evaluation of energy performance, indoor climate and energy system solution. The authors want to acknowledge the financiers of this project: LÅGAN – a collaborative project between the Swedish Construction Federation, the Swedish Energy Agency, Region Västra Götaland, Formas and others; SBUF – the Swedish construction industry's organisation for research and development; NCC Construction Research and Development. Thanks to Stephen Burke, NCC Construction Sweden AB, for reviewing the paper.

References

- [1] DIRECTIVE 2010/31/EU OF THE EUROPEAN PARLIAMENT AND OF THE COUNCIL of 19 May 2010 on the energy performance of buildings (recast).
- [2] District cooling, balancing the production and demand in CHP, IEA District Heating and Cooling Annex V, Report 1999:T2, published by November <http://www.iea-dhc.org/scanned_brochures/8DHCT99-02LR.pdf> (25.01.12).
- [3] Ecoheatcool, Work packages, Brussels: Euroheat and Power, 2006, <<http://www.euroheat.org>> (16.10.14).
- [4] Photograph by Bergslagsbild AB.
- [5] FEBY - Forum för energieffektiva byggnader, Specification of requirements for passive houses (in Swedish), <<http://www.nollhus.se/rapporter/>> (16.10.14).
- [6] Photograph by Anders Ljungberg.
- [7] Eurovent certified performance, <<http://www.eurovent-certification.com>> (16.10.14).
- [8] Swedish Building Regulations (Boverkets Byggregler Avsnitt 9 BFS 2011:6 ändrad t.o.m. BFS 2014:3, in Swedish), Boverket – the Swedish National Board of Housing, Building and Planning, <<http://www.boverket.se>> (21.10.14)..

THE RIGHT PRODUCT IN THE RIGHT PLACE



DEFINING A **WORLD OF COMFORT** WITH PURMO

ONE SUPPLIER, MULTIPLE BENEFITS

In a world of choice, few things are simple. As an contractor, architect or specifier, you are faced with countless decisions every day, as you work to ensure your plan comes perfectly to life. Thankfully, there is one decision we can help you with— which supplier to choose when you're working on how best to provide the perfect indoor comfort for your project.

LONG HISTORY OF RELIABILITY

Purmo is part of Rettig ICC, a global leader in radiators and underfloor heating. One supplier, with a vast array of products and an international logistics network to make sure they reach you on time, every time.

PROVEN AND TRUSTED

When you choose Purmo, you choose

a reliable partner with over 60 years of experience. We pride ourselves in being the first choice for architects and specifiers the world over. They keep coming back because of our quality, reliability and service.

Take a look at what we offer on our website www.purmo.com



Interview of REHVA Board Members on nearly Zero Energy Buildings

The following interview with REHVA Board Members was conceived as the follow up of a previous Board members' interview about nZEB done in the REHVA Journal issue 3/2011. It is intended to be an input for critically facing the first deadline imposed by EU recast for Member States, the definition of intermediate targets toward nZEBs for 2015.

We asked three specific questions to the interviewed Board Members:

- 1) What is still the biggest challenge to reach 20-20-20 target in EU?
- 2) What is the most important action taken in your country towards nearly Zero Energy Buildings?
- 3) Which are the most promising HVAC system technologies to give a boost to buildings energy efficiency?



STEFANO PAOLO CORGNATI, Italy
REHVA Vice-President until 2017

1) What is still the biggest challenge to reach 20-20-20 target in EU?

– Dealing with buildings, the real challenge is the integration among the three 20-20-20 targets. Currently, actions are being implemented for each of these goals: reducing energy consumption and increasing energy efficiency, increasing the share of renewable energies and reducing CO₂ emissions. In my opinion, in next years these strategies, which now are running in parallel rails, should become organically integrated. To reach this goal in new and retrofitted buildings design, the new chal-

lenge is keeping in mind that the loop “reducing energy demand-rising energy efficiency-using renewable energy- lower CO₂ emissions” needs to be faced from the very beginning of the design process by all the actors together at the same decision-making table.

2) What is the most important action taken in your country towards nearly Zero Energy Buildings?

– In Italy, nowadays the major theme of nearly Zero Energy Buildings is coupled with the energy retrofit of the existing building stock. At the current stage, significant incentives are given for buildings' retrofit, with two main measures settled at the legislative level: **1.** tax cuts for buildings' refurbishments, **2.** tax incentives for implementing energy efficiency measures, ranging from thermal insulation improvement to testing of innovative technologies for energy production. In my view, to make nZEBs economically competitive - objects to be sold in today's buildings market - there is a need for government subsidies.

3) Which are the most promising HVAC system technologies to give a boost to buildings energy efficiency?

– Looking at the Mediterranean countries scenario, the most promising technologies in the HVAC market sector are the mechanical ventilation systems with heat recovery and dehumidification, because of their poor implementation in this area. A significant increase in these installations can be foreseen for summer and winter heat recovery systems and for heat pumps, as the general trend is now rapidly moving toward all-electric buildings, possibly with electricity produced on site. Of course, this kind of systems requires a consistent improvement in heat pumps energy efficiency and an increasing use of geothermal and groundwater heat pumps, when technically and economically feasible. Dealing with cooling, another big issue is finding the tradeoff between natural and mechanical cooling. The combined role of thermal mass, which must be properly designed, with natural / mechanical ventilation strategies is still a theme to be investigated and developed in warm and hot climate.



KAREL KABELE, Czech Republic
REHVA President until 2016

1) What is still the biggest challenge to reach 20-20-20 target in EU?

– Year 2020 is approaching and with it the question mark whether the ambitious goals of the European Community in the field of energy performance of buildings and reduction of external environmental load are met. Member States already elaborated steps leading to these goals, European directives are implemented in national legislation and in most countries measures to improve the energy performance of buildings have already come into force. However, an unsolved question is how the market, investors and users, who largely affect the actual energy use by their behaviour, will respond to this pressure. A warning signal is that, although the requirements for buildings have tightened considerably in the recent past, the total energy consumption did not record significant decrease so far.

With the implementation of energy efficiency measures in buildings, new problems are arising, especially dealing with indoor environmental quality and its potentially fatal consequences: for instances, deaths for CO poisoning in sealed homes with gas appliances, the formation of harmful mould,

overheating of buildings. These issues are potential disruption causes toward the achievement of the 2020 objectives. However, one of REHVA's priorities is to promote holistic solutions for energy efficient, healthy and smart buildings. Therefore I am confident that these teething problems of modern buildings will be soon overcome and that, thanks to more than 100.000 top European experts in our member organizations, Europe will continue to pioneer and be a role model in the field of buildings energy efficiency.

2) What is the most important action taken in your country towards nearly Zero Energy Buildings?

– The definition of nearly zero energy as it was published in Directive 31/2010 EC gives great freedom in the interpretation and space for precision at the Member States level. Czech Republic has its own nearly Zero Energy Building definition settled in the Implementing Regulations to the Act on energy management. This definition, expressed numerically by tightening the requirements for thermal insulation of the building envelope and for the share of non-renewable primary energy, is currently being tested in order to verify that these dispositions entail an actual reduction in

energy consumption in buildings. Czech Republic has a long tradition in this field: already in the 90s of the last century, during the development of electric direct-heating, energy evaluations for buildings with very low heating energy consumptions were developed.

3) Which are the most promising HVAC system technologies to give a boost to buildings energy efficiency?

– I believe we can expect a breaking period in view of HVAC systems used in buildings. Dramatic changes in the ratio of energy needs for heating, cooling, hot water and lighting necessarily require a new approach to study and develop the energy systems of buildings. The days when heating was a crucial indicator of the energy performance for Central Europe are over. Modern heating and other energy systems ensuring the quality of indoor environment must be dynamic, with minimal or zero power consumption in stand-by condition, which is due to qualify for the building envelope for the large majority of its running time. At the same time, there is clear pressure on the exploitation of renewable energy sources, so we can expect to solve the problem not only on the conversion side but also in terms of energy storage.



JAREK KURNITSKI, Estonia
REHVA Vice-President until 2016

1) What is still the biggest challenge to reach 20-20-20 target in EU?

– Energy Efficiency is the challenge. EU simply does not seem to have enough capacity to renovate as many buildings as needed to achieve this target. However, many Member States have implemented regulations boosting renovation volumes and deep integrated renovations, which are the only way to tackle indoor climate and energy performance improvements at the same time.

2) What is the most important action taken in your country towards nearly Zero Energy Buildings?

– There are some good national nZEB applications in Denmark, in Estonia and in few others, but, as a whole, national energy calculation methodologies and regulatory frameworks still need major developments to enable successful implementation of nZEB targets European wide. nZEB requirements do not necessarily need to be too sophisticated at the end of the day they are just primary energy limit values for major building categories. However, to set such kWh/m² values (for building categories listed in EPBD Annex I), comprehensive methodology and input data definition are needed. Energy calculation methods and tools are an issue – available commercial simulations tools which are easy to use, flexible and

reliable have needed development efforts measured in tens of man-years. If authorities do not accept such tools, many years are needed to develop national ones. EN standard package under revision (2nd generation EPBD standards) will provide good guidance, but upgrading and development of national tools takes time.

National nZEB applications launched so far have shown major systemic problems that are not easy to solve in short time perspective. The primary energy requirement has been between 20 and 200 kWh/m²y and in about half of MS on site renewable energy production has been not yet implemented in energy calculation methodology. National applications not consistent at all and with different level of ambition have made inter-comparison almost impossible.

One of the most positive developments in EPBD implementation has been the cost optimality approach. Cost optimality of existing energy performance minimum requirements has been tested in MS with net present value of global cost calculation method which was launched as European regulation accompanying the directive. As a result of this exercise, many MS have already shifted minimum requirements to the cost optimal level. The problem is that in many MS it has not been possible to bridge

the gap between the cost optimal energy calculation methodology and national energy calculation methods used in the compliance assessment. Implementing the key elements of the cost optimal methodology – delivered and exported energy and non-renewable primary energy indicator – to national energy frames, and allowing the same tools that have been used in cost optimal calculations (simulation tools) could solve the problem of nZEB national applications. National authorities should understand that nZEB is not just setting couple of new numeric requirements, but in most cases a major upgrade of the whole energy calculation and regulatory system. In the communication to MS, guidance by European Commission is taking a crucial role, as REHVA has already published nZEB guidance and European standards will soon be available.

3) Which are the most promising HVAC system technologies to give a boost to buildings energy efficiency?

– I do not see any problem with HVAC or other technologies needed for nZEB. I have written one of the most technical books on cost optimal and nZEB buildings. I do believe that all the technologies we need are already there, and, if properly applied, for an affordable price. The latter one is the issue we should work in the building sector.



New European Commission – Juncker merges Energy and Climate change portfolios

President-elect Jean-Claude Juncker unveiled the new shape of the next European Commission in September 2014 introducing significant changes in the structure and portfolios of the Commission. The new European Commission will be streamlined to focus on tackling the big political challenges Europe is facing among them energy security. A number of portfolios have been reshaped including those related to energy and climate policies.

The new College will have seven Vice-Presidents, six in addition compared to the former structure, who will be in charge of coordinating Project Teams: different commissioners and directorate generals related to the main policy challenges. The **new Vice-president for Energy Union** will steer and coordinate the Project Team called *"A Resilient Energy Union with a Forward-Looking Climate Change Policy"*.

The European Parliament overwhelmingly rejected the first candidate of Juncker, Slovenia's ex-prime minister, Alenka Bratušek as Vice-president for Energy Union, so she withdrew her candidature. As a second choice, Juncker confirmed Slovakia's **Maroš Šefčovič** who was approved by MEPs without problems.

The **former separate portfolios Energy and Climate Action have been merged** under **Commissioner Miguel Arias Cañete** who was approved by the MEPs despite many critical voices including an online petition that attracted nearly 600,000 signatures and a vocal social media and telephone campaign calling for Cañete to be rejected.

In his **EP hearing Cañete** defended the merge of the Energy and Climate portfolios and confirmed his intention to promote renewable energy and increased energy efficiency. He stated always having been supporting the proposals of outgoing Connie Hedegaard Climate Action Commissioner. On the questions from the ITRE Committee Cañete listed among his policy priorities to contribute to the imple-

mentation of the 2030 climate and energy framework and develop the legislative framework for energy efficiency, including energy performance of buildings.

According to the hearings and the policy briefing prepared for the EP hearings of Cañete energy efficiency should be enhanced beyond the 2020 objective, particularly in the buildings sector, which shows that sustainable energy expected to be high on the political agenda of the next European Commission. The European Parliament gave its consent to Juncker's new Commission on 22 October. After the formal appointment by the European Council the European Commission will start its work on 1st of November 2014.

More information:

<http://www.rehva.eu/news/>

2030 Climate and Energy Package – disappointing Council decision on energy efficiency

The European Council adopted an indicative 27% energy efficiency target for Europe falling even behind the already unambitious 30% goal presented by the European Commission end of July 2014. Binding 40% GHG emission and 27% RES targets were approved by EU heads of governments.

The heads of European governments approved the 2030 Climate and Energy Package of Europe on it's the Euro Summit on 23-24 October 2014 in Brussels by adopting as headline targets at least 40% GHG decrease compared to 1990, at least 27% share of renewable energy within the EU energy mix and a non-binding, indicative 27% target to improve energy efficiency to be reviewed in 2020 "having in mind an EU-level of 30%".

The approved **energy efficiency and renewable energy targets are close**

or even below the business as usual trends. By abandoning binding energy efficiency target EU leaders sent a weak message to the low-carbon and energy efficient industries that repeatedly called for a binding 40% efficiency target during the preparation of the EU 2030 package.

The Council conclusions state that the **"Commission will propose priority sectors** in which significant energy-efficiency gains can be reaped, and ways to address them at EU level". Since the building sector has the biggest share and

the highest cost effective saving potential in the energy end-use of Europe **REHVA called for targeted support policies that prioritise the building sector and boost cost-effective, high quality renovations** in order to achieve an energy efficient and healthy building stock for Europe in its policy statement published after the disappointing Council decision.

More information:

<http://www.rehva.eu/news/>

REDay2014

–Energy Director General, Dominique Ristori confirms housing as a priority sector

Renovate Europe organised the 3rd edition of the Renovate Europe Day the 5th of November with the title “Securing our energy future through ambitious renovation of buildings” in Brussels with high-level EU policy speakers and presenting local examples of refurbishment programmes.



Dominique Ristori confirmed in his speech about the place of energy efficiency in the EU 2030 energy framework that **housing will be a priority sector within the upcoming EU2030 legislative framework.** Ristori was asked for comments on the disappointing energy efficiency target approved by the European Council on 23 October. He pointed out that after having extremely hard negotiations with member state governments this was the only achievable compromise and confirmed that the Commission would still keep the 30% target in mind. **The EC will also focus its work also on regions and cities,**

which are in many cases much more ambitious than their national level governments.

MEP Jan Olbrycht praised the **improved governance structure of the Juncker’s Commission** in which all the related DGs have to cooperate and coordinate their work. Especially important is the cooperation between DG ENER and DG REGIO that can influence that European Structural and Investment Funds are spent on deep building renovations.

Oliver Rapf, Executive Director presented the outcomes of the latest

from BPIE report on Renovation strategies of selected EU countries. The astonishing results show that none of the analysed Roadmaps are complying with the Energy Efficiency Directive and that the roadmaps submitted by countries reported to be advanced like Denmark or Germany got low scoring, so the study suggests that the EC shall refuse their strategic documents. Renovation Roadmaps are to be reviewed each year by Member States.

The presentations will be available in the Renovate Europe website.



3–6 February 2015
www.aquatherm-moscow.ru



17–20 February 2015
www.aquatherm-novosibirsk.ru



18–21 March 2015
www.aquatherm-spb.com

AQUA-THERM RUSSIA 2015

If you want to grow your business join over 800 exhibitors and check out all the opportunities with Aqua-Therm exhibitions in Russia!

Aqua-Therm exhibitions are the leading in Eastern Europe B2B events for domestic and industrial heating, water supply, sanitary equipment, air-conditioning, ventilation, equipment for pools, saunas and spa.

The shows provide an opportunity to explore the whole Russian HVAC market: Aqua-Therm events in Russia are held in three the most developed regions of the country: Central, Siberian and North-West districts.

Why exhibit at Aqua-Therm exhibitions in Russia?

Exhibiting at the leading shows for the HVAC industry in Eastern Europe will result in tremendous export opportunities for your company.

- Every year Aqua-Therm exhibitions draw thousands of producers, suppliers, distributors, government and industry associates from across the country and all over the world.
- Strong cast of the Russian and international **key market players** introduce the possibility to observe all the crucial projects and solutions.
- The international **brand awareness** provides recognition on the market to show participants as well as extra opportunities for promotion and experience exchange.
- Aqua-Therm Moscow has 18-year experience, well-established status, successful history and reputation. Since 1996, it is

one of the most influential professional events for the HVAC industry in Russia and CIS countries gathering **the whole industry at one B2B platform**.

- Two regional projects in Novosibirsk and St. Petersburg are developed to match the demand of the **new and vast regional markets** possessing strong opportunities for growth and prosperity.
- **Exhibiting in the richest Russian regions** with the high industrial revenue establishes a strong link for all the country covering network and business growth.
- Experience of Aqua-Therm organizers and shows trustworthy agents guarantee the highest quality of services: delivery, custom and travel support make exhibiting the most efficient and comfortable.

Why Russian market is worth entering?

- Russia is the largest country in the world with growing economy. Its advantageous geographical location opens European brands an access to its capacious market characterized by constantly increasing consuming volume and GPD per person
- Expected decrease in entry barriers and creation of new opportunities for foreign countries due to WTO accession.
- Easy accessibility to Kazakhstan and Belarus markets due to membership in the Custom Union.
- Strong consuming growth caused by huge population and economic development (15 cities with a million-plus population, 145 million people in total, over 5 million companies).

- Boosting volume of construction works supported both by commercial sector and government.
- Significant growth in retail industry (approx. 20% in 2013).
- High demand for the modern technologies on the market, especially dedicated to the new levels of energy efficiency.
- Broad opportunities and well enough space for the new brands on the market.

Who Attends?

Over 41 000 professional visitors from all over the country and nearby states (*Joint results for the 3 shows in 2014*):

- Managers and specialists in architecture and building design, construction industry, testing and measuring instruments and systems;
- Oil and gas production and processing companies;
- Energy providers, sanitary and heating appliances facility managers;
- Technicians in cooling, heating, air-conditioning, ventilation, plumbing, bathrooms, pools, saunas and refrigeration equipment;
- Manufacturers, safety technicians, specialists in assessment and certification, logisticians;
- Traders, retailers and wholesalers in the mentioned spheres;
- Government authorities and industry associations.

With their wide range of the HVAC and pool products, professional cast of visitors, actual business program, variety of promotional resources for business and organizers' experience, Aqua-Therm Moscow, Aqua-Therm Novosibirsk and Aqua-Therm St. Petersburg are the only trade fairs in Russia and CIS countries that can claim to offer such high standards.

Participate in Aqua-Therm 2015 in Russia – GROW YOUR BUSINESS!



10 to 14 March 2015
Frankfurt am Main, Germany,
www.ish.messefrankfurt.com

ISH 2015 – Comfort meets Technology

The World's Leading Trade Fair for The Bathroom Experience, Building, Energy, Air-conditioning Technology and Renewable Energies

Comfort meets Technology' is the motto of the next ISH – The World's Leading Trade Fair for The Bathroom Experience, Building Services, Energy, Air Conditioning Technology and Renewable Energies.

"ISH stands for future-oriented subjects, such as resource conservation and the use of renewable energies, as well as demographic change and the associated changing conditions in the fields of water and energy", says Wolfgang Marzin, President and Chief Executive Officer of Messe Frankfurt. At the same time, ISH is the leading trade fair for sustainable sanitation solutions, innovative bathroom design, energy-efficient heating technologies combined with renewable energies and environmentally-friendly air-conditioning, cooling and ventilation technology.

ISH presents technologies and ways in which Europe can decrease its dependence on external energy supplies through the

use of energy-efficient products and renewable energies. Thus, the great horizontal and vertical range of products on show at ISH covers all aspects of future-oriented building solutions. The exhibitors present a complete range of market-ready products and technology, which is unrivalled in terms of variety.

ISH 2015 will be held in Frankfurt am Main from 10 to 14 March. The market and technology leaders have already registered. Messe Frankfurt expects around 2,400 exhibitors from all around the world who will present their latest products and innovations on some 260,000 square metres of exhibition space.

The **ISH Energy** section with building-services and energy technology, renewable energies and cooling, air-conditioning and ventilation technology is located in the western part of the Exhibition Centre, in Halls 8, 9, 10, 11 and the Galleria. There,

visitors will find the entire range of innovative building-system technology revolving around the top motto, 'Energy-efficiency plus', in other words, subjects such as the new energy paradigm in the heating market, the building of the future, holistic sustainability and different technological trends.

Air conditioning, cooling and ventilation technology is shown at ISH under the name Aircontec. There, the industry presents innovative components and systems that, in addition to great energy efficiency, ensure thermal comfort and good interior-air quality. Also to be seen are concepts and solutions for modernisation and new construction work, as well as for dwellings and commercial premises.

Further information about ISH fairs can be found on the internet at www.ish.messefrankfurt.com.

REHVA Annual Conference on – "Advanced HVAC & Natural Gas Technology"

May 8-9, 2015, Radisson BLU Hotel Latvija Conference Centre, Riga, Latvia

- Energy efficient Cooling systems
- Advanced Heating and Ventilation systems
- Sustainable buildings
- Efficient and clean Natural Gas technologies

Contact E-mail: elina.purviske@btgroup.lv

More information: www.hvacriga2015.eu



Halton Foundation grants promote better indoor ENVIRONMENT around the world

Halton Foundation's grant application period has started

Halton Foundation supports non-profit organisations and initiatives that promote wellbeing of people suffering from poor indoor environmental quality for environmental or economic conditions. Halton Foundation welcomes now new applications. Decision on grants will be made in November 2014.

Halton Foundation is a charity organisation that promotes wellbeing of people suffering from poor indoor environmental quality due to environmental or economic conditions. Annual grants are awarded to non-profit organisations, research programs or initiatives promoting the wellbeing of people in indoor environments.

In 2010, Halton Foundation donated its first grant to the Center for Courageous Kids which is a medical camping facility located in Scottsville, Kentucky USA. The Center provides cost-free summer and weekend camps for seriously ill and disabled children and their families. The Halton Foundation grant enabled the Center for Courageous Kids to organise one week summer camp for children with asthma.

The second grant was given in 2012 to the Paul Basch Memorial Foundation to help in its **Himalayan Stove project**. The Stove Project is dedicated to improving the health of the people in the trans-Himalayan region. The organisation provides free, clean-burning, highly fuel-efficient cook stoves to families living in the Himalayas who now cook with traditional, rudimentary stoves over open fire pits inside their homes, consuming excessive amounts of precious fuel and polluting the indoor air to dangerously unhealthy levels.

The third grant was given in 2013 to the University of Reading for a 2-year joint research project between the University of Reading and Chongqing University in China. The project is on School Indoor Environment & Ventilation Control Strategies for Children's Health & Wellbeing and will involve investigating indoor environmental conditions and developing control strategies to mitigate the level of contaminations for the classrooms located in urban areas in order to improve health and wellbeing for school children.

The scope of Halton Foundation

Halton Foundation's scope covers initiatives related to indoor air quality, thermal conditions, breathable particulates and illnesses, conditions or diseases that may result from sub-standard indoor environmental quality.

As a special area of interest, Halton Foundation has identified two global indoor air quality problems: indoor air pollution from the cooking process in developing countries and high levels of outdoor contaminants in indoor air in developed countries:

Developing countries: Developing countries: indoor air pollution born by cooking process

More than half of the world's population, mostly in developing countries, rely on polluting biomass fuels to meet their basic energy needs. Cooking and heating with these fuels on open fires or stoves without chimneys mean the hazardous pollutants and dust particles remain in the indoor air. In such conditions indoor smoke can exceed acceptable particle levels for small particles in outdoor air even 100-fold. The health impacts are significant and disproportionate on women and children as they are the most engaged with the cooking process. Consequently, 56% of all indoor air pollution-attributable deaths occur in children under five years old. (WHO Fact sheet N°292: Indoor Air Pollution and Health, 2005)

Health problems caused by indoor air pollution will also hold back economic development, thus creating a vicious cycle of poverty. It is the objective of the Halton Foundation to positively affect this development and support initiatives aiming at reducing the health problems and deaths caused by the cooking process.



Developed countries: indoor air pollution caused by contaminants from outside air

Studies indicate that the most significant cause of indoor air quality related health problems in developed countries is the contaminants from the outside air. Ambient air quality is three times more significant source of indoor air pollution than dampness, mould and water systems. Therefore, Halton Foundation aims to promote initiatives that are protecting people's health by providing them cleaner air to breathe in indoor spaces for example by developing better ways of purifying the air coming from outside.

How to apply for Halton Foundation grants?

Halton Foundation is looking for new and innovative ways of solving indoor environmental problems. Therefore Halton Foundation welcomes grant applications for different kinds of undertakings supporting the Foundation's mission.

The Foundation grants are either one-time grants for a specific purpose or multi-year grants for no longer than three years. The application period for the Halton Foundation grants is now open. A grant application can be filled out at Halton Group website* and applications must be submitted by latest on October 15, 2014. The selection process of the winning application will be completed by November 15th 2014.

* http://www.halton.com/en_US/about/halton-foundation/applying-for-a-grant



FIRE SAFETY SOLUTIONS FOR PEOPLE AND PROPERTY

Our full product range, focusing on limiting the fire and evacuating the smoke, make us an ideal partner! In the event of a building fire it is critical for people to evacuate safely, to minimize property damage and to give the rescue team better working conditions. Fläkt Woods has well documented Fire Safety solutions and vast application knowledge to share.



ENVIRONMENT
ECONOMICAL
EXPERTISE

>> Learn more at www.flaktwoods.com

PRODUCT RANGE SNAPSHOT



JM Aerofoil[®]
High Temperature Fans



ESAR
Smoke Damper

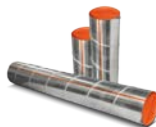

ESAD
Fire Resistant Ducts



FICO[®]
Control System



KSOF
Fire Valves

Over 600 exhibitors at FinnBuild exhibition in Finland

The successful FinnBuild exhibition took place in October 1st -3rd in Helsinki. FinnBuild presented the best expertise, products, services and solutions for construction in its 21st fair. The fair attracted 600 exhibitors that presented their products and services on an over 16 000 m² of floor area.

An extensive technical program was organized within the exhibition. Various professional and trade organizations presented attractive seminars and workshops- One of the most successful technical seminars was the one organized by FINVAC and REHVA titled **"HVAC equipment and systems in nearly zero energy buildings."**

This seminar described how the energy use of buildings can be saved and made more effective. Implementation of the energy policy and objective in Finland were compared to the objectives and policy set by the European Union. The seminar also described the current use of energy in buildings and illustrated opportunities to improve the energy efficiency of building further. An important topic of the seminar was also how to reach in Finland the objectives for zero energy buildings. The main speakers and their topics were:

- Mr Ismo Grönroos-Saikkala from The European Commission (Energy efficiency in the EU employment and climate policy)
- Professor Jarek Kurnitski, REHVA board member (Development of nearly zero energy buildings in Europe and related European standards)
- Mr Jorma Railio, Chair of REHVA Technical Committee (CE-mark and energy labeling of products in Europe)

All presentations are available at <http://www.finvac.org/finnbuild-seminaari>.

During REHVA – FINVAC seminar an award for the most successful trainer of HVAC in continuing education in 2013 was presented.

Next FinnBuild exhibition will take place on Oct 12th-14th, 2016.



FINVAC
The Finnish Association of HVAC Societies

FINVAC is the Finnish member of REHVA representing over 5 000 HVAC professionals in Finland. Its president is Professor Olli Seppänen and secretary general Ms Siru Lönnqvist.

REHVA Annual Meeting and Conference 2015

AHGWTEL, the Association of Heat, Gas and Water Technology Engineers of Latvia is proud to host the REHVA Annual Meeting 2015 which will be held in Riga, Latvia from 6th to 9th May 2015.

This event will bring together leading experts from the international heating, ventilation and air condition community. More than 150 visitors are expected, when AHGWTEL welcomes the members, supporters and guests of REHVA, the Federation of European Heating, Ventilation and Air Conditioning Associations.

REHVA Standings Committee Meetings and the REHVA General Assembly will be held in close connection to the REHVA conference the "Advanced HVAC and Natural Gas Technologies"

This conference will serve as start base for practical implementation of innovative ideas and future practical application of modern technologies. The REHVA Annual Conference will be held on the May 8th and 9th 2014 at the Radisson BLU Latvia Conference Centre. The conference language is English.

The Conference "Advanced HVAC and Natural Gas Technologies" will provide an excellent opportunity for industry, students and academia to meet each other

and create mutually beneficial contacts. In order to highline future trends in buildings' energy efficiency and safe energy supply, special working platforms for the representatives of industry and decision makers will be organized in scope of workshops and meeting.

The conference program consists of technical tours, learning courses, presentations by keynotespeakers and thematic workshops targeted at developments in advanced HVAC and natural gas technologies.

This time apart from traditional emphasis on developments in the field of building engineering there will be a special focus on promotion of student engagement and better awareness of international research cooperation and professional networking. The special student sessions "REHVA conference special students

sessions" will be organized in scope of conference "Advanced HVAC and Natural Gas Technologies".

For more detailed information on conference topics, registration, application deadlines and travel information, please see www.hvacriga2015.eu.



Federation of European Heating, Ventilation and Air Conditioning Associations

6 to 9 May 2015
Riga, Latvia,
www.hvacriga2015.eu



RADISSON BLU LATVIA CONFERENCE CENTRE

REHVA Guidebook on GEOTABS

This REHVA Task Force, in cooperation with CEN, prepared technical definitions and energy calculation principles for nearly zero energy buildings required in the implementation of the Energy performance of buildings directive recast. This 2013 revision replaces 2011 version. These technical definitions and specifications were prepared in the level of detail to be suitable for the implementation in national building codes. The intention of the Task Force is to help the experts in the Member States to define the nearly zero energy buildings in a uniform way in national regulation.

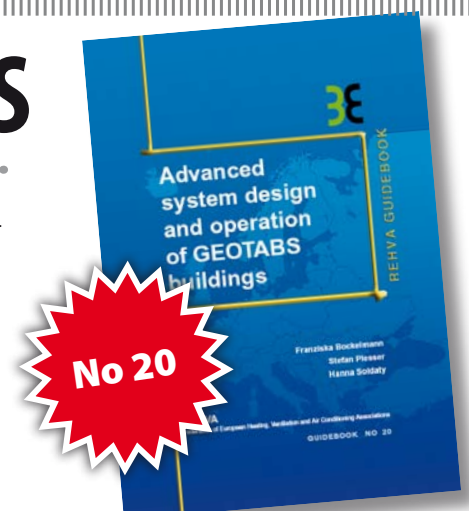

No 20

Integrated Design: Lessons learned from good practice examples

Integrated design is a proven method of achieving high-performance buildings that meet the set goals without sacrificing architectural quality or causing excessive costs. Stakeholders start to collaborate within the very early phases of the project.

Good practice example Smart Campus, Vienna, Austria

Before initiating the design phase, a "mood-board" was developed together M.O.O.CON by capturing the corporate identity in images which serve as a significant source of inspiration for architects. The Wiener Netze was perceived as: trust worthy, reliable, honest, assertive, practical, tolerant, cooperative. The new building should represent these characteristics in front of clients and the surroundings. To comply with these requirements an anonymous, two-stage competition for general planners was organized in Europe. Since the company's core business is energy supply, the project shall be exemplary without the employees losing their comfort. The target was to build an energy efficient building and to apply renewable energies wisely as well as to make users aware of their usage patterns.

Some more details on the project and on the ID process.

- Type of the building: service building
- Gross floor space: 93,000 m²
- Staff: 1,400
- To be completed: 2016
- The administrative building is the biggest building with passive house quality in Europe.
- 50-60% of the energy used comes from renewable energy sources.
- Special emphasize was given to life cycle costs. The method www.lzk-tool.at revealed a high degree of accuracy since the investment costs for the winning project calculated before the competition still remained the same during the final design phase. The LCA helped choosing the right building materials.

- The design team was not composed by the same people during the whole process but the core team accompanied the project through the entire process.
- The multidisciplinary team increased the effectiveness of the design phase. Thanks to their expertise they were able to make decisions very quickly.
- The team created interfaces between individuals and activities in order to avoid problems during the process. Experts, decision makers, responsible for user matters as well as appraisers and civil engineers supported the core team in every phase of the project. The design of the detailed engineering serves as a good example. First a pool of user representatives and appraisers was established. Then regular weekly meetings were held and suitable people from the pool were chosen to share their user or expert perspective and to help with the detailed engineering. This way high user satisfaction could be ensured.

General lessons learned and suggestions from European pilot projects

Every partner has evaluated each pilot project and gathered information about lessons learned. In almost all pilot projects good communication has been mentioned as one of the key activities to achieve a great project result. Good communication between the project team members in the initial interaction phases dramati-

cally reduces system interaction problems during subsequent phases, as well as improves a team's common understanding of the potential future building development and operation problems and possible related solutions.

It is important that the client understands the advantages and benefits of applying an ID process. In **Figure 1**, tasks and related costs can be found. Furthermore the role of an ID facilitator is crucial. If a facilitator becomes involved – as early as possible – various elements can still be influenced and directed.

All design team members must understand how they are expected to contribute in the various planning phases to the whole team. There is a huge need of clarity about what the design team has to do and how the ID process works. A major challenge is to keep the iterative solution methodology ongoing and not falling back into the traditional way of working.

The result of several projects was that there is a need of a better file sharing system, where project team members can work in parallel in the same documents at the same time. Various programs linked to BIM-system have been used.

STEFAN AMANN, e7 Energie Markt Analyse GmbH, stefan.amann@e-sieben.at

Good practice examples and a comprehensive report on lessons learned can be found at www.integrateddesign.eu.

TASKS	COSTS	COMMENTS
Concept and Pre-design	5 - 10 % more	Based on experience
Detailed engineering	< 5 % more the first projects 5-10% less in the next projects	Based on experience – smoother process caused by more detailed concept design
Building costs	5 – 10 % more	3-6 % for Passive houses
Operational costs	40 – 90 % less	Based on experience
Building faults	10 – 30 % less	Because of better planning and better follow up during construction

Figure 1. Estimations of reduced/increased costs connected to ID

SOURCE: ID PROCESS GUIDE – WWW.INTEGRATEDDESIGN.EU

Integrated Design: National activities towards widespread use of NZEB

The IEE-project MaTriD project aims to support the implementation of the Directive on the Energy Performance of Buildings. Therefore, an ID Process Guide has been developed and pilot projects have been accompanied.

Major Outputs

The major outputs and results are the following:

- Establishing a global understanding among building developers and designers with respect to the advantages and requirements of IED;
- Strengthening the know-how in applying IED by improving availability of IED procedures, guidelines and contractual stipulations;
- Large scale test for integrating IED in design processes in 10 partner countries: Austria, Greece, Italy, Norway, Sweden, Slovenia, Slovakia, Poland, Latvia, UK.
- Broad dissemination and promotion of IED on the national level as well as on the EU level

The IED Tool-Kit

In the frame of the project a practical and user friendly tool-kit on integrated energy design has been elaborated in order to be directly used by the design teams (property developers, architects, engineers etc). The core document of the tool-kit is the Integrated Design Process Guide (Figure 1).

Accompanying documents are the Client Brief, the Tenant Brief, Scope of Services and Case Studies referring to ID as a means of achieving NZEB.

The ID Tool-kit has been translated and adapted to national regulations and circumstances. In each participating country the set of documents in national language has been developed including general standards for ID, templates for architecture briefings and planning contracts, and national standards for architecture competitions for NZEB.

The European Tool-Kit and its national adaptations can be found at www.integrateddesign.eu.

To achieve buildings with high energy performance it is important that ID is being used from the very beginning of the project to make sure all energy related questions are discussed as early as possible in the planning process. A well prepared kick-off workshop is mentioned as important for a good ID process from several projects. **Figure 2**

provides an overview of the ID process over the time.

Integrated Design in building projects

The core of the project is the application of ID process in the building design phase of pilot projects. About 20 pilot projects have been accompanied from the first idea of the project until the detailed planning phase. The following issues have been taken into account:

- Suitability for ID
- Aim of the project to achieve an energy performance close to NZEB
- Possibility to influence the design process from the beginning
- Replication potential
- Size: large project with a complex design process rather than small projects with simple design processes

All pilot projects can be found here: <http://www.integrateddesign.eu/pilot-projects/index.php>

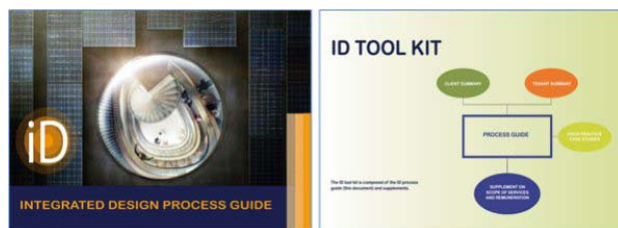

Figure 1. The Integrated Design Process Guide.

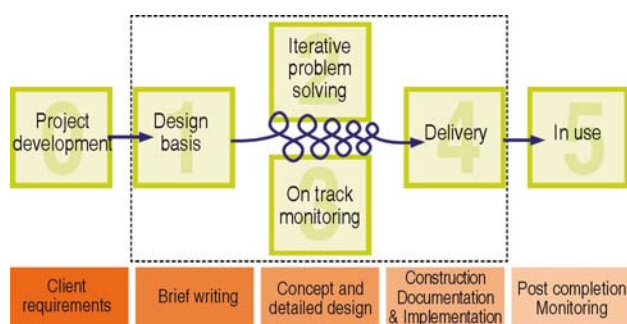

Figure 2. Overview of the ID process.

Training sessions with experts

Already 3 training sessions have been carried out among Europe. The fourth and last training session will be held on 26 November 2014 in Vienna, Austria. Lessons learned from ID projects and policy recommendations will be presented. This will be a common event between both IEE projects MaTriD and the AIDA.

STEFAN AMANN, e7 Energie Markt Analyse GmbH, stefan.amann@e-sieben.at

For more information and downloads about the project please visit: <http://www.integrateddesign.eu>

About MaTriD: MaTriD (Market Transformation Towards Nearly Zero Energy Buildings Through Widespread Use of Integrated Energy Design) is a research project in the framework of the European "Intelligent Energy Europe" program and aims to contribute to a wide spread market adoption of Integrated Energy Design as a major prerequisite for cost-efficient nearly zero energy buildings.

VDI-Guidelines published October-November 2014

VDI 2083/8.1 "Cleanroom technology; Air cleanliness by chemical concentration (ACC)"

This standard deals with the chemical contamination of clean environments. It describes the phenomenon as such, metrology and control of air contamination by gaseous chemicals. This standard has been harmonised with the standard DIN EN ISO 14644-8; the latter, however does not address the subjects of metrology or control of airborne chemical contamination (formerly termed AMC).

D VDI 2083/9.2 "Cleanroom technology; Consumables in the cleanroom"

This standard applies to all consumables used in contamination-controlled areas; examples are gloves, garments, shoes/over-shoes, packaging materials, wipers, masks, paper. The standard describes the generic characteristics of these types of products as well as cleanliness-related properties and testing. The focus is on particulate and airborne chemical contamination. In addition this standard contains guidance on the selection of products with branch- and process-specific requirements and logistics in mind.

D VDI 3805/2 "Product data exchange in the Building Services; Heating value assemblies"

Based on VDI 3805 Part 1, the standard describes a manufacturer and IT system independent and unified data format for the exchange of product data for heating value assemblies used in building services.

VDI 3809/2 "Testing of building installations; Firefighters lifts"

Firefighters lifts are subject to special requirements, providing means of access and escape route for the fire service in case of fire. Life and physical safety of the firefighters in action depend on the safe and reliable functioning of such lifts. Requirements are specified, among others, in DIN EN 81-72. In addition, there are existing lifts in accordance with TRA 200 and several regional fire services maintain lists of requirements. This standard offers a unique harmonised checklist allowing operators and testing institutions to carry out recurrent tests of such lifts.

VDI 3807/2 "Characteristic consumption values for buildings; Characteristic heating-energy, electrical-energy and water consumption values"

This standard applies to the use of characteristic energy and water consumption values for buildings supplied with heating energy, electrical energy and water, especially where values for individual buildings are compared to the averages and standard values given in this standard. The values given in this standard are based on measurements of consumption during the years 2004 and 2005 in Germany. Where characteristic energy and water consumptions of buildings in other countries are compared to the standard values given in this standard, the boundary conditions to be applied in those countries (standards for thermal insulation, climate and typical use) must be taken into consideration.

D VDI 3807/3 "Characteristic consumption values for buildings; Characteristic water consumption values"

This standard applies, in addition to VDI 3807 Part 2, to the use of characteristic water consumption values for buildings, especially where values for individual buildings and individual periods of consumption are required. The standard also helps property owners to identify the sources of irregularities and disturbances in water consumption

VDI 3807/5 "Characteristic consumption values for buildings; Partial characteristics for thermal energy"

This standard specifies the determination and use of partial characteristics for thermal-energy consumption, either calculated or derived from measured values. The standard helps to determine partial characteristics using measured final thermal energy consumptions of a building, to assess and evaluate these characteristics. Typical and atypical uses are taken into account. The described methods help, in particular, to identify potential for saving by comparing values to reference values for similar buildings or premises.

D = Draft Guideline

ACREX[®] India 2015

26-28 FEBRUARY 2015
BIEC, BANGALORE



South Asia's largest exhibition on Air Conditioning, Ventilation, Refrigeration & Building Services

along with

Knowledge enhancing Workshops & Panel Discussions steered by Global Experts

DEDICATED PAVILIONS



Curtain Raiser Partner:



Platinum Partner:



Titanium Partner:



Smart Homes Pavilion Partner:



SOBHA
PROJECTS & TRADE PVT. LTD.



Silvan Innovation Labs
Enabling Smart Spaces

Silver Partners:



Silver Partners:



Bronze Partner:



Organizer



Indian Society of Heating
Refrigerating & Air Conditioning
Engineers

www.acrex.in

Endorsed by



Event Producer: **NÜRNBERG MESSE**

For more information please contact:

NürnbergMesse India Pvt. Ltd.

E: kavita.sharma@nm-india.com / mansi.chawla@nm-india.com / T: +91-11-47168888



Events in 2014 - 2016

Conferences and seminars 2014

November 26	Workshop on Integrated Design	Vienna, Austria	www.integrateddesign.eu
December 3-5	45 HVAC&R International Congress	Belgrade, Serbia	www.kgh-kongres.org
December 10-12	9th International Conference on System Simulation in Buildings - SSB2014	Liege, Belgium	www.ssb2014.ulg.ac.be

Conferences and seminars 2015

January 24-28	2015 ASHRAE Winter Conference	Chicago, Illinois, USA	www.ashrae.org/membership--conferences/conferences/2015-ashrae-winter-conference
February 25-27	World Sustainable Energy Days 2015	Wels, Austria	www.wsed.at
April 16-18	International Conference Ammonia and CO2 Refrigeration Technologies	Ohrid, Republic of Macedonia	www.mf.edu.mk/web_ohrid2015/ohrid-2015.html
April 27-28	37th Euroheat & Power Congress	Tallinn, Estonia	www.ehcpcongress.org/registration/
May 6-7	REHVA Annual Meeting	Riga, Latvia	www.hvacriga2015.eu
May 8-9	REHVA Annual Conference "Advanced HVAC and Natural Gas Technologies"	Riga, Latvia	www.hvacriga2015.eu
May 18-20	Healthy Building 2015 Europe	Eindhoven, The Netherlands	www.hb2015-europe.org
June 14-17	International Building Physics Conference	Torino, Italy	http://ibpc2015.org/
June 27-29	SuDBE 2015 - International Conference on Sustainable Development in Building and Environment	Reading, United Kingdom	www.sudbe.com
August 16-22	IIR International Congress of Refrigeration	Yokohama, Japan	www.icr2015.org
September 10-11	CLIMAMED	Juan Les Pins, France	http://aicvf.org/blog/actualites/climamed-congress-juan-les-pins-10-et-11-septembre-2015/
October 20-23	Cold Climate HVAC	Dalian, China	www.coldclimate2015.org
October 26-28	11th International Conference on Industrial Ventilation	Shanghai, China	www.ventilation2015.org

Exhibitions 2015

January 26-28	2015 AHR Expo	Chicago, Illinois, USA	www.ahrexpo.com
February 3-6	AQUATHERM Moscow	Moscow, Russia	www.aquatherm-moscow.ru/en/
February 17-19	AQUATHERM Novosibirsk	Novosibirsk, Russia	www.aquatherm-novosibirsk.ru/en/
February 26-28	ACREX India	Biec, Bangalore, India	www.acrex.in
March 10-14	ISH	Frankfurt, Germany	http://ish.messefrankfurt.com
March 18-21	AQUATHERM St.Petersburg	St. Petersburg, Russia	www.aquatherm-spb.com/en/
May 13-15	ISH China & CIHE	Beijing, China	www.ishc-cihe.com
September 23-25	ISH Shanghai & CIHE	Shanghai, China	www.ishs-cihe.hk.messefrankfurt.com
November 2-6	Interclima+Elec	Paris, France	www.interclimaelec.com

Conferences and seminars 2016

May 22-25	12th REHVA World Conference - CLIMA 2016	Aalborg, Denmark	www.clima2016.org
July 3-8	Indoor Air 2016	Ghent, Belgium	twitter @IA2016

Exhibitions 2016

January 25-27	2016 AHR Expo	Orlando, Florida, USA	www.ahrexpo.com
March 1-4	AQUATHERM Prague	Prague, Czech Republic	www.aquatherm-praha.com/en/
March 13-18	Light and Building	Frankfurt, Germany	http://ish.messefrankfurt.com
March 15-18	Mostra Convegno Expocomfort	Milan, Italy	www.mcxpocomfort.it/
October 12-14	FinnBuild	Helsinki, Finland	www.messukeskus.com/Sites1/FinnBuild/

International Conference

World Sustainable Energy Days 2015

25 - 27 February 2015
WELS, AUSTRIA

CONFERENCES:

-  **European Nearly Zero Energy Buildings Conference**
-  **European Energy Efficiency Watch Conference**
-  **Energy-Efficient Commercial Buildings Conference**
-  **European Pellet Conference**
-  **Young Researchers' Conference: Energy Efficiency & Biomass**
-  **Trade Show "Energiesparmesse"**
-  **B2B-Meetings**
-  **Technical site-visits**
-  **Poster Presentations**

The World Sustainable Energy Days are one of the largest annual conferences in this field in Europe, offering a unique combination of events on sustainable energy.

For more than 20 years, experts from all over the world have gathered in Upper Austria to attend the conference - in 2014, the event attracted over 750 participants from 59 countries.

The conference is held in parallel to the Energiesparmesse, a major trade show on energy efficiency and renewable energy, with more than 1,600 exhibitors and 100,000 visitors annually.

WWW.WSED.AT



REHVA SUPPORTERS

A REHVA supporter is a company or an organization that shares the same objectives as REHVA. Our REHVA supporters use the latest European technologies to make their products. The REHVA Supporters are also members of reHVAClub. For more information about REHVA supporters' program, please contact info@rehva.eu or call +32 2 5141171.





Register now for 2015!

To maintain the quality of the technical content of the REHVA European HVAC Journal, as of January 2015, REHVA will review its income structure and has decided to charge for a subscription to the REHVA journal. This will allow us to keep original format without including too many advertisements.

This is the result of the increasing cost of shipping and printing due to the high success of the journal. Furthermore, as of 2015, the REHVA Journal issues will be available in a restricted section of the website which incurred development costs. The current subscribers are offered two options:

1. Continue to receive the paper copy for the cost of **60€ per year for REHVA Members** or **70€ per year for others** and read the eJournal online in the restricted area .
2. Read the eJournal online in the restricted area for **30 € for REHVA Members** or **40€ per year for others**.

PLEASE SIGN ME UP FOR:

- 1 YEAR SUBSCRIPTION PAPER COPY AND ACCESS TO RESTRICTED AREA ON REHVA WEBSITE
- 1 YEAR SUBSCRIPTION PDF FORMAT (ACCESS TO RESTRICTED AREA ON REHVA WEBSITE ONLY)

Company:	Department:
Last name:	First name:
Address:	
Postal Code:	City:
Country:	
E-mail:	
REHVA-Member/National HVAC association name: :	
Signature:	Date:

Please, return the subscription form to REHVA office by mail, fax or email.

REHVA – Rue Washington, 40 - 1050 Brussels - Belgium
 Telephone: +32 2 514 11 71 - Telefax: +32 2 512 90 62
 e-mail: info@rehva.eu - website: www.rehva.eu

Payment

Via online secure credit card payment area (<http://www.rehva.eu/publications-and-resources/guidebooks-shop/>).

Via bank transfer: ABN AMRO Bank – Account number: 41.68.61.814 - IBAN: NL07ABNA0416861814 - BIC: AB-NANL2A

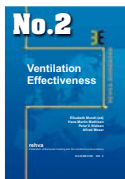

Ventilation Effectiveness. Improving the ventilation effectiveness allows the indoor air quality to be significantly enhanced without the need for higher air changes in the building, thereby avoiding the higher costs and energy consumption associated with increasing the ventilation rates. This Guidebook provides easy-to-understand descriptions of the indices used to measure the performance of a ventilation system and which indices to use in different cases.

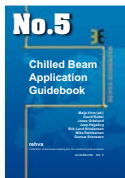

Chilled Beam Cooling. Chilled beam systems are primarily used for cooling and ventilation in spaces, which appreciate good indoor environmental quality and individual space control. Active chilled beams are connected to the ventilation ductwork, high temperature cold water, and when desired, low temperature hot water system. Primary air supply induces room air to be recirculated through the heat exchanger of the chilled beam. In order to cool or heat the room either cold or warm water is cycled through the heat exchanger.

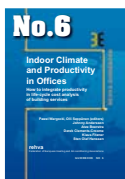

Indoor Climate and Productivity in Offices. This Guidebook shows how to quantify the effects of indoor environment on office work and also how to include these effects in the calculation of building costs. Such calculations have not been performed previously, because very little data has been available. The quantitative relationships presented in this Guidebook can be used to calculate the costs and benefits of running and operating the building.



Low Temperature Heating And High Temperature Cooling. This Guidebook describes the systems that use water as heat-carrier and when the heat exchange within the conditioned space is more than 50% radiant. Embedded systems insulated from the main building structure (floor, wall and ceiling) are used in all types of buildings and work with heat carriers at low temperatures for heating and relatively high temperature for cooling.

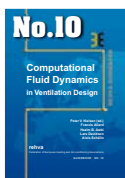

Computational Fluid Dynamics in Ventilation Design. CFD-calculations have been rapidly developed to a powerful tool for the analysis of air pollution distribution in various spaces. However, the user of CFD-calculation should be aware of the basic principles of calculations and specifically the boundary conditions. Computational Fluid Dynamics (CFD) – in Ventilation Design models is written by a working group of highly qualified international experts representing research, consulting and design.

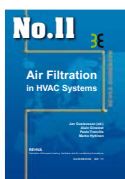

Air Filtration in HVAC Systems. This Guidebook will help the designer and user to understand the background and criteria for air filtration, how to select air filters and avoid problems associated with hygienic and other conditions at operation of air filters. The selection of air filters is based on external conditions such as levels of existing pollutants, indoor air quality and energy efficiency requirements.



Solar Shading – How to integrate solar shading in sustainable buildings. Solar Shading Guidebook gives a solid background on the physics of solar radiation and its behaviour in window with solar shading systems. Major focus of the Guidebook is on the effect of solar shading in the use of energy for cooling, heating and lighting. The book gives also practical guidance for selection, installation and operation of solar shading as well as future trends in integration of HVAC-systems with solar control.

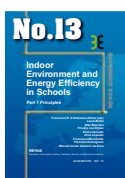

Indoor Environment and Energy Efficiency in Schools – Part 1 Principles. School buildings represent a significant part of the building stock and also a noteworthy part of the total energy use. Indoor and Energy Efficiency in Schools Guidebook describes the optimal design and operation of schools with respect to low energy cost and performance of the students. It focuses particularly on energy efficient systems for a healthy indoor environment.

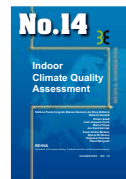

Indoor Climate Quality Assessment. This Guidebook gives building professionals a useful support in the practical measurements and monitoring of the indoor climate in buildings. Wireless technologies for measurement and monitoring have allowed enlarging significantly number of possible applications, especially in existing buildings. The Guidebook illustrates with several cases the instrumentation.

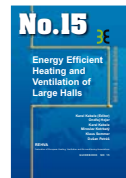

Energy Efficient Heating and Ventilation of Large Halls. This Guidebook is focused on modern methods for design, control and operation of energy efficient heating systems in large spaces and industrial halls. The book deals with thermal comfort, light and dark gas radiant heaters, panel radiant heating, floor heating and industrial air heating systems. Various heating systems are illustrated with case studies. Design principles, methods and modelling tools are presented for various systems.

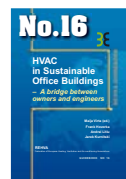

HVAC in Sustainable Office Buildings – A bridge between owners and engineers. This Guidebook discusses the interaction of sustainability and heating, ventilation and air-conditioning. HVAC technologies used in sustainable buildings are described. This book also provides a list of questions to be asked in various phrases of building's life time. Different case studies of sustainable office buildings are presented.

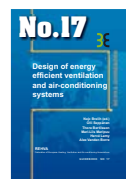

Design of energy efficient ventilation and air-conditioning systems. This Guidebook covers numerous system components of ventilation and air-conditioning systems and shows how they can be improved by applying the latest technology products. Special attention is paid to details, which are often overlooked in the daily design practice, resulting in poor performance of high quality products once they are installed in the building system.

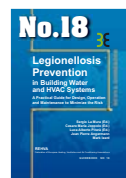

Legionellosis Prevention in Building Water and HVAC Systems. This Guidebook is a practical guide for design, operation and maintenance to minimize the risk of legionellosis in building water and HVAC systems. It is divided into several themes such as: Air conditioning of the air (by water – humidification), Production of hot water for washing (fundamentally but not only hot water for washing) and Evaporative cooling tower.



Mixing Ventilation. In this Guidebook most of the known and used in practice methods for achieving mixing air distribution are discussed. Mixing ventilation has been applied to many different spaces providing fresh air and thermal comfort to the occupants. Today, a design engineer can choose from large selection of air diffusers and exhaust openings.



Advanced system design and operation of GEOTABS buildings. This Guidebook provides comprehensive information on GEOTABS systems. It is intended to support building owners, architects and engineers in an early design stage showing how GEOTABS can be integrated into their building concepts. It also gives many helpful advices from experienced engineers that have designed, built and run GEOTABS systems.



REHVA nZEB Report. In this REHVA Report in cooperation with CEN, technical definitions and energy calculation principles for nearly zero energy buildings required in the implementation of the Energy performance of buildings directive recast are presented. This 2013 revision replaces 2011 version. These technical definitions and specifications were prepared in the level of detail to be suitable for the implementation in national building codes.