

# The ASHRAE Design Guide for Tall, Supertall and Megatall Building Systems



PETER SIMMONDS

Ph.D., ASHRAE Fellow and DL  
 Building and Systems Analytics LLC  
 Marina del Rey, California and Hong Kong  
[peter@petersimmonds.com](mailto:peter@petersimmonds.com)

The ASHRAE Design Guide for Tall, Supertall and Megatall Building Systems was produced in collaboration with the CTBUH. The design guide outlines various tall building mechanical systems that are presently being designed or are planned for the future. Tall commercial buildings in particular present a series of design problems that set them apart from other functions.

The Design Guide will be of interest to owners, architects, structural engineers, mechanical engineers, electrical engineers and other specialized engineers and consultants. This design guide addresses design issues for tall commercial buildings, which are very often mixed-use, and commonly consist of low level retail, office floors, residential units, and hotel uses.

**Keywords:** Façade, Code Compliance, Energy Efficiency, Climate, Integrated Design.

## Introduction

This design guide will be of interest to owners, architects, structural engineers, mechanical engineers, electrical engineers, fire engineers and other specialized engineers and consultants. The design guide not only focuses on the efforts of designers of the heating, ventilating and air-conditioning (HVAC) systems, but also addresses the importance of an integrated design team and their collective efforts and concerns that are the critical elements in determining the ultimate solutions to project needs of a tall building. The guide addresses design issues for tall commercial buildings which are very often mixed use, consisting sometimes of low level retail, office floors, residential floors and hotel floors.

So not only are our tall buildings taller but they have many different functions, each function being specific. The different functions will have different code requirements and with specifics such as life safety we are sometimes going into unknown territory, these items and various additional points will be presented in the design guide.

## Architectural Design

This chapter does not include any discussion on the aesthetics of buildings but will discuss possible core layouts and emergency egress routes and refuge floors, from an architectural perspective. Floor efficiencies will also be outlined.

Every building that has been designed and constructed must respond to real estate considerations if the project is to be a successful venture. These considerations include ownership issues as well as matters that are more appropriately a concern of the usage to which the building will be subjected. While of importance in all buildings, these matters are of even greater importance in tall commercial office buildings due to their size and the need for it to meet the additional requirements of its occupants. It is difficult to fundamentally alter a large building, after it is finished and available for use by occupants. So the building usage and performance criteria should be defined at the outset of design. An example of the information that would be included in the detailing of the design criteria for a tall building project is included in the preface.

An initial real estate consideration that must be recognized and dealt with is the nature of the ownership of the building. The ownership entity for whom a building is being constructed falls into several distinct categories, such as owner occupied, speculative leasing, co-op, condo, etc. These categories may overlap but generally they do not. There is often more than a single ownership category and the alternative categories may well affect the design solutions developed for any project.

Many tall commercial office buildings are corporate headquarters developed within a customized program, typically, by the architect and owner with significant input from a real estate consulting firm retained by the owner. The developed program will establish the specific requirements for the design team. For example, will the building contain a data center, if so how large and with what potential for expansion; what dining facilities are to be included; are there executive dining area requirements that are separate from the general employee dining; are the telecommunication requirements and possible technology vendors established; what areas beyond the data center will be operating on an extended time schedule or on a 7 x 24-hour basis? The answer to these and similar programmatic questions will all have a direct impact on the HVAC solutions that will need to be developed for the project, in addition, there are other significant issues which will have a major effect on the final design solution, such as core size, shaft space accommodations, efficiency of floor layouts, multiple mechanical equipment room floors, locations, louvers, etc.

### **Façade Engineering**

This chapter will not cover the structural engineering of a facade but will provide information on interpreting present day energy codes which present some stringent challenges for “tall, supertall and megatall buildings”

A high performance facade design is essential to minimize the solar cooling load and allow for efficient performance of air conditioning systems while enhancing indoor comfort and maintaining views (see **Figure 1**).

The facade should be designed to minimize the solar gain to 10 to 20% of the incident radiation.

Double skin facades achieve flexible operation through a combined system of components which are both known and used already allowing the regulation of heat, cold, light & noise in such a way that comfort is achieved with low energy consumption. Further they also provide an extra level of acoustic insulation and allow natural window ventilation via an intake of air into the cavity between the two layers of the facade - a set-up that can offer the appropriate level security required for night purging in some situations.

### **Climatic data**

The effect of ambient air temperature over the height of buildings, especially super tall and mega tall buildings is presented. The ambient climatic conditions vary with altitude and these changes in ambient conditions can seriously affect load calculations and performance of super and mega tall buildings.

The climate at 100 m above grade is not the same as 600m, examples of the difference in ambient conditions are included in the appendix. However, rarely does the design of upper level of the building capitalize on that difference. Further, wind conditions at the top of a tall building are different. If sufficient data is known about this difference, it can be incorporated into the design.

### **Stack Effect**

The existence of stack effect in tall commercial buildings has often presented major problems (see **Figure 2**). The problems most frequently manifest themselves in a difficulty in getting elevator doors to close and in difficulty in heating lower levels of the building. The elevator doors' failure to close properly is due to the pressure differential across the doors which, in turn, causes the door to bind in its guide way to the degree that the closing mechanism for the elevator doors does not generate sufficient force to overcome the binding effect. The heating problems are due to the substantial influx of cold air through the doors at the entrance level itself and across the outside wall of the building due to the higher permeability of the wall than is the design requirement of the specification for the wall.

## Indoor Air Quality and Thermal Comfort

The ventilation requirements for commercial and institutional buildings are given in ASHRAE Standard 62-1. These ventilation rates were chosen to achieve an acceptable level of indoor air quality by control of carbon dioxide, particulates, odors, and other contaminants common to those spaces. If cleaned re-circulated air is used to reduce the indoor air below the recommended values, the Indoor Air Quality Procedure must be used. The requirements are given in terms of cfm of ventilation air per person, or per square foot of floor area.

### Thermal comfort

In traditional designs, the HVAC designer's role in achieving comfort conditions often begins and ends at the selection of an indoor design condition and the sizing of the HVAC system to provide these conditions at peak load. The selection of a design dry-bulb condition involves both comfort and cost or energy considerations and can dictate critical design features of the system. For example, some designers may pick a relatively high design cooling condition such as 26°C in order to conserve energy, while others may select one such as 22°C in order to maximize the number of satisfied occupants. Selecting systems and controls that perform efficiently at part load can mitigate the energy downside of the latter.

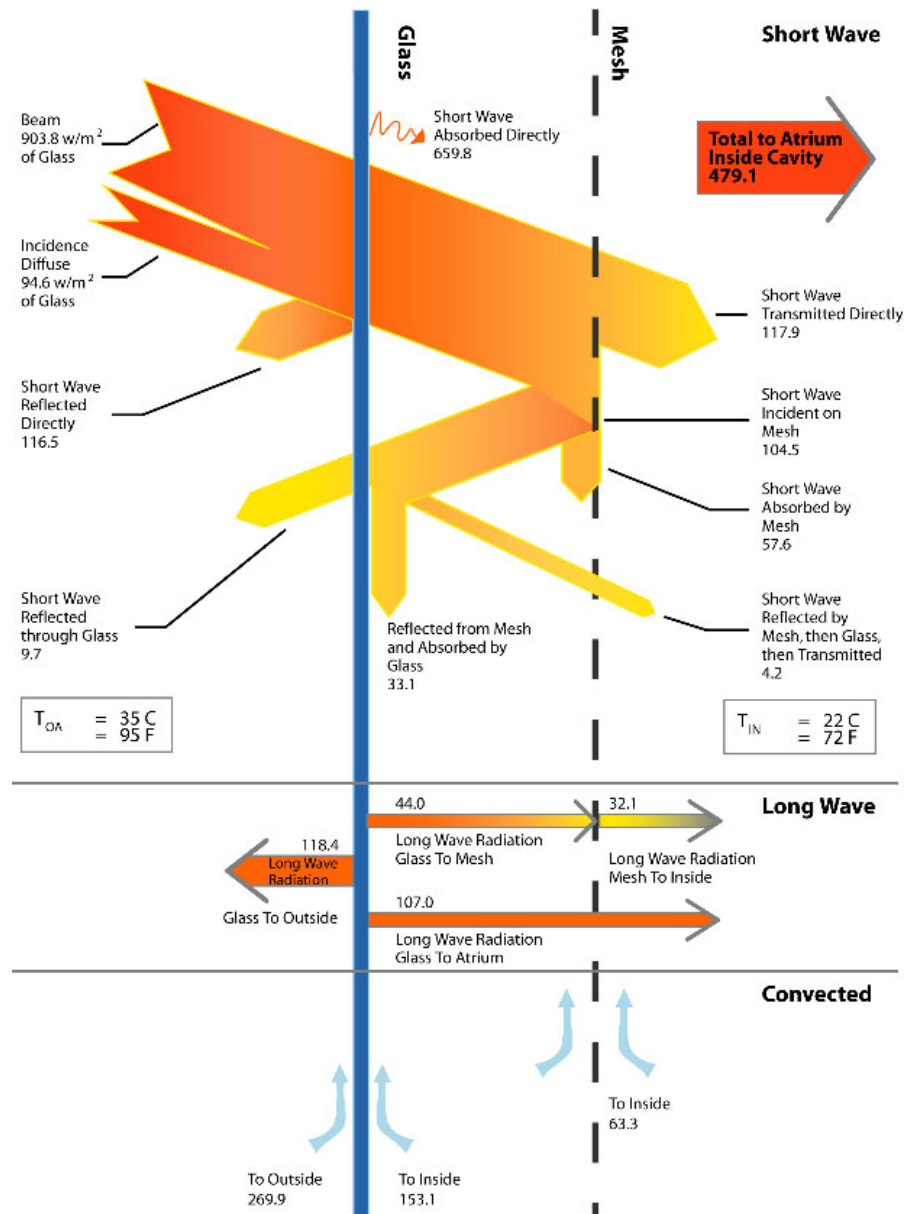

**Figure 1.** Sankey diagram of a high performance facade construction.

Please check this image in better resolution on the REHVA Journal digital version.

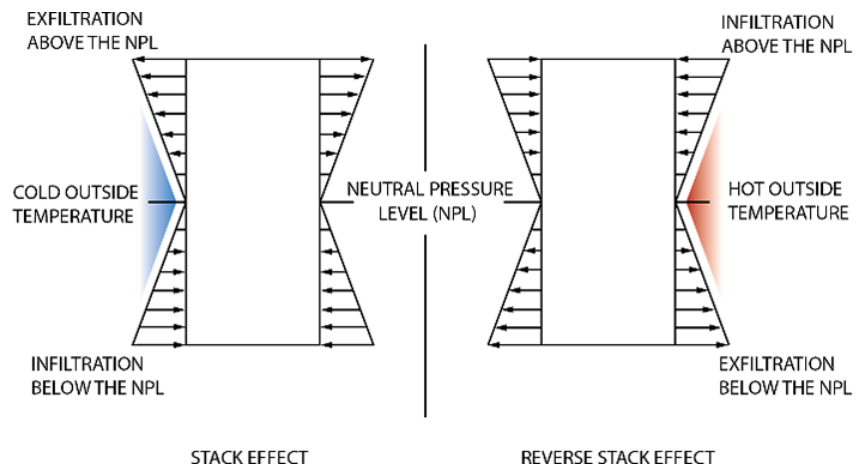

**Figure 2.** The diagrammatic effects of stack for both summer and winter.

Please check this image in better resolution on the REHVA Journal digital version.

Thermal conditions indoors, combined with occupant activity and clothing, determine occupant thermal comfort, which in turn impacts occupant productivity and perceptions of air quality. Dry-bulb temperature is only one physical parameter out of many that interact in a complex manner to produce occupant satisfaction.

Thermal conditions affect chemical and biological contaminant levels and/or the intensity of occupants' reactions to these contaminants, but our knowledge of these effects and their mechanisms is very limited. Despite this limited knowledge, achieving high performance in thermal comfort is likely to result in lower contaminant levels and better occupant perceptions of IAQ.

### *Adaptive comfort*

For naturally ventilated buildings and buildings operating in “free-running” mode the indoor comfort temperature was also noted to strongly correlate with the mean monthly temperature outdoors at the time of the survey. This concept suggests that people are able to adapt to the wider range of thermal conditions than is generally considered before. For instance, human can tolerate higher temperature even feel more comfortable when they are under hotter environment. In addition, ASHRAE 55-2013 adapts mean monthly outdoor air temperature to evaluate the indoor comfortable operative temperature.

### **HVAC systems**

The systems that have found application in tall commercial buildings have evolved over the past decades in response to the changes in the perceived goals of the entity that is constructing the building, the expanding needs of the potential occupants be they a corporate end user or a leasing party, and the concerns of the owner with the availability and the cost of energy and the resultant expenditures necessary to operate the building. More recently, the import of environmental concerns, including indoor air quality and the growing challenge to provide safer buildings, has further influenced the approach that is taken in the system selected for a modern tall commercial building.

To meet the challenge of providing systems that address these major issues, the commercially available equipment and the deployment of that equipment have also gone through a period of modification in some design details over the recent past. This process of evolution will undoubtedly continue in the future but the basic general system categories that are available today that are discussed in this chapter will undoubtedly continue

to find wide usage in the tall commercial building, such as VAV systems (see **Figure 3**), Fan Coils, Radiant Ceilings, Radiant Floors, Displacement Ventilation and Underfloor Air Distribution. It is the technical details of the system design that have been and will be subjected to ongoing modification.

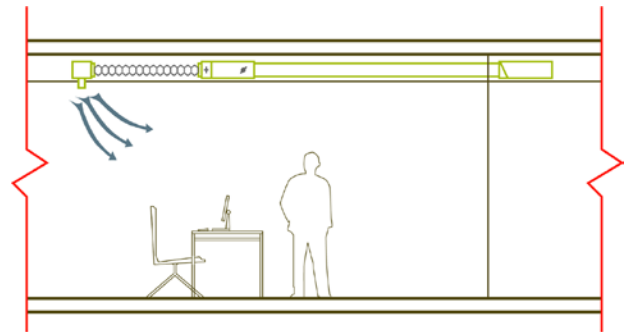

**Figure 3.** A diagram of a typical overhead VAV system.

*Please check this image in better resolution on the REHVA Journal digital version.*

### **Central Mechanical Rooms and Floor by Floor Fan Rooms**

A major decision that must be made by the entire project team in a tall commercial building is whether to meet the project needs for conditioned air through air conditioning supply systems installed in a central mechanical equipment room serving multiple floors or by systems installed in a separate local floor fan room located on each floor supplying air only to the floor on which the system is installed. The choice from any of the two alternative schemes is one of the most fundamental decisions that must be made during the conceptual design phase. It is an issue that concerns the owner, each member of the design team, and the constructing contractors who will erect the building from the completed design documents.

The decision, therefore, is one that requires full consideration and detailed input from the entire project team, including the contractors who will be implementing the project designs. While frequently the decision is predicated on what is being done on competitive projects in the same real estate market and may reflect the bias of one or more of the deciding members of the project team, it is possible to establish points of comparison that can be discussed with relative objectivity to allow the decision to be made in a proper manner.

### **Central Plants**

Typically, tall buildings have central plants in order to increase the efficiency of the cooling and heating

systems as well as providing a redundancy of equipment (see **Figure 4**). It is advantageous to situate the chiller plant in a close proximity to an electrical substation. Cooling towers cannot always be situated on a roof 600m above grade, so creative solutions need to be employed. In some cases, air cooled equipment is used and this creates the opportunity of situating air cooled equipment on refuge floors, for instance.

Boiler plants are usually located in basement areas, although many have been installed on roofs or sometimes on refuge floors. However, a solution to the flue exhaust must be found.

### Water Distribution Systems

The design of water distribution systems for a commercial tall building differs from the design of these systems for a low-rise building primarily due to the static pressure on the piping system as a result of the height of the building (see **Figure 5**). This condition can affect the design of all of the piping systems in the building, including the domestic water piping and sprinkler systems, but the Design Guide only addresses the chilled water, hot water and condenser water systems.

### Energy Modeling and Building Performance

Energy simulation can provide the design team with information regarding the building massing and orientation. In a first concept and it provides clear guidelines as to the massing of the building and the orientation to improve its thermal and natural daylight capabilities.

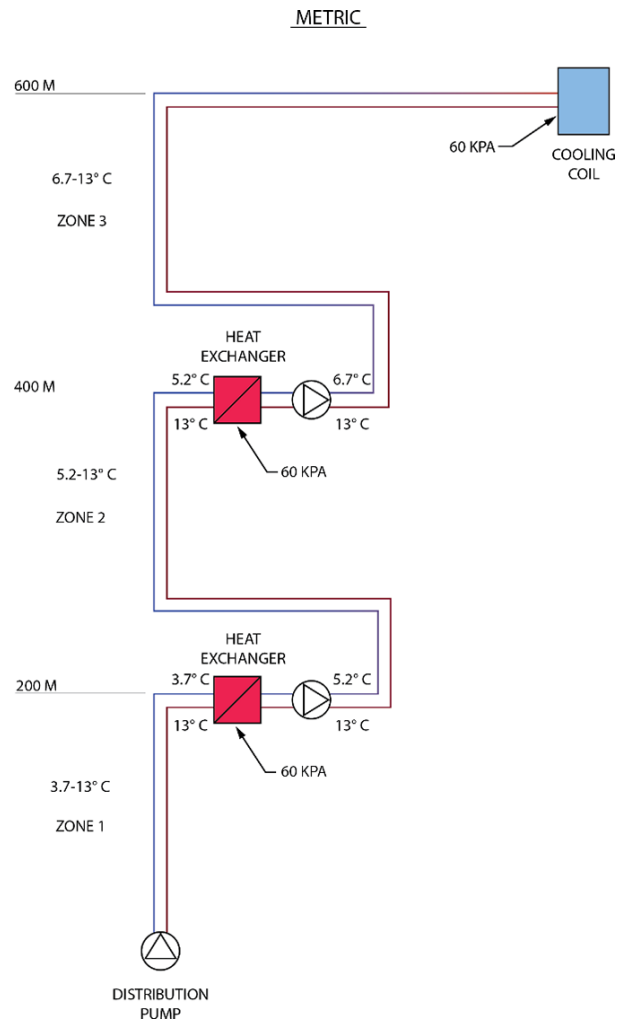

**Figure 5.** A diagram of a chilled water distribution system for a 600m building where the distribution is split into three parts to regulate static pressure.

*Please check this image in better resolution on the REHVA Journal digital version.*

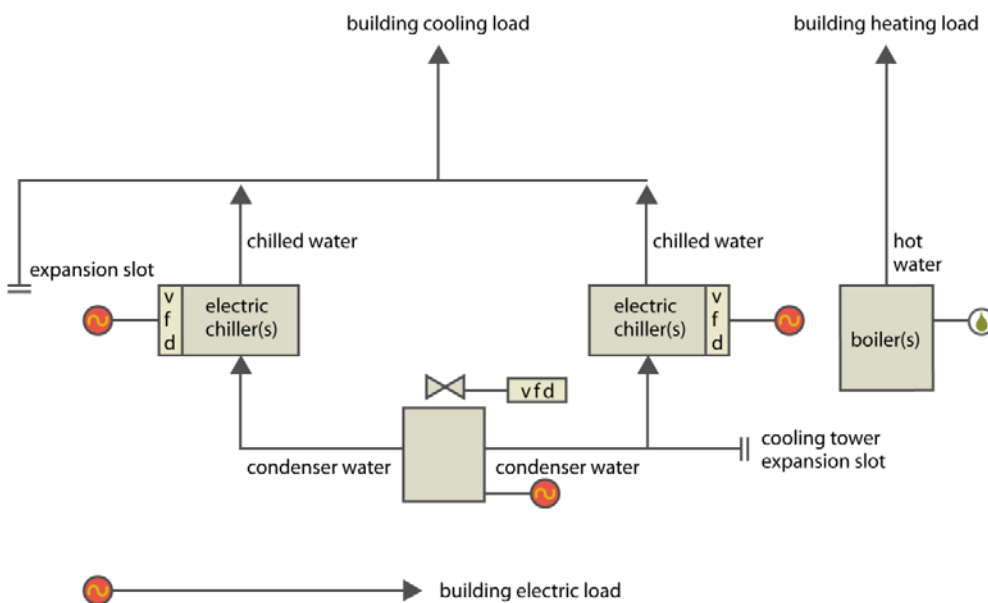

**Figure 4.** A diagram of a typical central plant for heating and cooling.

*Please check this image in better resolution on the REHVA Journal digital version.*

This information would also include information on preliminary energy goals for the building as by ASHRAE 90.1 and other applicable codes, such as China Energy Codes. By setting goals the design team can also outline possibilities in providing efficient building design solutions that consume less carbon than the goals. A preliminary report should include any relevant solutions or possibilities for the building and its systems at the same the report should remove any systems that are not feasible to minimize the alternatives so as not to tax the available budget. With the relevant simulation programs guidance can be provided at any early stage on glass types and systems, for example. The next plan as the project develops is to analyze the buildings performance using simulation programs. Once the base case has been determined energy conservation measures can be assessed. When the base case and alternatives have been developed, probably the most difficult stage emerges, obtaining costs for the different alternative (see **Figure 6**).

At the concept phase it should be possible to define an engineering solution for a building design. The energy consumption of alternatives can be translated into reductions of utility costs and probably more important be translated into reductions of CO<sub>2</sub> consumptions. Carbon trading has begun to emerge although not wholly known by most clients and will continue to develop into energy carbon trading and a reduction of carbon consumption.

### Vertical transportation systems

Vertical transportation has improved dramatically in the past 10 years, not only due to the different building types in tall buildings but also lift technology

and logistics of people movement. The construction of tall buildings only became possible with the development of the elevator safety braking system and the elevator itself, with the resulting ability to move people expeditiously through the multiple levels of a tall building. Generally, the HVAC designer does not have a significant involvement with the elevators as they are installed in a building other than to provide cooling in the elevator machine room to ensure that the controlling electronics of the elevator system are maintained at an appropriate temperature to allow their reliable operation and, as discussed subsequently in this chapter, if required by code, to vent the elevator shafts and the elevator machine room to atmosphere. In Tall, Supertall, and Mega tall buildings however the final core design generally results in one or more elevators confined within a single shaft. This creates significant problems with respect to “piston effect” caused by the compression of the column of air ahead of the elevator, and “stack effect”, either positive or negative, depending on the time of year or climatic conditions of the region.

### Plumbing systems

The plumbing systems designed for any building fall into several discrete categories including the domestic water system, which will provide both hot and cold water to various fixtures and water-consuming equipment installed throughout the building; the sanitary system, which will be connected to water closets, lavatories, drains, etc., in the building and will drain the waste from these fixtures to a sewer system external to the building; and a storm water system, which will collect rain water or melted snow and pipe it to an appropriate disposal point, usually a public sewer.

Plumbing systems also includes information on traditional plumbing systems but also specifics such as grey and black water systems.

### Life safety systems

Every tall commercial building that is constructed should include design details and operating systems that, in total, will constitute a life safety system. The requirements for both the design details and operating systems that should be included will be defined in the building code that applies in the jurisdiction within which the building will be located. The building code should address construction details

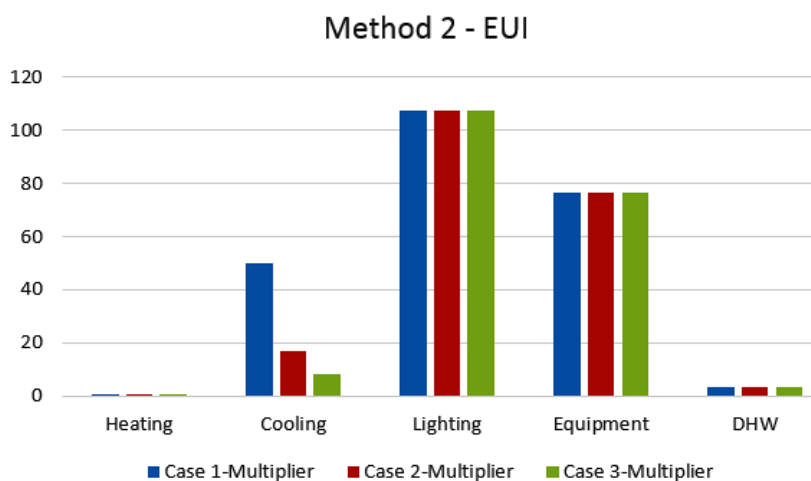

**Figure 6.** EUI results obtained from an energy simulation comparison.

Please check this image in better resolution on the REHVA Journal digital version.

of the building; should outline minimum criteria for the means of egress from the building in the event of a fire or other emergency; and should specify protective features and systems that must be included to achieve the level of protection that can reasonably be provided to allow adequate egress time and protection for building occupants who may be exposed to a fire or the smoke generated by a fire.

### High Rise Residential

High Rise residential faces more scrutiny than a lower-rise development owing to its visibility in the urban landscape. Architectural quality and iconic architecture are often cited as the main contributors to the success of the planning applications. But there are other specifics of residential spaces that need to be resolved, such as:

- Floor plate efficiency: The shape and geometry of other building parts such as offices or hotels, need to be coordinated with residential shapes and areas.
- Conditioning systems. Fan coils (see **Figure 7**) or heat pumps can be employed or other systems such as Radiant floors for heating cooling, active beams or even centralized systems. A solution has to be found for supply and extract riser ducts.
- Many residential spaces can be naturally ventilated.

How is this integrated into a mechanical system to become a “mixed mode system”? What about the effect of natural ventilation on the buildings stack effect and what about considerations of the fire department when there are open parts to the building envelope?

- special exhaust systems for washers and dryers
- Differences required for condominiums and apartments
- Electrical metering of each individual unit
- IT and Wi-Fi for all units

Many high rise residences are part of mixed use buildings. The tower may have residential floors, hotel floors, office floors, etc. The core design is very often different for each specific application, also the smoke control is often complicated as occupants do not want to be used by another building use.

### Electrical System Interfaces

Typical multi use buildings will have multiple electrical feeds, there will be a normal power supply from the local utility company and an emergency supply from standby generator sets or standby power from batteries. For many modern buildings tenants often require space for their own standby generators.

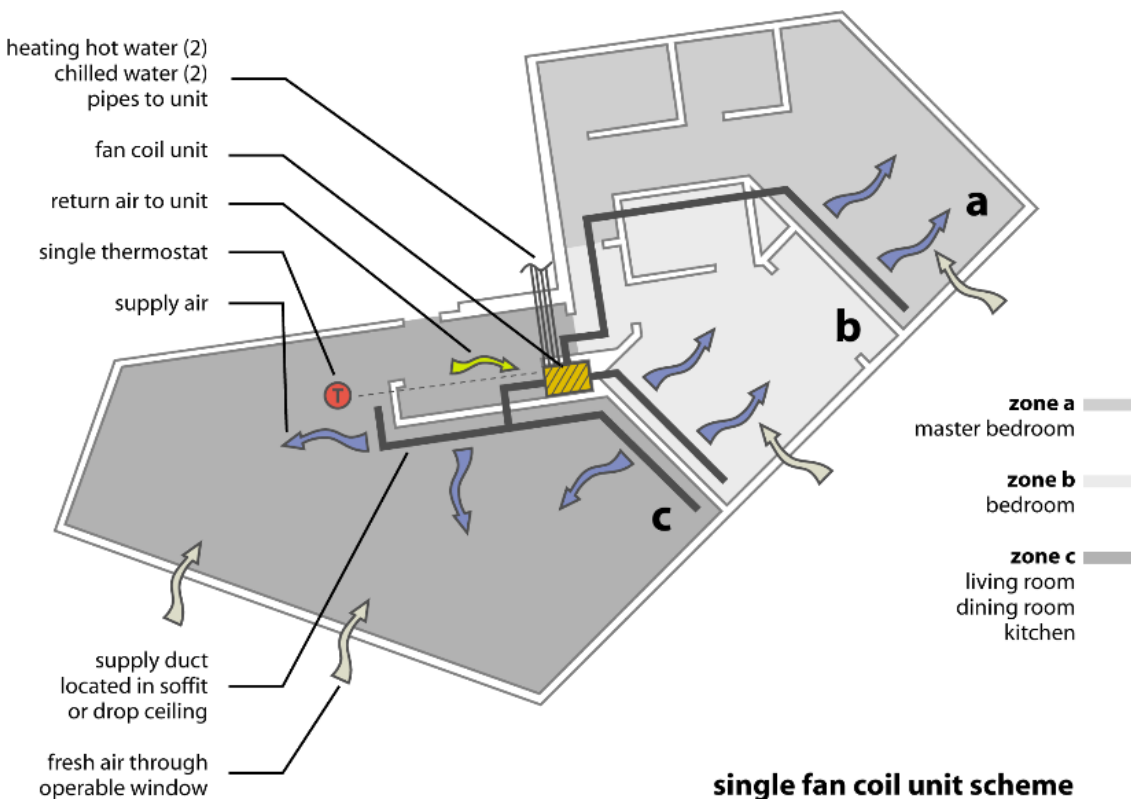

**Figure 7.** Typical fan coil conditioning system for a residential space.

Please check this image in better resolution on the REHVA Journal digital version.

The utility company provide medium of high voltage power (typically 11kV to 66kV) to sub stations. Multiple sub stations are used to provide power from multiple sources within the building to provide redundancy. Utility power can be metered at sub stations with main switchgear usually placed in basement areas. It is normal to have multiple main switchgear which are isolated from each other and usually in different fire compartments.

Utility companies can have specific requirements for sub stations and switchgear. Sometimes there can be no specific requirements and sometimes there can be many specific requirements which are determined by the utility company, such as installing substations and switchgear against outside walls

### Intelligent Building and Controls

When designing tall, supertall and Megatall buildings it is also essential to operate the buildings systems so the least amount of energy is consumed. The integration of smart building systems will increase the buildings efficiency and also provide more insight into the operation characteristics of the building. Maintenance of these large buildings can also be reduced by the introduction of automated fault detection and diagnostics in the building management system.

Smart building systems are building components that exhibit characteristics analogous to human intelligence. These characteristics include drawing conclusions from data or analyses of data rather than simply generating more data or plots of data, interpreting information or data to reach new conclusions, and making decisions and/or taking action autonomously without being explicitly instructed or programed to take the specific action. These capabilities are usually associated with software, but they can also be possessed by hardware with embedded software code or firmware. The line between systems that are smart and not smart is blurry, and for purposes of the chapter does not need to be absolutely defined. The purpose of this chapter is to introduce readers to emerging technologies that possess some of these “smart” characteristics.

These emerging smart technologies offer opportunities to reduce energy use and cost, while improving the performance of HVAC systems to provide better indoor environmental quality. Achieving these benefits requires knowledge of these emerging technologies. The chapter covers smart systems and technolo-

gies in the fields of automated fault detection and diagnostics, sensors and actuators, and the emerging modernized electric power grid and its relationship to buildings and facilities. ■

### References

ASHRAE/IESNA Standard 90.1-2013: “Standard 90.1 Energy Efficient Design of New Buildings (Except Low-Rise Residential)”, American Society of Heating, Refrigerating, and Air-conditioning Engineers, Atlanta, Georgia.

Kohn, A. Eugene and Katz, P. “Building Type Basics for Office Buildings,” John Wiley & Sons, Inc., New York, 2002.

ASHRAE (2013). Fundamentals. American Society of Heating, Refrigeration, and Air Conditioning Engineers, Atlanta, GA.

Council on Tall Buildings and Urban Habitat (CTBUH). “The Skyscraper Center.” Accessed on March 26, 2015.

The ASHRAE Design Guide for Tall, Supertall, and Megatall Building Systems 2016 is currently available at the ASHRAE Bookstore [www.ashrae.org](http://www.ashrae.org).

### About the author

Peter Simmonds has more than 35 years of experience in the design of HVAC systems for large and complex projects in the United States and overseas, including airports, museums, tall, super tall and megatall buildings, universities, hospitals and laboratories. Utilizing his own specially developed design and control techniques with designs representing the latest technology in improving thermal comfort, building performance and low energy usage, he has contributed innovative design solutions to many low and zero-energy efficiency projects.

Peter currently teaches at the University of Southern California, and is a lecturer for the Swegon Air Academy. In 2011 Peter was named an ASHRAE Distinguished Lecturer.